

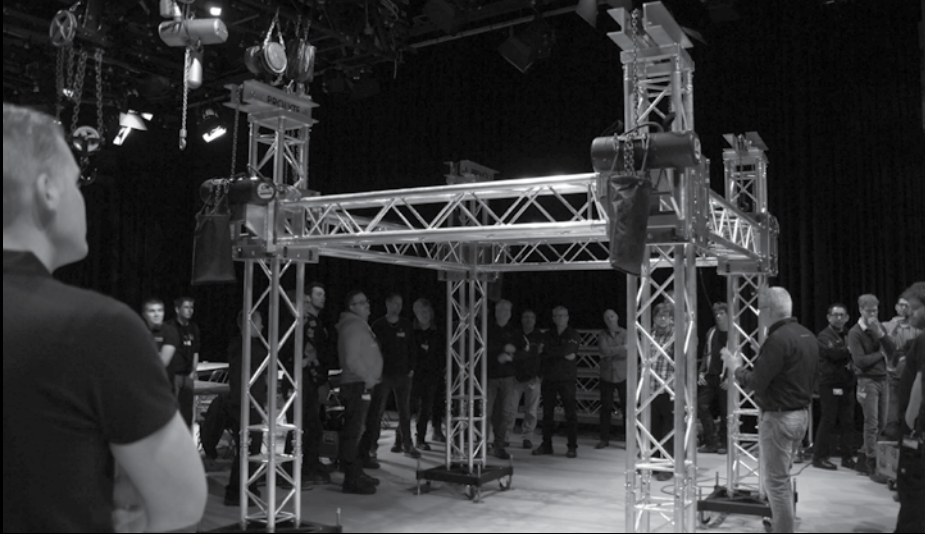

Blackbook contents

- INTRODUCTION
- 1. TRUSS 6
 - 1.1 MATERIAL 7
 - 1.2 STRAIGHT TRUSSES 7
 - 1.3 CORNER MODULES 22
 - 1.4 CIRCULAR TRUSS 26
 - 1.5 VERTICAL TRUSSES 30
 - 1.6 TRUSS STRUCTURES 34
 - 1.7 USE OF TRUSS 36
 - 1.8 RULES 49
 - 1.9 TECHNICAL PROPERTIES OF PROLYTE TRUSS 53
- 2. WHICH HEIGHT IS WHICH? 67
- 3. PROLYTE ROOF AND OUTDOOR STRUCTURES 71
- 4. PERFORMER FLYING 82
- 5. PERSONAL SAFETY EQUIPMENT
IN THE ENTERTAINMENT INDUSTRY 84
- 6. RULES FOR APPLICATION 88
- 7. PROLYTE CAMPUS 91
- NOTES 92



Controllux, Prolyte Campus event in Netherlands

Basic Technical Information

This BlackBook contains basic technical information about our trusses and complementary products.

We are looking at our products with their technical properties, their potential, their practical limits, experience gained in more than 25 years in the entertainment industry and the state of scientific and technical knowledge.

We are aware that this information is basic knowledge and cannot cover all areas and future developments.

However, although this documentation is not exhaustive, we believe it provides a good introduction to our products. All information complies with the latest standards and developments in the beginning of the year 2023. The compositions and



designs for aluminium trusses are described, as well as the different types of connections, forces within the trusses and the different types of loading. We will discuss standards, regulations and laws relating to trusses, followed by calculation methods, loading tables and rules of thumb. Furthermore we describe stages, roof systems, hoisting of truss, lifting people, truss maintenance, criteria for rejection and discard, and accepted practical rules. In our opinion, good customer service consists primarily in continuously improving the information available to

users. This means that we are facing changes in the way we look at things in the evolution of the Prolyte BlackBook since its first release in the year 2007. Better and appropriate use of our products is of great benefit to our customers and to us as manufacturers. In the long term this means enhanced safety, enthusiastic customers and greater awareness of users when working with our products. Our prime objectives are quality and safety, this applies not only to our products but also to the associated information. Both are key to a successful and safe product range.

© 2023 PROLYTE BV.

All rights reserved. No parts of this catalogue may be reproduced or published in any form or in any way, by print, photo print, microfilm or any other means without prior written permission from Prolyte BV. Though compiled with due care, no representation is made as to the truth or accuracy of measurements, data or information contained herein. Prolyte disclaims any liability for damage, losses or other consequences suffered or incurred in connection with the use of the measurements, data or information contained herein.

We reserve the right to alter products, codes and technical information without prior notice.

1. TRUSS

When the first lattice spans appeared in event technology in the 1970's, hardly anyone would have described a truss as the following: 'A modular structural element made of aluminium tubes welded to each other, used to create temporary supporting structures for lighting and audio equipment used in entertainment technology.' At that time anything was used, from round steel tubes to antenna masts or riveted angle profiles. The word truss or lattice girder used to describe the wooden framework structure that was used to build houses, roofs, bridges or medieval cathedrals. The development of trusses as we know them today began towards the end of the 1970's when the entertainment industry was searching for a simple and efficient means of manufacturing light but safe supporting structures.

Designers used know-how about spatial structures employed in bridge construction to develop today's products. Apart from the bearing capacity, other practical considerations are important when developing trusses.

A truss is defined as:

- A spatial lattice beam
- Made from welded profiles like round and square tubes.
- Composed of modular coupled parts.
- Manufactured in several standardised lengths.
- Used to support equipment in the entertainment industry.
- Supported or suspended at almost any desired point.

Prolyte trusses are made of aluminium because:

- Aluminium has a self-weight ca. 65% less than steel.
- Aluminium is corrosion resistant and therefore requires less maintenance and no protection against corrosion.
- Aluminium has a relatively high tensile strength.
- Aluminium has an attractive appearance due to its natural lustre.
- Aluminium is 100% recyclable.

All trusses should have the following properties:

- Rigidity and stability appropriate for the intended use.
- A simple, reliable and quick connection system.

- Easy to handle thanks to light, compact elements.
- Efficient for application, transport and storage purposes.
- Multiple application possibilities.
- Basic information available to users on allowable load bearing capability and deflection provided in tables and diagrams.
- Robust and reliable connection parts.

Trusses are available in various geometric profiles: two-chord truss (ladder), three-chord truss (triangle), four-chord truss (square, rectangle or trapeze). There are considerable differences between these profiles which are decisive for:

- Safety: structural rigidity and stability.
- Cost effectiveness: efficiency for connecting, storage and transport.
- Multiple applications: a broad range of uses for various construction designs with a special truss type.

Each of these designs has its specific advantages and fields of application. The user should carefully consider the intended purpose before selecting a system.

Prolyte manufactures trusses for almost all applications in event technology, from decorative trusses of the E-series for shops and displays, to universal trusses for trade fairs, exhibition stand construction and rental, to heavy duty trusses for the high standards of the events and stage building industry. Although a fairly young product, trusses have become an indispensable product for the contemporary event industry.

Trusses are manufactured in standard lengths which can be combined to provide any overall length required. It is not usual to manufacture large truss lengths in one piece, since this would make them unmanageable for handling, transport and various other applications.



1.1 MATERIAL

The most common alloy used for the manufacturing of trusses is EN-AW 6082 T6. The chemical composition of the alloy EN-AW-6082 is AlMgSi1. EN indicates that the alloy is defined in a European standard. AW indicates that the Aluminium has been wrought. T6 indicates that the alloy is solution heat-treated and artificially aged, which is a heat treatment process to increase the strength of the alloy. Unfortunately, the repeated application of heat during welding reduces the tensile strength of the basic material in a zone around the weld. This zone is called the heat affected zone (HAZ). The size of the HAZ and the remaining residual strength as well as workpiece geometry and many other parameters are also determined by the welding process itself (e.g. MIG and WIG).

1.2 STRAIGHT TRUSSES

1.2.1 Components of truss

Why is a triangular shape the most dominant feature of a truss? A triangle is the only geometric shape which retains its shape when it is exposed to a load of weight at the connection points or joints, even if those joints are hinged. Only if one side is deformed (elongated, compressed, rolled) a triangle will lose its shape.

The behaviour of a triangular structure under load is easy to calculate and predict if the loads are exerted only in the nodal points.

Each side of a triangle should only be exposed to compression or tensile forces. Since no other influences such as bending forces are assumed, loads should be directed into the nodal points.

It should be emphasised that a truss without diagonal members in one or two sides may not be suitable for the same types of load as trusses with diagonal members on all sides. For example, this applies to the truss series H20V, S36R, S52F, S52V, S66R, S66V, S100F and all kinds of two-chord-trusses.

Without consulting a structural engineer it means that forces should always act in a plane with a diagonal lattice pattern of a truss.

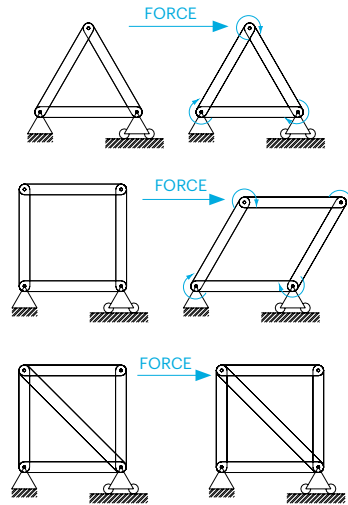

The triangle is the only geometric shape that retains its form when being loaded at the joints.

The basic elements of a truss are:

- Main chords
- Members, diagonal, internal or at right angles to the main chords.
- Connectors and connecting elements

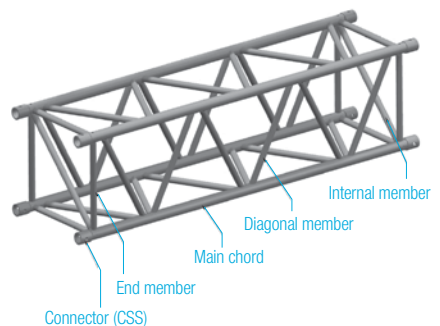

1. TRUSS

Fool proof assembly

All Prolyte trusses are designed as ready-to-use modules with terminated lattice structures. The end braces terminate the lattice structure of all truss modules. A single truss module of a sufficient length can be used as a load bearing element on its own. Truss modules can also be connected to form longer truss spans without the loss of structural integrity and without the need to pay respect to the continuity of the lattice structure.



Fool proof assembly for your convenience

Understanding the Prolyte article code terminology is a decent challenge. Even in our main catalogue we cannot explain all details. Please find a few examples to explain the basics:

H30V-L300, a very common straight truss module, known to most Prolyte users.

Indicator	Explanation
H	Main chord 48x3mm
30	Rough height of the truss 30cm, exact height is 287mm, Members are 16x2mm
V	Four-chord truss, square cross section
L	Straight truss module
300	Length is 300cm

X30D-R250-8, a lightweight truss circle.

Indicator	Explanation
X	Main chord 51x2mm
30	Rough height of the truss 30cm, exact width is 290mm, exact height is 258mm, members are 16x2mm
D	Three-chord truss, triangular cross section
R	Circle truss module indicated by outer radius
250	Outer radius is 250cm, outer diameter is 500cm
8	Circle is cut into 8 pieces of 45°, the rough length of the module is $2 \times 250\text{cm} \times \pi / 8 \approx 196\text{cm}$

H40V-C003, a simple corner module.

Indicator	Explanation
H	Main chord 48x3mm
40	Rough height of the truss 40cm, exact height is 387mm, Members are 20x2mm
V	Four-chord truss, square cross section
C	Corner truss module
003	Prolyte code for a two-way corner module, length of legs in 40-series is 60cm



CCS6-600, conical coupler.

Indicator	Explanation
CCS	Conical Connection System
6	Size for X-, H- and S30T and S40T Series
600	Prolyte code for conical coupler

T-48-CC150CC, single tube with conical connectors

Indicator	Explanation
T	Single round tube, straight
48	Tube cross section is 48x3mm
CC	Conical connector welded to one side
150	Length is 150cm
CC	Conical connector welded to other side

1.2.2 Forces and reactions

Trusses are subject to different forces. We have to distinguish between external and internal forces.

External forces are quite easy to understand. They are imposed through external actions on the truss. External forces are generated by:

- Payloads such as lighting fixtures, speaker cabinets, LED screens, cables, curtains, drapes, etc.
- Self-weight
- Dynamics caused by starting and stopping of lifting operations
- Environmental actions like wind, snow or ice

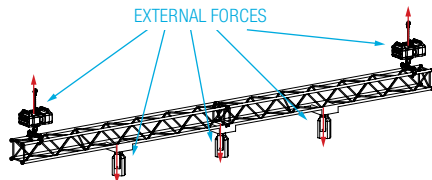

Internal forces are a little more complex to understand. We can define internal forces as reaction forces of the truss due to external forces. These internal forces can be

defined inside a particular section of a truss or inside a particular section of a truss structure.

The maximum amount of internal forces a truss can withstand is determined by the strength of the material of the truss and the orientation and position of its components. If external forces would generate internal forces exceeding the maximum internal forces the truss can withstand, the truss would fail.

In the following we will look at the internal forces of a truss by using examples for external forces from daily practice and how to increase the capacity of a truss by modifying its components.

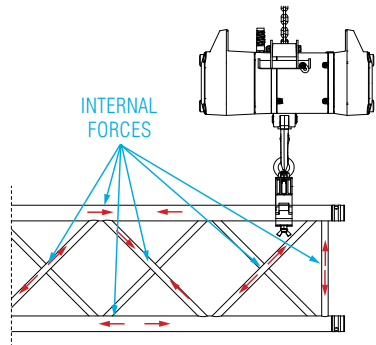

Normal force in a truss

1. TRUSS

Normal force

The normal force is a force which acts longitudinal to the centre line of the truss and its main chords and members.

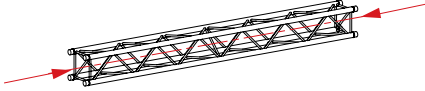

Normal force in allowed main chords and members

The maximum allowed normal force of a truss is determined by the main chords and the connections of the truss. After identifying the limiting component, the maximum permissible normal force can be increased by increasing the diameter of the main chord, increasing the wall thickness of the main chord or by reinforcing the connections of the truss. For the daily practice this would mean to use a stronger type of truss.

Bending moment

An external force acting on a truss will cause the truss to deform. The most likely deformation is bending. If we look at the simple system of a cantilever, a force acting on the free end of the cantilever would cause the truss to bend. The so-called bending moment is determined by multiplying the amount of force in Newton and the length of the cantilever in metre. The result will be the present bending moment given in the unit of Newtonmeter (Nm).

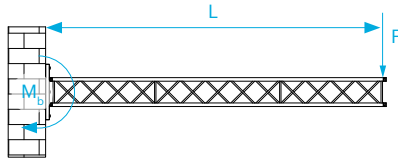

Cantilever lengths L , Force F , Bending moment M_b Formula $M_b = F \times L$

If we look at a simple example from daily practice like a truss on two suspensions, a single span, we find a little more complex formula but the same parameters: force, length, bending moment.

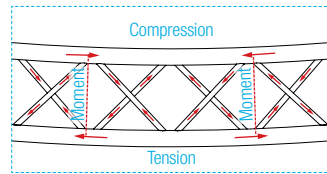
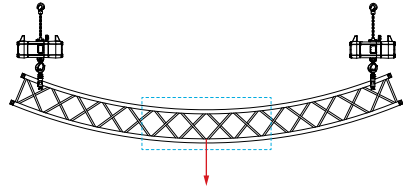

The bending of a truss causes normal forces in the main chords. In a single span truss the normal force in the top main chords acts as a compression force and as a tension force in the bottom main chords. The diagonal members are used to maintain the distance between the top and bottom main chords and will also be subject to normal forces in either tension or compression. The maximum allowable bending moment of a truss is determined by multiplying the sum of the maximum allowable normal forces in the top chords by the system height of the truss.

The maximum allowable bending moment can be increased by choosing truss with a larger system height or by increasing the allowable normal force in the main chord, by increasing the diameter of the main chords, by increasing the wall thickness of the main chord or by reinforcing the connections of the truss.



Photo: Prolyte

The main chords of a truss can also be subject to a local bending moment, this can be caused by eccentricity at the node points or by placing loads between the node points.

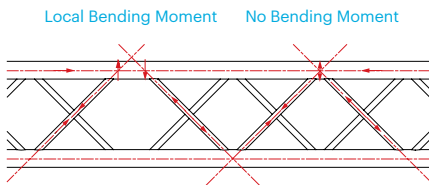

Local bending moment caused by eccentricity at node point

Eccentricity at the node points is not impermissible and sometimes unavoidable. If it exists, it needs to be taken into account in the structural report of the type of truss.

Placing loads at the main chords between node points is possible to a decent amount. The maximum amount of load needs to be calculated individually in accordance with the overall loading of the truss. Therefore the universal allowable loadings of single main chords are quite low.

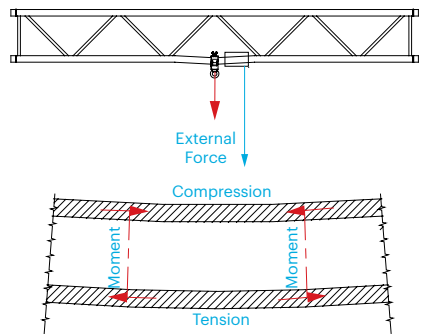

Local Bending Moment caused by external force between node points

1. TRUSS



Photo: Prolyte, Leek, The Netherlands

Transverse force (shear force)

The transverse force is the force which works perpendicular to the centre line of the truss.

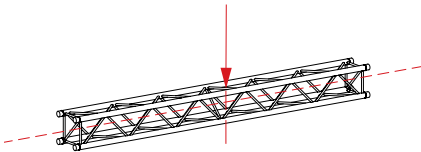

The transverse force causes normal forces in the diagonal members and shear force in the main chords of a truss. The normal forces in the diagonal members can be either compression or tension forces. The shear force on the main chord tries to 'cut' the main chord. Since the diagonal members are usually smaller and thereby weaker than the main chords, the diagonal members are limiting the maximum transverse force a truss can take. The maximum transverse force can be increased by increasing the diameter and/or the wall thickness of the diagonal members.

Torsion force

The torsion force works rotary to the centre line of the truss and tries to twist the truss. Torsion forces are difficult to determine and should be avoided or compensated by applying counterweights without overloading the truss.

Examples of situations where torsion force will occur:

- Equipment on a boom arm.
- Equipment all positioned on one side (main chord) of a truss.
- Live loading on a central span in a ground support system.

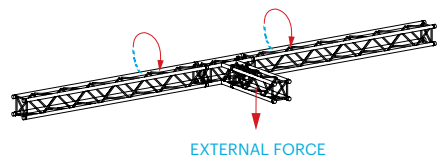

Torsion force at the rotating arrows



Deflection

The deflection of a truss shows the bending forces at work. Deflection is defined as 'deformation under load'.

Deflection within the allowable limits is a normal reaction and does not imply any danger regarding stability and safety. When your truss manufacturer does not supply any details on the allowable deflection limits, this can lead to a deceptive feeling of safety.

Prolyte provides two types of loading information. First, the allowable load without a deflection limit and secondly allowable load with a deflection limit of 1% of the length of the span ($L/100$). The loading tables in the catalogue contain the values without deflection limit.

In any case a deflection of less than 1% of the length of a truss span will be on the safe side when using Prolyte truss. Other truss manufacturers may use other deflection limits in their calculations.

However, if no details on deflection on a truss type are given, the load values should be viewed with caution. The user has no possibility to recognise the loading limit, or check excessive deflection.

The condition of truss connections can be a cause for truss deflection. Insufficient secured bolts, worn connection elements or deformed end plates all cause extra deflection within a truss span.

Prolyte's conical connection systems (CCS®) have been designed to compensate a certain amount of wear through their tapered design.

The height of a truss determines, to large extend, the stiffness of the truss. The greater the overall height of the truss (in the direction of force), the greater the stiffness and the smaller the deflection under the same load.

Prolyte adheres to the practice of including full deflection in the technical information and giving deflection as a limiting factor for the bearing capacity. Prolyte believes it makes no sense to publish load values that do not consider deflection.

The result is a feeling of insecurity for observers when they see a strongly deflected truss, even if the truss is within the limits of its bearing capacity.



ATTENTION

- Never exceed the maximum allowable deflection of a single span (see our loading tables) without consulting a qualified structural engineer.
- Loading tables only refer to single spans, the allowable deflection on a continuous span or in 2D or 3D structure can therefore not be found in the loading tables.

There are also applications where deflection must remain within certain limits. For example, when drapes are hung from a truss span, deflection will cause the drapes to sweep the floor in the middle, while being too short on the outer ends. If curtain or camera tracks are used, no deflection will be accepted, a completely level truss will be required.

Horizontal loads

Horizontal loads are often underestimated. They are caused by many factors, e.g. wind, tension forces created by canopies, drapes, screens, etc. The values given in the loading tables refer to loading of the truss in a vertical direction only. If a second bending force in horizontal direction is added, this can cause overloading of the truss even though the vertical load is within the limits of the loading tables. Due to their design the truss types H20V, S36R, S52F, S52V, S66R, S66V, S100F and all two-chord trusses in UP orientation may not be subjected to any horizontal loads without consulting a structural engineer.

1. TRUSS

If this cannot be avoided, these forces must be transferred, e.g. via other trusses for transferring compression forces or steel wires for transferring tension forces.

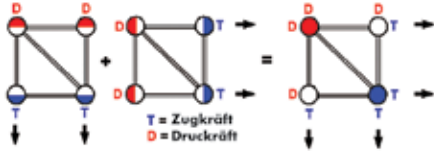

Effect of vertical and horizontal forces at the same time

The picture shows the effect of vertical and horizontal forces acting on a four-chord truss.

Dynamic forces

When lifting and lowering loads with electric chain hoists, the starting and stopping cause additional dynamic forces which must be taken into consideration when determining the overall load. When using standard hoists with a nominal lifting speed of 4m/min a factor of 1,4 is used to take account of the dynamic forces.

If higher speeds are expected, e.g. fast running chain hoists or winches, the loads and the bearing capability of the truss should be examined by a competent person.

1.2.3 Connection systems

The majority of truss modules are 2-3 metres long (6 to 10 feet). However, longer lengths are normally needed. The cost advantages of purchasing 5m modules are quickly lost in handling and transportation costs. For this reason a rapid, efficient and strong connection system is needed to connect the trusses. Although there are many types of truss connections, Prolite uses three types of connections today.

Pin / fork connection

The 'female' fork is connected to the 'male' pin via a cylindrical bolt. A very strong type of connection, also used in crane technology. The connecting bolts are exposed to shear forces.

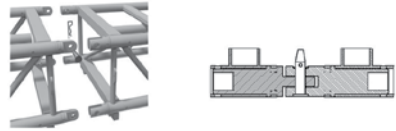

Advantages:

- Few individual parts.
- Very strong connection.
- Very quick and simple assembly.

Conical connection

Connection with a solid double conical connecting element which is secured with a conical spigot pin in the connectors welded to the ends of the main chords. The conical spigot pins are exposed to shear force.

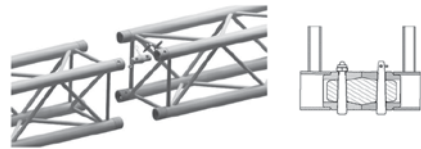

Advantages:

- Universal system.
- Exact alignment of elements.
- Very quick and simple assembly.
- Connection is 100% rigid.
- Installation length equals truss length.
- Compensation of wear in the drill holes using conical spigot pins.
- Connecting elements are not easily damaged and are easy to replace.



Verto connection

Latest type of connection developed by Prolyte. A grooved connecting element made from hardened steel is held in the connectors of the truss by steel balls which are pushed into the grooves of the connecting element by a special revolving steel nut. The revolving steel nut can be operated by hand and is fixed in the locked position by a safety clip.

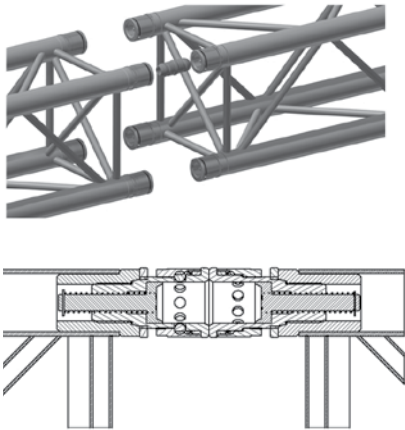

Advantages:

- No tools needed.
- Ultra fast assembly.
- Silent assembly.
- Connection is 100% rigid.
- Installation length equals truss length.

1.2.4 Types of load and static systems

Looking at the loading of trusses or truss structures we have to distinguish between distributed loads and point loads. Distributed loads can be uniformly along a truss span or a part of a truss span. Point loads can be applied symmetrically or unsymmetrically. In order to explain the different types of load we look at the simplest setup, a truss span supported at both ends.

Uniformly distributed load (UDL)

A load that is evenly applied along the length of a truss span. Examples of uniformly distributed loads are curtains, decorations, lighting fixtures of the same weight distributed at regular, very short distances along a truss span.

A uniformly distributed load per meter uses the symbol q and is given in kg/m or kN/m .



Centre Point load (CPL)

The centre point load is a single load that is applied at the centre of a truss span. The centre point load is the worst loading scenario for a truss span since the position of the load has the largest distance to the supports. If the centre point load is shifted into the direction of a support, it will no longer be a centre point load but just one point load, it will cause a lower bending moment in the truss span and the deflection of the truss will be less. The transverse force on the truss at the position of the point load will remain the same but the transverse force on the truss at the support which the point load is moved towards will be increased. Examples of point loads are single lighting fixtures, speaker cabinets and suspension points.

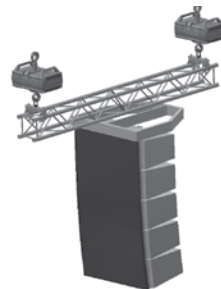

1. TRUSS

Multiple point loads

If more than one point load is present on a truss span it is named multiple point loads. If these multiple point loads are at the same distance to each other and to the supports we define them as:

- Third point loads (TPL): Two point loads applied to a truss span dividing it into thirds
- Quarter point loads (QPL): Three point loads applied to a truss span dividing it into quarters
- Fifth point loads (FPL): Four point loads applied to a truss span dividing it into fifth

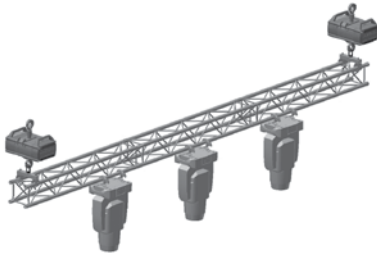

Partly distributed loads

A partly distributed load exists if only a part of a truss span is subject to a uniformly distributed load or when several point loads are mounted in a limited zone while the rest of the span remains free of loads.



The easiest way to estimate the safe bearing capability of a truss under partly distributed loads is to determine the total load and then to consider this load as a centre point load (worst type of load).

Non-uniform loads

The most common type of load is the non-uniform load. It occurs if different types of loads or a non-uniform distribution of point loads are present on a truss span. The safe bearing capability of a truss under non-uniform loads is to determine the total load and then to consider this load as a centre point load, same situation as the partial load case.

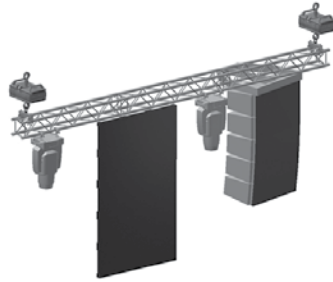

Rule of thumb:

Sum up all loads acting on a truss span and make sure the sum is less than the allowable CPL of that span.

End point load (EPL)

A truss that is only supported at one end is called a cantilever. A cantilever can be loaded with different load combinations but the worst load will always be a point load at the unsupported end of it. This load is called end point load. If the cantilever is loaded unsymmetrically, use the same principle as for non-uniform load to determine the safe bearing capacity.

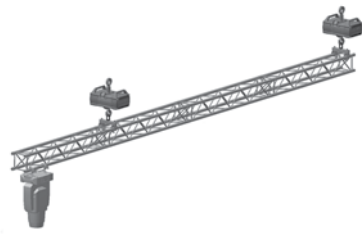



Static systems

The simplest static system is a single span truss supported at both ends. It is called a statically determinate system because the load itself and the loading of the two supports is easy to determine by simple calculation. The total load including the self-weight of the truss and other equipment involved will be transferred to the two supports. If all loads are symmetrically applied, each of the two supports will receive 50% of the total load. If the loads are applied unsymmetrically the support that is closer to the centre of gravity of the system will receive more than 50% of the total load while the other support will take less.

All loading tables are based on the system of a single span truss with both supports considered to be hinged (simply supported). Under load the hinged supports allow for vertical deflection of the truss between the two supports.

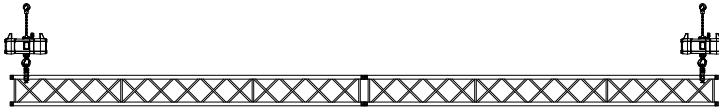

Single span truss hanging on two electric chain hoists (simply supported)

If the two supports would not be hinged but rigid restrained (fixed), the truss could take higher bending moments because the restraint would hinder the deflection of the truss. This situation is uncommon in the entertainment industry. Loading data based on this situation would provide much too high values and thereby create dangerous situations.

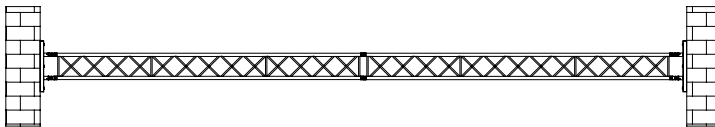

Single span truss rigidly restrained at both ends

In most situations in entertainment technology single span trusses have the supports placed inwards so that the ends of the truss project over the supports. These projections are also called cantilevers. These cantilevers can be loaded as well. The load on the truss span and the cantilevers and their self-weight have an influence on the transverse force in the truss at the position of the supports. The length and load of the cantilevers also influence the bending moment of the truss in the areas of the supports. Furthermore, cantilevers are only protected against torsion forces by the kind of support (e.g. Roundsling) they cantilever over and therefore are very susceptible to asymmetric load application. Load on cantilevers have an influence on the bending moment of the truss between the two supports. This phenomenon can be used to reduce the deflection of the truss between the supports but shall be carried out by experienced and competent persons only.

1. TRUSS

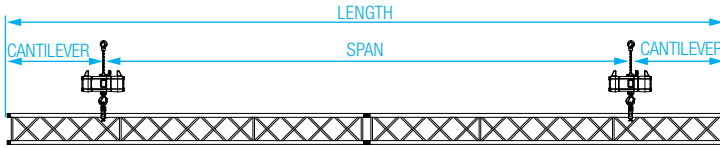

Single span truss with cantilevers. System length is span + 2 x cantilever

On the very safe side, one sixth of the span can be assumed as an allowable cantilever that can be loaded to the same amount of uniformly distributed load as in the main span. Please note that cantilevers can be much longer and take much more load than following this rule of thumb. Please refer to the technical data sheets of our truss series to find allowable cantilever loads and the necessary boundary conditions.

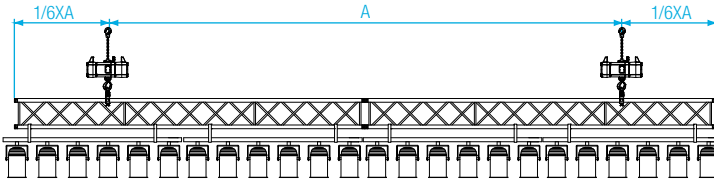

Single span truss with cantilevers loaded in UDL of truss span

Example:

Truss type: H30V

Length of span A: 12m

UDL at 12m: 83,2kg/m

Length of cantilever: $\frac{1}{6} \times A = \frac{1}{6} \times 12\text{m} = 12\text{m} / 6 = 2\text{m}$

Length of system: $A + 2 \times \frac{1}{6} \times A = 12\text{m} + 2 \times 2\text{m} = 16\text{m}$

UDL at system length: $16\text{m} \times 83,2\text{kg/m} = 1331,2\text{kg}$

UDL at cantilever: $2\text{m} \times 83,2\text{kg/m} = 166,4\text{kg}$

Rule of thumb:

One sixth of the span between the supports can be assumed as an allowable cantilever that can be loaded to the same amount of uniformly distributed load as in the main span.

If the required system length exceeds the allowable length of a truss as a single span or if the deflection of a single span exceeds an acceptable value, either a stronger truss is required (always recommended) or the number of supports has to be increased. As soon as the number of supports for a straight length of truss is increased to three or more, the system is called a multiple-span truss and becomes a statically indeterminate system.

Statically indeterminate systems are not easy to calculate. The load in one span, the area between two supports, has an influence on the behaviour of the neighbour spans. The possible load scenarios are inexhaustible. Multiple-span trusses have to be approached with a view to the load capacity of the truss and with a view to the load capacity of the supports. Regarding the load capacity of the supports we make use of the theoretical support reactions of ideal continuous beams under uniformly distributed load. In this ideal situation all supports are at the same distance and exactly at the same height. We find a tremendous shift of the support reactions compared to a single span truss.

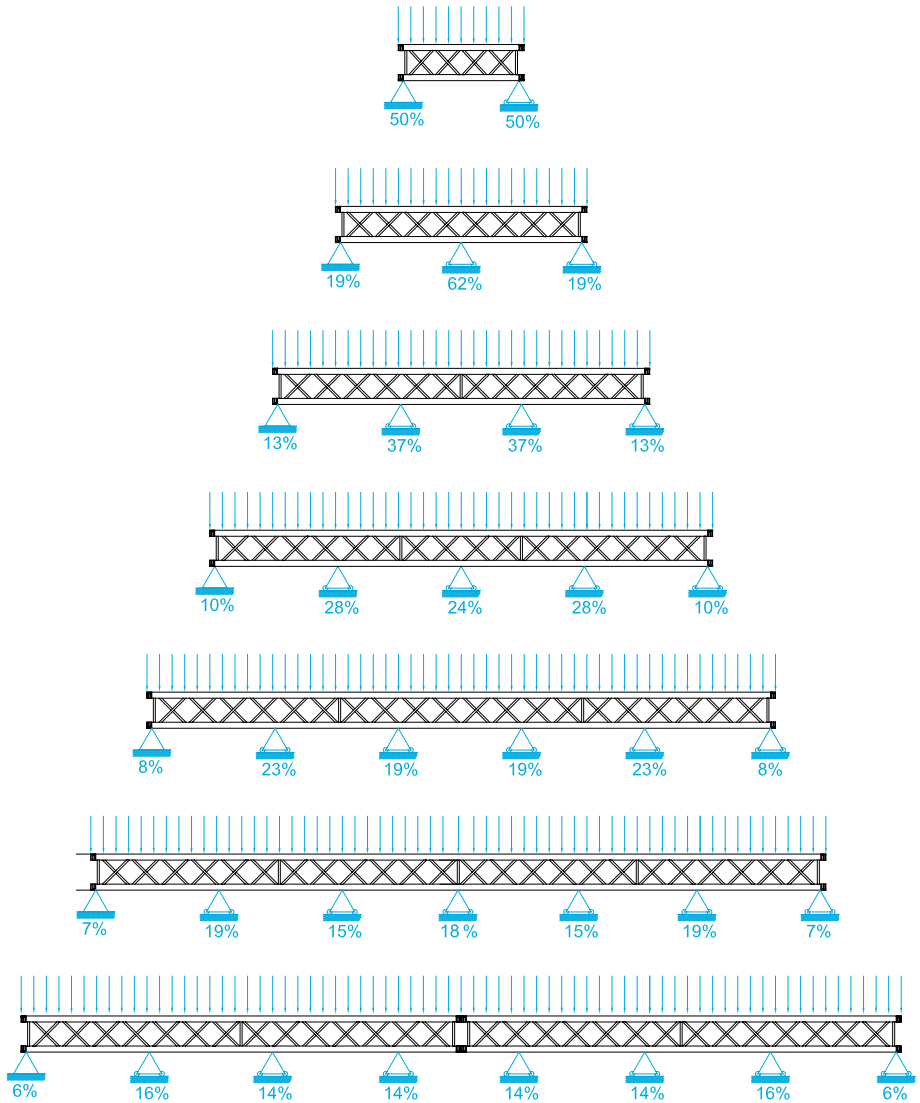

Distribution of support reactions of ideal continuous beams (multiple-span truss)

1. TRUSS



Photo: Space Roof, Interstage, Zwarte Cross Festival, Netherlands

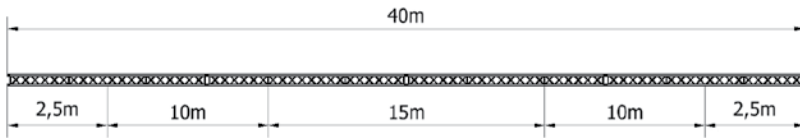

In practice we find tolerances in lifting accessories, imperfections of slinging methods and deviating hook heights of chain hoists that cause different heights of the supports. Depending on the stiffness of the truss, these height differences can cause individual support points to be free of load generating doubled truss span length between the neighbour supports and simultaneously increasing the load at these supports.

Regarding the load capacity of the truss in a multiple-span system the inexhaustible number of load scenarios make it impossible to generate suitable loading tables with maximum allowable load values. Multiple-span trusses demand for an individual structural assessment if it comes to the need for maximum loading.

On the safe side it is possible to determine if a truss type will be sufficient for a known load scenario even with different support distances. At first we determine the length of the longest support distance. Then we look at the possible UDL of a single span truss of this length and reduce the UDL by 50%. This value can be used as a UDL for the full multiple-span truss.

Example:

H40V, Length 40m, four support points, three-span-beam with cantilevers

Rule of thumb:

In order to determine the safe load capacity of a truss in a multiple-span system we determine the length of the longest support distance. Then we look at the possible UDL of a single span truss of this length and reduce the UDL by 50%. This value can be used as a UDL for the full multiple-span truss.

H40V, longest support distance 15m,
UDL = 74kg/m as single-span.
74kg/m -50% UDL allow = 37kg/m
Maximum UDL of the truss length:
40m x 37kg/m = 1480kg

Mind the support reactions and support heights! If one or more supports without load could cause other supports to be overloaded consider in using load control systems!



Please be aware that the compression and tension forces acting in the main chords are reversed at the inner supports of multiple-span trusses. This can be described with a negative bending at the inner support points of a multiple-span truss. While a deflection in a field between two supports will cause compression force in the top main chords and tension force in the bottom main chords, the main chords will be subject to tension force in the top main chords and compression force in the bottom main chords.

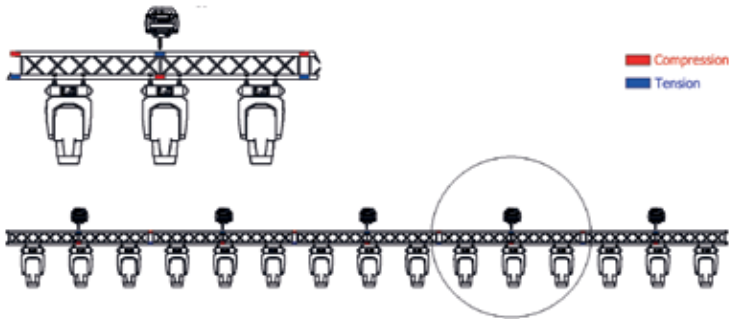

1.2.5 Loading tables for straight trusses

Prolyte loading tables for straight trusses provide information about the maximum allowable loading of a simply supported single span truss without cantilevers, the maximum length of the single span truss, the expected deflection and the average self-weight of the truss span. The loading tables are calculated for truss spans which are composed of any truss module lengths of the truss types. Hence there is no need to care about the positions of the connections of the truss modules in a truss span.

There is always the possibility to analyse if higher loading data will be possible when the positions of connections of the truss modules in a truss span are specified especially for short spans. Please get in touch with your Prolyte supplier if you are in need of higher loading data than given in the loading tables.

Loads are given in the units kilogram (kg) and pound (lbs), deflection is given in the units millimetre (mm) and inch (inch), length is given in metre (m) and foot (ft) all combined in a single loading table. It might be difficult to find the required data at first sight, therefore we will explain the structure of the loading table of the truss type H30V as an example¹. If loading data for an intermediate length is required, always use the data of the next larger length.

- | | |
|--|--|
| 1 Length of the truss span in metres | 50 Deflection in inches under CPL |
| 2 Length of the truss span in feet | 51 Allowable third point loads (TPL) in kg |
| 3 Allowable uniformly distributed load (UDL) in kg/m | 52 Allowable third point loads (TPL) in lbs |
| 4 Allowable uniformly distributed load (UDL) in lbs/ft | 53 Allowable quarter point loads (QPL) in kg |
| 5 Deflection in millimetres under UDL | 54 Allowable quarter point loads (QPL) in lbs |
| 6 Deflection in inches under UDL | 55 Allowable fifth point loads (FPL) in kg |
| 7 Allowable centre point load (CPL) in kg | 56 Allowable fifth point loads (FPL) in lbs |
| 8 Allowable centre point load (CPL) in lbs | 57 Average total self-weight of the truss span |
| 9 Deflection in millimetres under CPL | |

¹ the structure of the loading table of the truss type H30V

Example: A truss span of 9,5m length shall be regarded as a truss span of 10m length.

- Loading figures are only valid for static loads.
- Loading figures are only valid for single spans with supports at both ends.
- All static systems, other than single spans, need an individual structural calculation. Please contact a structural engineer or Prolyte for assistance.
- Loading figures are calculated according to and in full compliance with European standards (EN 17115 and Eurocode).
- The self-weight of the trusses is already taken into account.
- Loading figures are only valid for the cross sectional orientation of the truss as shown by the icon in the loading table.
- The interaction between bending moment and shear force at the connections of truss modules is already taken into account.
- Truss spans can be assembled from different truss lengths.
- Read the manual before assembling, using and loading the truss.

1.3 CORNER MODULES

If straight trusses are not sufficient to provide the desired load bearing solution, if the loading capacity of the ceiling or roof of a venue is too low, if scenery sets or decorations need to be reinforced or artistic demands need to be fulfilled, additional structural components will be required. The easiest solution for those structural components is the use of corner modules. They are defined as associated structural components intended to be used to connect truss modules in different directions.

1.3.1 Types of corners

Prolyte provides different types of corner modules. The most common corner module consists of two or more short truss sections welded to each other at different angles. The standard series start with a simple 2-way corner and end up in a star shaped 6-way corner. Prolyte developed a unique coding system to describe the different types of corner modules. While corners for square trusses are quite easy to understand, corners

for triangular truss become quite complex due to the different possible orientations of the triangular cross section of the truss. Please take a look at the Prolyte product brochures to get more information about the Prolyte corner module coding system.

After producing welded corners right from the start, Prolyte developed the revolutionary Boxcorner in the late 90ies of the last century. The Boxcorner combines accuracy, low tolerances, robustness and stability. This is realized by bolting the main chords to massive cubes in the corners of the box. Solely the diagonals are welded to the main chords of the Boxcorner. The Boxcorner has no permanently fixed connectors, different connecting elements can be bolted to the cubes in the corners of the box making the Boxcorner a versatile associated structural component.

The patented Verto truss system demanded for even lower tolerances than the standard Boxcorner. Prolyte developed the HD Boxcorner on the basic principle of the standard Boxcorner but without the need to weld any component of it. The HD Boxcorner is an all-bolted corner module with very low tolerances and extraordinary strength.

1.3.2 Stability and loading of corners

The determination of the allowable loading of corner modules is a complicated matter. The design and construction of a corner module has an influence on the allowable load the corner module can take. Just a few corner modules can absorb the load applied by the connected truss modules when these are under maximum load.

Furthermore not only the construction of the corner module is decisive for the allowable load on it, also its position in a two- or three-dimensional truss structure is crucial. Therefore the loading capacity of corner modules must be checked for each individual case, including the lengths and loads on the connected truss modules or truss spans.



H30V - Allowable Loading

SPAN	UDL		DEFLECTION		CPL		DEFLECTION		Centre Point Load		TPL		QPL		FPL		SPAN	total weight
	kg/m	lbs/ft	mm	inch	kg	lbs	mm	inch	kg	lbs	kg	lbs	kg	lbs	kg	lbs		
3	649.0	436.7	10	0.4	1667.9	3681.0	8	0.3	973.4	2148.4	649.0	1432.2	486.7	1074.2	18.9			
4	485.3	326.5	18	0.7	1298.1	2864.9	15	0.6	932.1	2057.2	647.1	1428.1	485.3	1071.1	25.2			
5	387.1	260.5	28	1.1	1074.2	2370.9	23	0.9	749.1	1653.3	581.1	1282.5	469.0	1035.1	31.5			
6	321.6	216.4	41	1.6	914.4	2018.2	33	1.3	644.7	1422.8	488.7	1078.6	389.3	859.3	37.8			
7	255.6	172.0	56	2.2	794.4	1753.2	45	1.8	564.8	1246.5	420.7	928.6	337.3	744.4	44.1			
8	194.4	130.8	73	2.9	700.6	1546.3	58	2.3	501.6	1107.0	368.5	813.3	296.9	655.2	50.4			
9	152.4	102.5	92	3.6	625.2	1379.9	74	2.9	450.2	993.7	327.0	721.8	264.5	583.8	56.7			
10	122.3	82.3	114	4.5	563.2	1242.9	91	3.6	407.6	899.5	293.2	647.1	238.0	525.2	63.0			
11	100.1	67.4	137	5.4	511.0	1127.8	110	4.3	371.5	820.0	265.1	585.0	215.7	476.1	69.3			
12	83.2	56.0	164	6.5	466.5	1029.6	131	5.2	340.6	751.7	241.2	532.3	196.8	434.3	75.6			
13	70.1	47.2	192	7.6	428.0	944.6	154	6.1	313.7	692.4	220.7	487.0	180.5	398.3	81.9			
14	59.6	40.1	223	8.8	394.3	870.2	178	7.0	290.1	640.2	202.8	447.5	166.2	366.8	88.2			
15	51.2	34.5	256	10.1	364.5	804.3	205	8.1	269.1	593.8	187.0	412.8	153.6	338.9	94.5			
16	44.3	29.8	291	11.5	337.8	745.5	233	9.2	250.3	552.3	173.0	381.9	142.3	314.1	100.8			
17	38.6	26.0	328	12.9	313.8	692.5	263	10.4	233.3	514.9	160.4	354.1	132.2	291.8	107.1			
18	33.8	22.8	368	14.5	292.0	644.5	295	11.6	217.9	480.8	149.1	329.0	123.1	271.6	113.4			
19	29.8	20.0	410	16.1	272.2	600.7	328	12.9	203.7	449.6	138.7	306.2	114.7	253.2	119.7			
20	26.3	17.7	454	17.9	253.9	560.4	364	14.3	190.7	420.9	129.3	285.3	107.1	236.3	126			

1 inch = 25.4 mm | 1m = 3.28 ft | 1 lbs = 0.453 kg

1. TRUSS

In three-dimensional truss structures, e.g. ground-support structures, also the height of the vertical trusses has an influence on the loading capacity of the corner modules.

For Example a three-way corner module in a simple ground support with four legs would need to transfer 50% of the load of two connected horizontal trusses (symmetrically loaded) into the vertical truss. The vertical truss would be under compression in combination with bending in two directions depending on the stiffness of the corner module and the height of the vertical truss. Keeping in mind that the truss modules can be freely combined and different dimensions of the ground support structure are likely to be build, in combination with reams of loading scenarios, it will be easy to understand that it is impossible to generate universal loading data of corner modules.

Looking at simple welded corner modules it is obvious that a corner cannot take more load than an undisturbed truss module. The ends of the main chords of welded corners are welded to each other at different angles and different contact areas. Internal forces generated by the load on connected truss modules need to be transferred through the connection of the main chords and through the diagonal members of the welded corners depending on the design of the corner. In many cases the diagonal members of a corner are the limiting elements.

As a general rule, truss spans attached to welded corners shall not be loaded with more than 40% of the CPL of the truss span as given in the loading tables for single span trusses. Following the rule of thumb for non-uniform loads on single span trusses, 40% of the CPL of the truss span sets the limit for all loads attached to the span between two corner modules. Often higher loads are possible, but that shall always be verified by structural calculation carried out by qualified and competent persons.

Using standard Boxcorners in the same structure as described above will make the structure much stronger. The horizontal trusses that are connected to the Boxcorners can be loaded up to 70% of the



Photo: NeuroTech project in China



allowable CPL as given in the loading tables for the truss types. As soon as additional structural extensions like cantilevers or circle modules are incorporated, it is strongly advised to carry out structural calculation by qualified and competent persons.

Detail explanation on corner modules:

Prolyte made a scientific investigation on standard welded corner modules. Main problem with standard welded corner modules is the load transfer from a horizontal truss span into vertical legs. The load transfer from horizontal to vertical is mainly taken care of by the last diagonal member, with a design resistance buckling value of 10,42kN.

Practical test of a H30V-C003 shown a maximum load of 120kg at a cantilever of 3m H30V, which result in a 3,6kNm Mrd bending moment. At 120kg load there is the transition from elastic to plastic deformation. With the partial safety factors of the Eurocode taken into account, this results in a allowable cantilever point load of 80kg at 3m H30V.

This has been checked in theoretic as well:

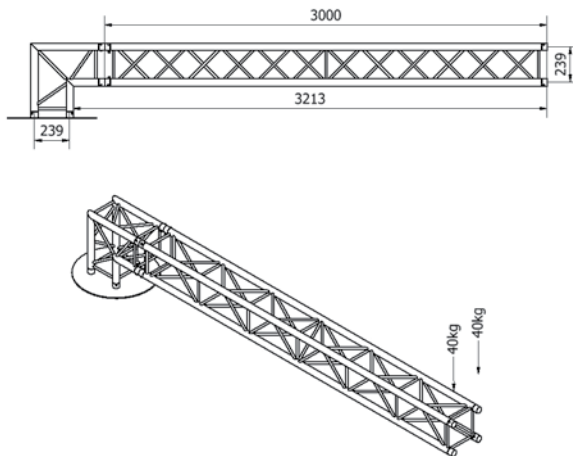

Stresses total: $11.31\text{kN/cm}^2 < 11.36\text{kN/cm}^2 = \text{okay}$

Resulting in Theory = Practice = okay.

The allowable loading of a H30V-C003 and a BOX-30V compared with H30V can be written as:
Design resistance Bending moment Mrd H30V: 24kNm

Design resistance Bending moment H30V-C003:
 $1,2\text{kN} / 1,1 \times 3\text{m} = 3,3\text{kNm} \rightarrow 3,3 / 24 =$
14% of a H30V truss

Design resistance Bending moment BOX-30V:
 $3,35\text{kN} / 1,1 \times 3\text{m} = 9,13\text{kNm} - 9,13 / 24 =$
38% of a H30V truss

The next step is to evaluate the corner modules at ground supports. In which the length of the spans and the legs also is important. Depending on the leg length, the corner module can be considered as acting semi-hinged. With a characteristic transition of 1kNm bending moment.

Checking the following span length of 3,6,9,12,15m H30V with a 40% of the max CPL. Results in a small overloading of 5% at material stresses in the lower diagonal member of the corner module.

This check has also been performed on a leg support of 100% hinged and 100% restrained (support of the corner module depends on the leg length and constraint of the leg base).

Summarizing the loading capacity of a corner module strongly depends on the design of the corner (main chords and diagonal members) and load transition in the corner module itself.

If a corner module is subject to load transition from a horizontal span into a vertical leg, load transition is depend on a welded diagonal member. And so the loading capacity of the corner module.

In general it is advised to reduce allowable CPL loading of a span with 60% if the span is used in conjunction with corner modules where load transition goes from horizontal to vertical.

If corner modules are used where load transition goes from horizontal to horizontal, 100% of the allowable loading a truss span can be transferred by the corner module. The same evaluation has been made for 30V Boxcorner elements.

For a 30V Boxcorner it is advised to reduce allowable CPL loading of a span with 30% if the span is used in conjunction with corner modules where load transition goes from horizontal to vertical.

If Boxcorners are used where load transition goes from horizontal to horizontal, 100% of the allowable loading a truss span can be transferred by the Boxcorner.

1.4 CIRCULAR TRUSS

Prolyte is known for its full range of truss series for the widest range of applications. In addition, Prolyte manufactures trusses in circular form, arcs and ellipses. Prolyte manufactures these curved trusses with an especially high level of precision to ensure good fitting accuracy without distortion.

All circular trusses are manufactured in a specialised department within the factory. This department is equipped with state-of-the-art welding jigs that are designed in-house.

This welding jigs allows all circular segments to be manufactured as standard elements, from the decorative E-series truss to the robust S-series. This ensures that each curved segment can be inserted at any position in a circle without impacting the overall shape of the circle. Circular trusses and arcs can be made with any truss series up to the S-series, except for S36PR and S52F.

Although Prolyte has raised the production of circular trusses to the same standard as straight trusses, there is still a big difference that needs to be known. The production of curved trusses requires considerably more time. Each individual chord tube needs to be rolled to a specific radius in order to function as a chord tube of a circular truss. This means that a curved truss has at least two different radii: the inner chord and the outer chord radius. Each tube can only be rolled over a limited length by the rollers of the bending machine. The loss during bending is approximately 50cm at each tube end. This means that a semi-finished product length of 6 m has a maximum curved length of 5m. This is the segment length for curved trusses that form a circle.

There is a lower limit for the bending radius for each type of tube. If the radius is made smaller, the chord tube assumes an oval shape (10% deformation is the maximum limit) and it loses its shiny surface due to the strong compressive forces on the inner edge. The degree to which a tube can be rolled with satisfactory results depends on 3 factors:



Photo:AC Lighting, Canada

- Outer diameter of the tube; this has a direct influence on the geometrical moment of inertia and the resistance to bending.
- Wall thickness of the tube; this also has a direct influence on the geometrical moment of inertia and the resistance against bending, with thicker walls being less susceptible to surface changes but requiring considerably more energy and time to bend.
- Composition of the tube; the lower the rigidity, the easier the cold forming process is.

Prolyte gives the values of the circular truss dimensions as the outer radius of the outer chord tube. The inner radius of the inner chord tube limits the bending process. The values given are minimum circle dimensions which ensure that the tube surface and the stability do not deteriorate greatly.

1.4.1 Circle segments

The clever selection of the number of circle segments that form a full circle is crucial.

For permanent installations the lowest number of circle segments seems to be the best economic choice at first sight, but it should be paid attention to high costs of transport and the possibility to get large circle segment to the place where the circle shall be installed.

For temporary installations and rental business we recommend a division into steps of four circle segments (4, 8, 12, 16, ...). With this division circles can be used in different setups as shown in the following figures. The number of segments of a circle depends on the radius of the circle. The maximum tube length that can be bent is 5m, which means that circular segments cannot be longer. Average lengths of circle segments between 2m and 4m are the easiest to handle, transport and store.

Furthermore, for three-chord circular truss the orientation of the triangle (apex up, apex outside or apex inside) and for two-chord circular truss the position of the two chords (flat or up) needs to be defined.

1. TRUSS

Examples to calculate the length of a circle segment:

	Truss type H30V	Truss type H40V
	Outer diameter 5m = radius 250cm	Outer diameter 15m = radius 750cm
Number of circle segments	4	16
Catalogue Number	H30V-R250-4	H40V-R750-16
Outer circumference:	$C = d \times \pi = 5\text{m} \times 3,14 = 15,7\text{m}$	$C = d \times \pi = 15\text{m} \times 3,14 = 47,12\text{m}$
Length of circle segment	$C / 4 = 15,7\text{m} / 4 = 3,925\text{m}$	$C / 16 = 15,7\text{m} / 16 = 2,945\text{m}$
Angle of circle segment	$\alpha = 360^\circ / \text{number of circle segments} = 360^\circ / 4 = 90^\circ$	$\alpha = 360^\circ / \text{number of circle segments} = 360^\circ / 16 = 22,5^\circ$
Transport length	$c = d \times \sin(\alpha/2) = 5\text{m} \times \sin 45^\circ = 3,54\text{m}$	$c = d \times \sin(\alpha/2) = 15\text{m} \times \sin 11,25^\circ = 2,93\text{m}$
Result	Length of circle segment is possible but might be difficult to handle.	Length of circle segment is okay.

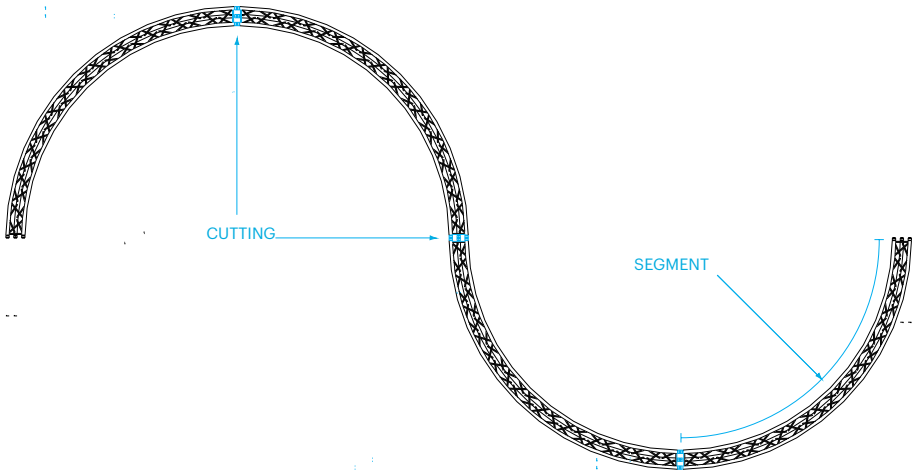



1.4.2 Loading of circles

Circular trusses in a horizontal orientation can absorb less load than straight trusses. In a circle segment the angles of the diagonal members to the main chords in the vertical plane for the inner and outer side of the segment is different. This causes an asymmetrical distribution of the transverse forces in circle segments. The different angles of the diagonal members usually cause longer distances between the node points of the lattice structure on the outer side of the circle segment which leads to a lower load bearing capacity of the outer main chords. Between two support points of a circular truss a cantilever area is created. The size of the cantilever areas of a circular truss depends on the diameter of the circular truss and the number of support points. The more support points, the shorter the cantilever.

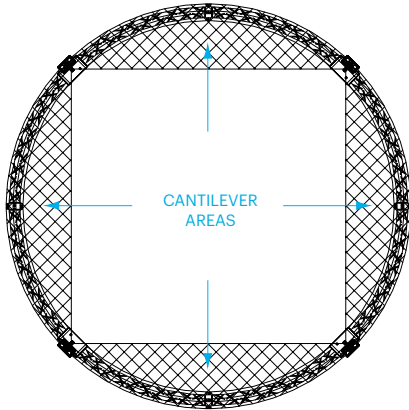

Applying loads to the circle segment causes deflection of the segment and this causes torsion forces in the truss which affects the bearing capacity of the circular truss. Please keep in mind that the ideal number of suspensions for two-dimensional structures like circular truss is three. Of course large circular trusses will need more suspension, but be aware that not all suspension could be under load, especially when the circular truss is lifted or lowered by means of chain hoists or winches.

Here is an example of a loading table of a H30V circular truss:

Diameter		3 Suspension Points		4 Suspension Points		6 Suspension Points		8 Suspension Points		10 Suspension Points	
		UDL	CPL	UDL	CPL	UDL	CPL	UDL	CPL	UDL	CPL
m	ft	kg/m	lbs/ft	kg/m	lbs/ft	kg/m	lbs/ft	kg/m	lbs/ft	kg/m	lbs/ft
4	13.1	188	126,3	305	205,2	547	368,4	786	528,8	1019	685,7
		575	1268,3	757	1671,9	1001	2209,5	1133	2502,1	1209	2668,1
6	19.7	102	68,4	175	118,0	336	226,3	498	335,1	656	441,7
		443	977,6	617	1361,3	880	1942,3	1041	2298,3	1139	2514,8
8	26.2	63	42,7	115	77,5	233	157,1	356	239,3	476	320,4
		359	793,3	519	1146,1	784	1731,5	962	2124,4	1077	2377,5
10	32.8	43	28,8	81	54,8	174	116,8	271	182,6	369	248,0
		302	665,9	448	988,2	707	1560,9	894	1974,3	1021	2254,0
12	39.4	30	20,5	60	40,7	135	90,8	216	145,4	297	200,2
		259	572,6	393	867,4	643	1419,9	835	1843,3	970	2142,3
14	45.9	22	15,1	46	31,3	108	72,8	177	119,2	247	166,3
		227	501,3	350	772,0	590	1301,6	783	1728,0	924	2040,7



Photo: Metro Productions, Homegrown Festival, New Zealand

All loading data is based on a horizontal suspension of a circular truss with evenly distributed suspension points and applied loads in each of the fields. In all other cases, this loading data is NOT valid. If high loads are unevenly distributed, instability can occur. If loading data for an intermediate diameter is required, always use the data of the next larger diameter.

Example

A circular truss with a diameter of 5m shall be regarded as a circular truss with a diameter of 6m. Suspended from three points it could be loaded with an UDL of 102kg/m. The circumference of the circular truss with a diameter of 5m is $C = 5m \times \pi = 5m \times 3,14 = 15,7m$.

The total allowable UDL for this situation is $Q = C \times \text{UDL} = 15,7m \times 102kg/m = 1601,4kg$! If the load is not UDL but somehow non-uniform and each of the three fields is loaded, the rule of thumb for non-uniform loads can be applied by looking at the allowable centre point loads (CPL) per field. In this case it would mean that three point loads of 443kg are possible.

The total allowable load for non-uniform loading would be $3 \times 443kg = 1329kg$.

If the circular truss would be suspended from 6 points, the total allowable UDL would be $Q = 15,7m \times 336kg/m = 5275,2kg$! The total allowable load for non-uniform loading would be $6 \times 880kg = 5280kg$! Always make sure that the suspension points and the lifting devices have sufficient capacity!

Please have a look in Prolyte's product brochure to get information about loading data of other circular truss types.

1.5 VERTICAL TRUSSES

Our technical department is frequently asked for loading tables for trusses used as towers.

In such applications buckling can easily lead to failure before reaching the allowable compression forces (normal forces). A truss tower under compression tends to deflect laterally (sideways).



Relevant factors in this type of use are:

- The height of the tower.
- The cross section of the tower.
- Restraint of the tower at both ends (top/bottom).

The theory of determining the maximal axial load that a long slender (ideal) column can resist without buckling is based on the four Eulerian buckling modes, derived by the swiss mathematician Leonhard Euler in the mid 18th century.

When using vertical trusses in the Entertainment Industry we are generally facing situations that are similar to the Euler Modes 1 and 2:

1. Fixed at the bottom, free at the top.
(This is similar to a cantilever situation)
2. Pinned (hinged) at both ends.
(tower or leg in a ground support structure)

Following the theory of Mr. Euler the buckling length s_k of a tower is calculated by multiplying the tower height A by a buckling length coefficient β .

The Euler Modes are theoretical models, a truss differs from an ideal column and the fixations provided by truss corner modules, tower sleeve modules, tower base sections or baseplates do not provide a 100% rigid restraint. Partly restraint fixations have to be considered. This is realized through buckling length coefficient greater than $\beta = 2$. Buckling length coefficients higher than $\beta = 2$ have to be determined (estimated) by structural engineers.

Please keep in mind that many other factors are relevant when calculating the risk of buckling of a vertical truss. It is not possible to give the allowable load values when only the height and the type of truss of the tower is known, therefore a simple table that pays respect to all relevant factors is impossible. The examples given in the following section are all theoretical and only explain how different systems affect the allowable loading. It is assumed that only vertical loading is present, no horizontal loading through wind forces etc., indoor use only.

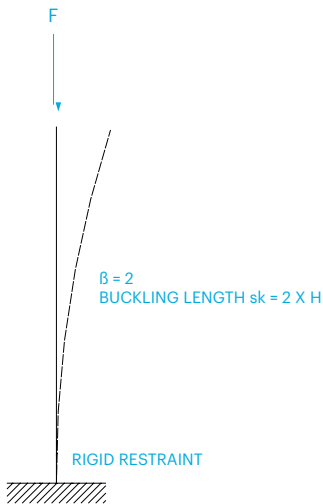

EULER 1E

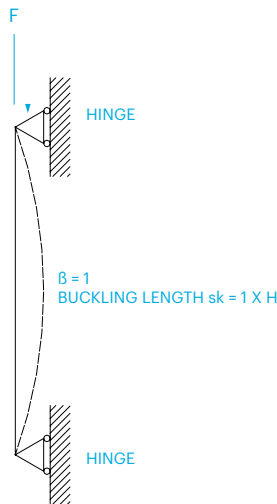

EULER 2E

1. TRUSS

EXAMPLE 1

Free-standing H30V Tower based on a tower base section, a steel base plate or a truss base structure, free at the top.

This example is similar to Euler buckling mode 1.

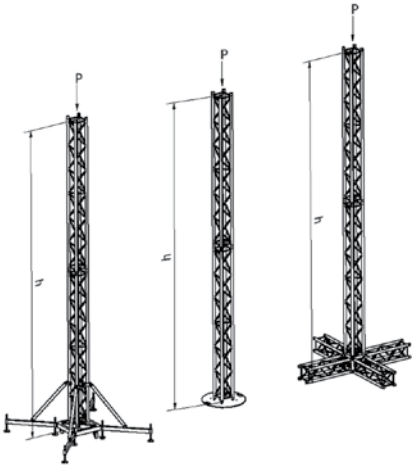

Free-standing H30V tower based on a tower base section, a steel base plate or a truss base structure, free at the top

The buckling length coefficient is estimated to be $\beta = 2,5$
Tower height A: 6,0m
Buckling length $sk = 2,5 \times 6m = 15m$

Following the design principles of Eurocode 9, Chapter 6, we find formulas which result in an allowable loading of $P = 1870kg$.

EXAMPLE 2

Free-standing H30V Tower fixed on a rigid concrete block, 100% rigidity, free at the top.

This example is equal to Euler buckling mode 1.

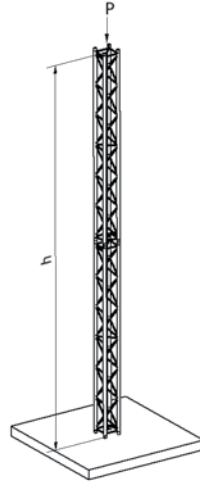

Free-standing H30V Tower fixed on a rigid concrete block, 100% rigidity, free at the top.

The buckling length coefficient is $\beta = 2$
Tower height A: 6,0m
Buckling length $sk = 2 \times 6m = 12m$

Following the design principles of Eurocode 9, Chapter 6, we find formulas which result in an allowable loading of $P = 2840kg$.

Please keep in mind that the examples are theoretical. In daily practice there will be load on the horizontal trusses, which results in bending forces on the towers, depending on the stiffness of the corners. Moreover you will have to consider horizontal loads on the whole structure.



EXAMPLE 3

H30V goalpost structure as a frame, towers hinged at the bottom and partly restraint at the top, e.g. through boxcorners.

This example is similar to Euler buckling mode 2.

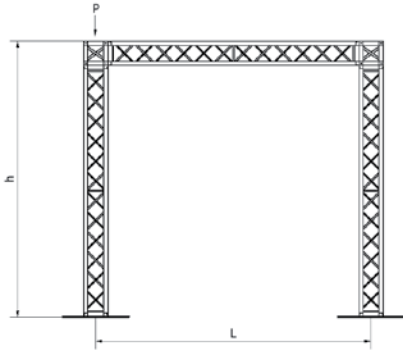

H30V goalpost structure as a frame, towers hinged at the bottom and partly restraint at the top, e.g. through boxcorners.

The frame is able to sway horizontally. The buckling length coefficient depends on the stiffness-ratio of the towertruss and the horizontal truss (both H30V). Buckling length coefficients of $2 < \beta < 3,5$ are possible.

It is assumed that $l = h$, this leads to a buckling length coefficient $\beta = 2,3$. In case of $l = 2 \times h$ the β -factor has to be increased to $\beta = 2,64$.

Tower height A: 6,0m
Buckling length $sk = 2,3 \times 6m = 13,8m$

Following the design principles of Eurocode 9, Chapter 6, we find formulas which result in an allowable loading of $P = 2190kg$.

EXAMPLE 4

H30V truss tower with a hinged connection at the top and at the bottom, either guy-wired in four directions or as part of a four-tower ground support with guy-wire crosses in all sides.

This example is equal to Euler buckling mode 2.

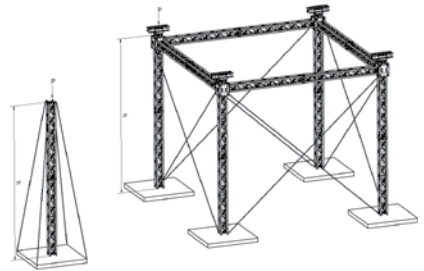

H30V truss tower with a hinged connection at the top and at the bottom, either guy-wired in four directions or as part of a four-tower ground support with guy-wire crosses in all sides.

Guy-wires tensioned, no horizontal sway is possible.

The buckling length coefficient is $\beta = 1$
Tower height A: 6,0m
Buckling length $sk = 1 \times 6m = 6m$

Following the design principles of Eurocode 9, Chapter 6, we find formulas which result in an allowable loading of $P = 8550kg$.

Conclusion: A tower build from H30V with a height of 6m gives four different outcomes in the allowable loading, depending on the system or structure it is part of.

Prolyte strongly recommends that tower load calculations shall be carried out by qualified and competent engineers.

In every case the stability against overturning needs to be guaranteed. Structural calculation carried out by qualified and competent persons is always highly recommended if it comes to heavy loading of structures or stability of a structure is not apparent.

1.6 TRUSS STRUCTURES

Truss modules are designed in such a way they can be connected to each other in several setups and layouts. When combining several straight trusses with each other or even straight trusses with corner modules and/or circular truss, so called truss structures are created.

To determine the strength, stiffness and stability characterises of a truss structure, the following differences have to be distinguished:

- Truss module
- Two-dimensional structures (like a simply supported span or a continuous beam)
- Three-dimensional structures (like a ground support structure)

For all Prolyte truss modules structural calculations are made, which determines the structural specifications of the truss module it selves (so-called design internal forces).

It is very rare that truss modules are used as single structural element. Creating truss structures always demands for evaluation on structural integrity by a competent person.

1.6.1 Two-dimensional structures

For two-dimensional truss structures as a simply supported span (truss structure made out of several straight trusses, supported at both ends) vertical loading specifications are given in the allowable loading tables. As already stated earlier, continuous beams cannot be determined with the allowable loading tables and shall be evaluate by a competent person.

1.6.2 Three-dimensional structures

Three-dimensional structures can be a ground supported structure (straight truss modules combined with corner modules), but as well flown structures with any type of corner module.

For any three-dimensional truss structure, a competent person shall evaluate the structural integrity of the structure for its applicable loads. As well check the support reaction coming from the truss structure.

1.6.3 Support reactions

Any truss structure is supported, this can be supported from the ground (for example by means of vertical truss modules or tower systems) or supported by means of lifting equipment or machinery. The reaction forces coming from the truss structure into its support, are the so-called support reactions.

Any type support of a truss structure shall be able to withstand the occurring reaction forces. A competent person shall determine the capacity of the support and evaluate the occurring reaction forces.

For simply supported spans, support reaction forces can be determined by the ratio of the distance of a loading towards the opposite support point and the total length of the span.

For example a 10m truss span, supported at both ends and a CPL of 500kg (F) (neglecting the self-weight of the truss structure and the support equipment), creates a $5m/10m \times 500kg = 250kg$ support reaction forces per support point.

With the same truss structure and a point load at 3m of the left support, the following support reaction forces occurs:

Left support is called support reaction point A, right support is called support reaction point B. The total length of the span is called L.



For support point A, the ratio of the loading depends on the distance from the loading towards support point B (distance A = DA). For support point B, the ratio of the loading depends on the distance from the loading towards support point A (distance B = DB).

For the example above DA = 10m – 3m = 7m, DB = 10m – 7m = 3m.

In other words the support reaction force in A can be calculated with:

$$(DA / L) \times F = (7m / 10m) \times 500kg = 350kg$$

The support reaction force in B can be calculated with:

$$(DB / L) \times F = (3m / 10m) \times 500kg = 150kg$$

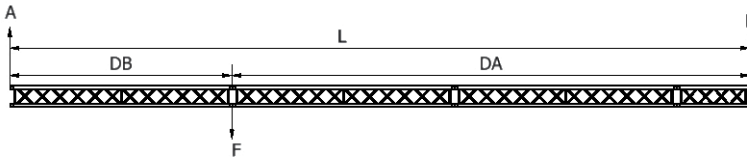

For simply supported spans with multiple point loads, support reaction forces can be determined by the ratio of the distance of a loading towards the opposite support point and the total length of the span.

For example a 10m truss span, supported at both ends, with a point load P1 of 300kg at 2,5m of the left support and a point load P2 of 450kg at 6m of the left support (still neglecting the self-weight of the truss structure and the support equipment), the following support reaction forces occurs:

Left support is called support reaction point A, right support is called support reaction point B. The total length of the span is called L.

For support point A, the ratio of the loading depends on the distance of load P1 towards the opposite support point B (distance P1 = D1) and the distance of load P2 towards the opposite support point B (distance P2 = D2) .

For the example above D1 = 10m – 2,5m = 7,5m and D2 = 10m – 6m = 4m.

In other words the support reaction force in A can be calculated with:

$$((P1 \times D1) + (P2 \times D2)) / L = ((300kg \times 7,5m) + (450kg \times 4m)) / 10m = 405kg$$

For support point B, the support reaction depends on the total loading of the span minus the support load in support A.

The support reaction force in B can be calculated with:

$$(P1 + P2) - A = (300kg + 450kg) - 405kg = 345kg$$

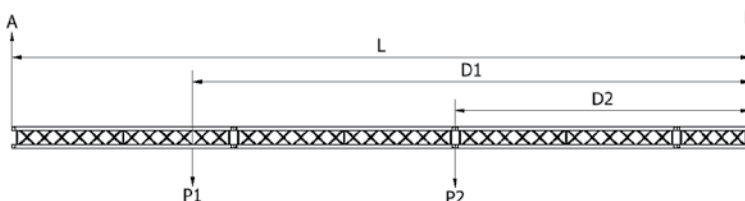

Support reaction forces from continuous beam structures shall be determined a competent person, as loading from one side of the support, effects the other side of the support. It shall be noticed that load shifts can easily occur while for example lifting a continuous beam structure by means of lifting machinery.

The shorter the span distances in between the supports of a continuous beam, the easier load shifts can occur. For example lifting a truss span on four electric chain hoists (from left to right motor A,B,C,D). And two hoists (B and D) are $\frac{1}{4}$ of chain link lower. Then it can occur that the complete truss is only support from hoist A and C. Which may result in an overloaded support and even an overloaded truss structure.

It is therefore strongly recommended to lift heavy loaded continuous beams structures with a load measurement system.

It is obvious that support reaction forces at three-dimensional truss structures shall be determined with the loadings which can be directed in worst case scenario from six directions. Special care should be taken with building truss structures at a subsoil, for example ground supported structures. The subsoil shall have sufficient allowable bearing pressure to withstand the occurring support reaction forces coming from the truss structure. In which a distinction shall be made in between bearing pressure and concentrated loads.

Allowable floor loading or bearing pressure is generally be given as a loading per square meter, for example 500kg/m². But support reaction forces of a truss structure are mainly concentrated loads (loading at a small area/surface – for example coming from a base plate or spindle), which shall be compared with permissible soil pressure. If the permissible soil pressure of a subsoil is not sufficient for the support reaction of a truss structure, distributing of the concentrated load of the truss structure can be done by using load spreaders, like wood pads or spreader bars. These elements spread the concentrated load at a wider area.

1.6.4 Stability

In a situation where a truss structure is subject to horizontal forces, lateral forces or imperfection, stability of the truss structure shall be evaluated. Also truss structures on sloping or uneven subsoil require an evaluation on stability.

Instability is not only a problem with three-dimensional structures, but can also be a problem with two-dimensional structures. For example by asymmetrical loading of the truss spans, where a LED wall or lighting fixtures are only supported from one bottom main chord of a square truss.

For three-dimensional structures, stability shall be checked on uplifting, overturning and sliding. Overturning of a truss structure may also occur by a cantilever load. In every case the stability against overturning needs to be guaranteed. Structural calculation carried out by qualified and competent persons is always highly recommended if it comes to truss structures in which stability is not apparent.

1.7 USE OF TRUSS

Information about the safe use of truss and helpful advices for daily practice

1.7.1 Planning and selection

In the phase of planning an event where trusses shall be used, one of the first actions is to determine load assumptions and to select the appropriate trusses with regard to load bearing capacity, stability and efficiency. The selection can be based on a check list. A risk assessment for the subsections of truss and rigging for an event shall be self-evident. One of the results of the risk assessment should be the need of structural calculation, use of load cells, etc.

1.7.2 Assembly

The assembly of Prolyte truss is widely self-explanatory (intuitive). Prolyte always followed the principle of foolproof assembly but practice has shown that people always will find creative ways to interpret the principles their own way. Irrespective of the easiness of the assembly of Prolyte truss, products placed on the market need to fulfil legislative requirements. One of these requirements



is the supply of user documentation by means of user manuals containing information about the assembly of the product.

Helpful tips might not be part of a user manual, so here are a few tips for the safe and efficient assembly of Prolyte truss:

- Always use a copper hammer for hammering on the conical pins. Copper has a similar self-weight than steel but is much more ductile. This protects the zinc plated surface of the conical pins and if the user misses the head of the conical pin and hits the connector or main chord the damage is much less.
- When assembling the Prolyte 20er to 40er trusses put wooden slats, truss carriers or something similar on the ground first and put the truss upon it in order to protect the truss from rough surfaces, get access to the connectors in the bottom main chords to insert the conical pins and to create enough space to apply lifting accessories like Softsteels or round slings.

1.7.3 Slinging of truss

When trusses need to be attached to lifting machinery, directly to rigging points or if loads need to be suspended from trusses, it is commonly realized by using flexible lifting accessories like polyester round slings, steel wire filled round slings or steel wires in combination with shackles. The load bearing capacity of these lifting accessories is called working load limit (WLL). The WLL is a fraction of the breaking strength of the lifting accessory. The proportion between breaking strength and working load limit gives the safety factor of the lifting accessory. If loads need to be suspended or even moved above people, generally these safety factors need to be doubled.

Alternatives to slings are non-flexible lifting accessories like hanging clamps or lifting brackets. Although the use of non-flexible lifting accessories cannot be considered as slinging, we will have a look at them at the end of this chapter.

1.7.4 slinging devices

Round slings

When handling aluminium tubes, soft and non-abrasive slinging devices shall be used. Polyester round slings would be the perfect choice. Unfortunately polyester loses its full load bearing capacity at temperatures above 100°C. Most countries have fire protection regulations that prohibit the use of polyester round slings near sources of heat. Accidents have occurred which were by melted round slings. If polyester round slings are used, a second non-flammable safety device - also known as secondary suspension - made of a steel wire or chain must be added.

Round slings with steel wire core (Soft Steel®)

The flexible slinging device Soft Steel differs from conventional round slings with its non-flammable steel wire core. Soft Steel is almost flexible as polyester round slings, but does not require steel wire as a second safety device due to its high resistance to heat. The polyester hose of the Soft Steel is black, the identification label is silver-grey and an inspection window covered with a Velcro strap means the steel wire core can be inspected. For the main chord of a truss, Soft Steel should be the preferred device.

Steel wires

A further flexible slinging device is a steel wire rope with eyes at both ends. Direct contact between the steel wire rope and the truss main chords should be avoided because of the abrasive surface of the steel wire rope. In this case plastic steel wire covers should be used. In countries where fixed plastic covers on steel wires are prohibited, sliding protective sleeves on the steel wires are used in order to carry out visual inspection of the steel wire.

Steel wires are more difficult to use in slinging methods because of their lower flexibility in comparison so Soft Steels. Prolyte does not recommend to use steel wires to sling aluminium trusses.

Steel chains

A further flexible slinging device is a steel chain with hooks or master links at both ends. Direct contact between the steel chain links and the truss main chords shall always be avoided. Prolyte does not recommend to use steel chains to sling aluminium trusses.

Slinging Methods

The innumerable variants of slinging methods that can be seen around the planet are all based on four basic slinging methods. These are:

Direct

Direct is used as a part of a bridle or to extend the length of a sling when suspending loads in combination with shackles or hooks.

Basket

A basket is done with a single sling that forms a loop around the truss or one or two main chords of the truss. The loop is closed by means of a shackle. The working load limit (WLL) of the sling will be doubled (sling factor 2) as long as the two sling ends are at very small angles $\alpha < 14^\circ$ to each other. The angle between the ends of the slinging devices cause a reduction of the doubled WLL. At angles of $14^\circ < \alpha \leq 90^\circ$ the reduction will be 30% (factor 0,7) and at angles of $90^\circ < \alpha \leq 120^\circ$ the additional reduction will be 50% (factor 0,5). As a general rule the angle shall not be greater than 120° .

Choke

A choke is done with a noose that pulls tight under load at one end of a single sling. When slinging truss this type of slinging should only be used with two identical flexible slinging devices each on one side of the truss.

Each slinging device is tied around a main chord at one end and the other ends meet each other in a shackle. Steel wires are unsuitable for this method when slinging aluminium truss. A choke reduces the working load limit (WLL) of a sling by 20% (factor 0,8). The angle between the ends of the two slings cause an additional reduction of the WLL. At angles of $14^\circ < \alpha \leq 90^\circ$ the additional reduction will be 30% (factor 0,7) and at angles of $90^\circ < \alpha \leq 120^\circ$ the additional reduction will be 50%.

Wrap

This method is basically used in connection with a choke or a basket and is primarily used to include one of the upper main chords of a truss. Furthermore it is used for horizontal stabilisation of a truss, to prevent a truss from rotating around its centre line, to provide a large contact between the sling and the main chord or to shorten the working length of a sling. The WLL of the sling is not reduced if the wrap is performed cleanly. A wrap is never used on its own, it will always be in combination with a basket or a choke.

Sling hitches

The combination of the slinging methods results in a so-called sling hitch. The combinations are limited to the combinations basket with or without wrap(s) or choke with or without wrap(s) but the ways of laying the slings around or through the cross section of a truss are endless and can lead to shoreless discussions and debates. In previous editions of the Prolyte Black Book we have presented different sling hitches for our trusses. These had been based on experience and advice of internal and external experts. Meanwhile we have gathered more and more knowledge about slinging trusses and we would like to provide this knowledge in the following.

In theory, slinging shall be applied in the node points of the truss. This is often not possible due to the small space between two diagonals that meet the main chord in a node point. The slings could pile up in the node point between the two diagonals when choking or wrapping and provide local pressure on the diagonals. Therefore Prolyte has verified that a distance of up to 10cm out of the node point can be regarded as in the node point. It shall be avoided to apply heavy loads to the centre of a free main chord between two node points.

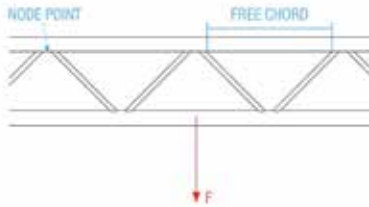

Load application at the free chord between two node points

Applying slinging hitches to trusses is often regarded to be at a 90° angle to the centre line of the main chords. In trusses with an alternating pattern of the diagonal members in the horizontal planes between the main chords such as the Prolyte 30 and 40 series, this assumption often leads to the situation that one main chord is slung near a node point and the corresponding main chord is slung near the centre of the free main chord between two node points. It has to be pointed out that it is absolutely not necessary to apply a slinging hitch like that. Without any problem a slinging hitch can be applied at an angle similar to the angle between the diagonal members in the horizontal planes and the main chords, so both corresponding main chords are slung near node points.

Prolyte trusses are designed and calculated in such a way that the weakest part determines the loading capacity of the truss. Since slinging is the load application at single points, the truss will be subject to transverse force at the point of slinging. The allowable transverse force is limited by the diagonal members of a truss. As a general rule the diagonal members that connect the top and bottom main chords are the weakest members of a truss (except for the truss type H20LB). This enables all Prolyte trusses to be suspended from the top chords only and exclusively loaded at the bottom chords.

Straight trusses tend to rotate around their centre line because of unbalanced load application. The chosen sling hitches shall counteract the rotation since the trusses are not calculated for being loaded in rotated positions. In two-dimensional truss structures like truss square frames, triangles, polygons or circular trusses rotation of the trusses around their centre lines is prevented by the structure itself and simple sling hitches are possible.

At the suspension points of a single span truss without significant cantilevers, the truss will be subject to transverse force only. There will be no significant normal forces in the main chords at the suspension points because the normal forces in the main chords and the bending moment of the truss reach their highest values in the centre of the span.

At the suspension points of a single span with loaded cantilevers and at the inner suspension points of multiple-span trusses the truss will be subject to transverse force and bending moment. The slinging will add local bending forces to the main chords that are already under a decent amount of normal force at these positions. Since this interaction of transverse force, global bending moment and local bending moment is not easy to predict, it is advised to integrate all main chords in the slinging hitch.

If you are ever in doubt about slinging a truss at the top chords only, sling all chords of the truss. You will be on the safe side.

As already mentioned, the number of different ways to sling a truss is probably infinite. The slinging hitches shown in this book have been proven in practice and are just an indication.

1. TRUSS

TRIANGULAR TRUSS | APEX UP

1 SLING, INVERTED BASKET ON BOTTOM CHORDS



1

TRIANGULAR TRUSS | APEX DOWN

1 SLING, BASKET ON BOTTOM CHORD AND WRAPS ON TOP CHORDS

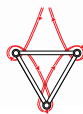

2

TRIANGULAR TRUSS | APEX UP

2 SLINGS, CHOKES ON BOTTOM CHORDS



3

TRIANGULAR TRUSS | APEX DOWN

2 SLINGS, CHOKES ON TOP CHORDS

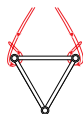

4

TRIANGULAR TRUSS | APEX DOWN

1 SLING, INVERTED BASKET ON TOP CHORDS

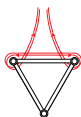

5

TRIANGULAR TRUSS | APEX DOWN

1 SLING, BASKET WITH WRAPS ON TOP CHORDS

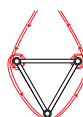

6



RECTANGULAR TRUSS

2 SLINGS, CHOKES ON TOP CHORDS

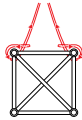
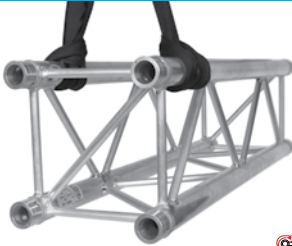

7

RECTANGULAR TRUSS

2 SLINGS, CHOKES ON BOTTOM CHORDS



8

RECTANGULAR TRUSS

2 SLINGS, CHOKES ON BOTTOM CHORDS WITH WRAPS ON TOP CHORDS

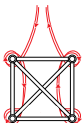

9

RECTANGULAR TRUSS

1 SLING, INVERTED BASKET ON TOP CHORDS

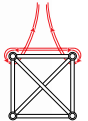

10

TWO CHORD TRUSS

1 SLING, BASKET ON TOP CHORD



11

Note: Never sling straight spans of two chord truss at the bottom chord!

1. TRUSS

1.7.5 Lifting Brackets

Instead of slinging truss with flexible lifting accessories, non-flexible lifting accessories like lifting brackets – also known as truss adaptors – can be used to suspend trusses. In some applications lifting brackets provide advantages and in other applications they are unsuitable. In general, lifting brackets and truss clamps are not qualified to take diagonal forces, so they are not the right choice for truss bridles. Mounting of lifting brackets is more time consuming than applying slinging hitches and usually a wrench is needed. Placing a lifting bracket inside of a truss makes it difficult to het the clamps in vicinity of the node points of the truss.

Lifting brackets offer the opportunity of having their lifting eyes at the same height above or underneath a truss due to very low tolerances. While the accuracy of slinging hitches depends on the skills of the persons who apply them to trusses, Lifting brackets can be mounted easily by everybody. A major advantage of lifting brackets is their heat resistance. Lifting brackets are widely found in permanent installations where flexible lifting accessories are often not accepted. Lifting brackets are available for many different sizes of truss and do not open discussions about horizontal forces between main chords.



Lifting Bracket WLL 500kg



Lifting Bracket WLL 1000kg

Lifting brackets - correct and incorrect application (New drawing with correct products)

1.7.6 Storage and transport

Trusses shall be stored indoors in appropriate storage equipment. In many cases straight truss modules are stored standing upright side by side. It is recommended to prevent the trusses from tipping in order to prevent a domino-effect. The connectors at the bottom end shall be protected from scratching on the ground either by placing a protected layer on the ground or by using connecting elements (conical couplers) permanently mounted to the connectors at one end of the truss module and making the trusses stand on the connecting elements. In case of wear and tear the connecting elements will be damaged instead of the not replaceable connectors of the truss module.

If straight truss modules can be stored horizontally the truss modules should be prevented from scratching at each other. So called truss carriers can do the job perfectly and will also care for a proper alignment of the stacked trusses. These truss carriers are also used when transporting trusses on dollies. Mind the height of packed truss dollies regarding the risk of overturning. Make sure that all people involved in the transport of trusses are instructed in the safe handling of the transport equipment. Transport has to be done without damaging the trusses. Especially forklift operators from other industrial sectors try to stick the fork through

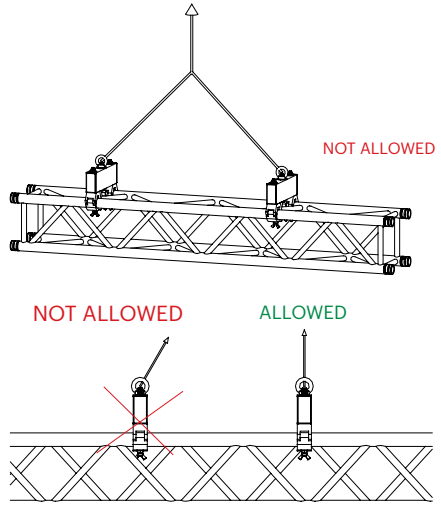



Photo: LT Roof, Aku's Factory, Finland

the lattice structure of the trusses as a compulsive act. Almost all damaged diagonal members of a truss have been a victim of forklift operators.

1.7.7 Inspection and discard criteria

Every employer is obliged to provide safe work equipment to workers at work. Every worker is obliged to use safe work equipment only. The way to make sure if the equipment is safe is inspection. A visual check of the equipment before each use, independent of the respective field of utilisation, should go without saying. In many countries the inspection of work equipment is enforced by law. Prolyte recommends that periodic inspection of the trusses, associated structural components and connecting elements shall be carried out and documented by a qualified and competent person at least once a year. If the trusses are used intensively, periodic inspections should be performed at shorter intervals.

If deficiencies that preclude a safe use are identified during an inspection, the truss has to be taken out of service and if the deficiency cannot be removed or

repaired the truss has to be discarded. Marking of the deficiency cannot be considered sufficient in most cases. Disposal via the manufacturer/supplier or a metal recycling company is the only safe way of protecting others from risks generated by defective material. The criteria defined by Prolyte for discarding trusses shall be respected when inspecting trusses.

General

Trusses shall be discarded if they display one or more of the following criteria. In case of doubt the manufacturer/supplier or an expert should be consulted for their opinion.

If you cannot identify a truss before inspection it might not be a Prolyte Truss. If the identification mark is gone or unreadable you might not be able to identify the date of manufacture, but you will always identify a Prolyte truss by the markings on the connectors, and the combination of the outer dimensions of main chords and members.

1. TRUSS

Permanent (plastic) deformation of the truss modules by rotation, bending or torsion or other deformation with resultant deviation from the original shape.

Welds which have cracks or other visible irregularities. The incomplete welding seams around the diagonal braces of the 20, 30 and 40 Series are production-related and their adequate stability has been proven.

Reduction of the raised level of the welding seam by mechanical wear by more than 10%.

Excessive corrosion whereby the total cross-sectional area of the truss is reduced by more than 25% of the thickness or more than 10% of the cross-sectional area of the component.

Although aluminium may not develop visual corrosion the way many steel alloys do, ambient influences can have a corrosive impact on aluminium. Particular care should be taken with structures that are placed outdoors for a long time, especially in areas with a high level of industrial pollution. Trusses used in coastal areas or close to swimming pools should be checked individually before each use due to the greater likelihood of these environments causing corrosive effects.

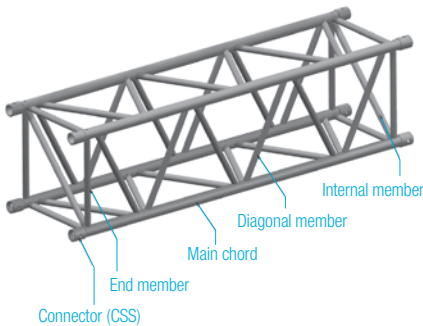

Elements of a truss

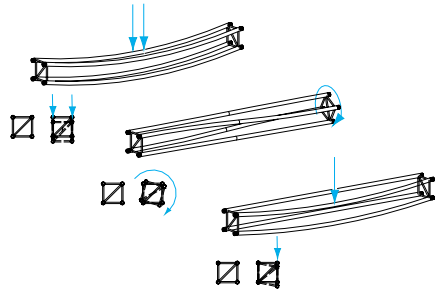

Types of deformation: deflection, torsion, rotation.

Main chords

If a main chord shows cracks, is broken or is permanently deformed by more than 3mm from the original centre line between the node points, the truss must be taken out of service. The same applies if the ends of the main chords of a truss are bent in the area around the conical coupler in such a way that connecting the module to another module is only possible by applying considerable force.

Further discard criteria for main chords:

Scratches, cuts or other signs of wear like abrasion on the surface of a main chord that reduce the wall thickness by more than 25% or the cross-sectional area of the main chord by more than 10%.

Indentations/dents deeper than the wall thickness.

Holes or openings appearing in the main chord appear after the truss has been placed on the market.



Plastic deformation of the main chord to an oval shape more than 5% of the respective diameter.

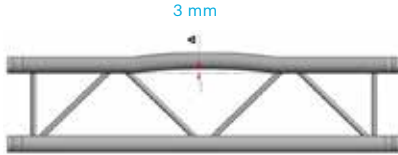

Permanent deformation of a main chord.

The main chord is distorted or constricted next to the welds due to excessive tensile force.

Members (diagonal, end, internal)

If one or more diagonal or end members are broken or missing, the truss must be taken out of service.

A brace is displaced from the original centre line by $L/300$ (length divided by 300) or 3 mm (0.12 in), whichever has the smallest value.

Further discard criteria for members:

Scratches, indentations or signs of attrition on the surface of the section that reduce the wall thickness by more than 25% or the cross-sectional area of the tube by more than 10%.

Drill holes or openings appearing after the truss has been taken into use.

Cracks or breaks in a brace.

Corrosion causing loss of material.

A brace shows a deformation to an oval shape by more than 5% of the respective diameter.

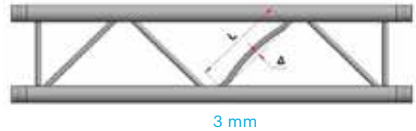

Permanent deformation of a diagonal member.

Connectors

If a connector is broken or missing, the truss must be taken out of service.

Further discard criteria for connectors:

Cracked or partially broken welding seams between the main tube and the connector.

Enlargement or oval signs of the conical drill holes greater than 10% of their respective diameter.

If a connector is deformed to such an extent that the truss can only be connected to another element by using considerable force.

Signs of wear on the connector that reduce the wall thickness by more than 25%.

Any deformation or distortion in the main chord area next to the welds of the connector.

Scratches, cuts or hammer stroke indentations on the connector to a depth of more than 2 mm (0.08 in) and that are longer than 10 mm (0.39 in), regardless of the direction.

1. TRUSS

Excessive corrosion inside of the connector.

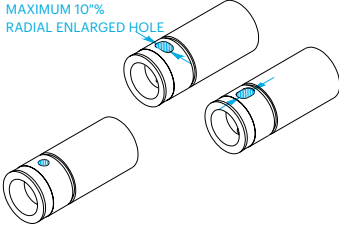

Enlargement of the conical drill holes

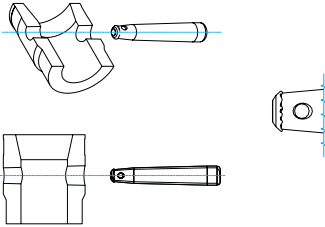

Deformation of the conical pins

Connecting elements

The conical spigot pins undergo wear when inserted and removed frequently, in particular by hammer strokes. They can be regarded as consumer goods. Pressure areas and deformation of the pins are indicators of a massive overload. If a pin shows such a damage, it has to be replaced.

Further discard criteria for connecting elements:

- Decrease of the diameter by more than 10%.
- Burrs, mushroom heads and other protruding, sharp or pointed edges at the narrower end of the conical pins.
- Deformation through hammering which causes wear on the cross-hole for the safety clip or damage to a screw thread.

Documentation

Periodic inspection should be documented in a suitable way. It is not necessary to write an inspection report for every truss that has been inspected. This would lead to unrealisable work if it comes to a large inventory. Prolyte recommends to mark each inspected truss with the date of the inspection, the date of the next inspection and the name of the competent person that has inspected the truss. A collective report about all trusses of one type that have passed the inspection should be sufficient and only those trusses that have been identified to be taken out of service should receive an individual inspection report as long as they are not directly discarded after inspection.

If there is any doubt about the usability of a truss, it should immediately be taken out of service under any circumstances. Get in touch with an expert or your Prolyte supplier for further investigation.

Maintenance and servicing

During periodic inspection smaller damages and dirt can be remedied by the competent inspecting person.

Aluminium can build up on the inner side of the drill holes of the connectors, which should be removed from time to time with medium grained sandpaper (grain240 or higher).

Remains of spray paint, adhesive tape residue, dirt, dust and other contamination shall be removed frequently in order to keep the truss in a good visual condition.

Some companies use spray paint to mark their trusses. Care should be taken that no paint gets on the fitting surfaces of the connectors and connecting elements since these are manufactured very precisely. Drops of paint can be five times thicker than the manufacturing tolerances and can cause the truss modules to be assembled more difficult.

Farinaceous residue on the connectors and conical couplers are not unusual and can be removed with water and lint-free cleaning cloths. Aggressive cleaning agents and acids should not be used to clean trusses and accessories. Exterior soiling of the trusses, e.g. with glue residue, can be removed with soap or high



pressure cleaner. Cleaning cloths offered by adhesive tape manufacturers can be used if they are declared to be harmless to aluminium alloys.

Prolyte and all Prolyte distributors/sales partners offer regular workshops and training courses on the safe use and handling of Prolyte products. For more information see www.prolyte.com

Repair of Prolyte aluminium truss

Prolyte does not offer any repair of truss, associated structural components or accessories.

Since there are no legal requirements regarding the repair of trusses used in entertainment technology, the owner of the truss is free to decide about his own property.

Any repair of Prolyte truss will be carried out under the full responsibility of the owner of the truss. Prolyte refuses any warranty for repaired truss modules, associated structural components or accessories. In some countries the person that carries out repairs of trusses might be considered to become the new manufacturer of the trusses.

The only repair of a damaged truss could be done by replacing damaged members of the lattice structure of a truss module.

While the diagonal members have a minor influence on the accuracy of the connections of a truss module and are easy to be replaced, the replacement of the end members always lead to a deviation of the accurately fitting of the connections and is therefore not advised.

Main chords and disrupted or cracked conical connectors must not be repaired.

Replaced members of the lattice structure and the repaired truss module shall be marked in a sufficient manner in order to recognize replaced members and repaired trusses after a first repair. The welder has to be qualified for the required welding process. The alloy and the dimensions of the parts to be replaced and the welding consumables have to be the same as those that are used in production of the trusses.

Before the repair will be carried out, the truss has to be inspected by a competent person for regular inspection of Prolyte trusses. This competent person should be trained and certified by Prolyte.

After the repair, the welds have to be visually inspected according to the applicable standards that are legal in the country the repair is done. It is highly recommended to get in touch with your Prolyte supplier before any repair is done.

1.7.8 Equipotential bonding (Grounding)

Every time a truss or truss structure is used in combination with electrical equipment – which is nearly always the case – a protection against electrical shock is mandatory, in particular, if people can touch the truss, e.g. at ground supported structures in exhibition halls!

This protection is realised by equipotential bonding – widely described as electrical grounding – of the trusses or truss structures. The effectiveness of the equipotential bonding needs to be verified by measuring the earth resistance by means of appropriate measuring instruments operated by a qualified electrically instructed person.

1.7.9 Safety at work - climbing on truss

General

Climbing on trusses shall always be avoided. Working at height always implies the risk of falling from height which can cause injuries or death. In those situations where external access through mobile elevating work platforms like aerial devices or scissor lifts is not possible, climbing trusses might be the only way to reach a position where work has to be done.

If you cannot avoid climbing trusses, always carry out your own risk assessment in order to minimize the risk of any mishap before you leave the safe ground.

Never climb alone! Always make sure that there is somebody qualified, able and equipped to rescue you from any height in case of a mishap. If that somebody wants to use an aerial device to rescue you, ask yourself why you need to climb instead of using that aerial device.

Prolyte strongly emphasizes not to climb on truss if it is not proven that the truss is able to withstand the forces of people moving on the truss and the forces of the impact generated by activated fall arrest equipment. Generally all trusses of the Prolyte E-series, H20LB-series 30L-series, 30D-series, 40L-series and 40D-series are not suitable for climbing due to their relatively low load bearing capacity. But even the stronger truss types need to be carefully analysed, in particular if they are already loaded with equipment. Always make sure that you're not overloading the truss by climbing on it.

In every work environment all persons are obligated to use and wear Personal Protective Equipment (PPE). It is the responsibility of all employers to make sure that all mandatory PPE items are available on site for every employee and to make sure that the employees wear and use this PPE. It is the responsibility of all persons involved to take as little risk as possible for themselves and all others during their work.

Suitable work equipment and PPE for work at height should be determined and selected by the risk assessment.

The most important PPE for climbing trusses are a full body harness, a lanyard with shock absorber and fire-hook and an eligible helmet. The shock absorber is designed to reduce the force of a fall to a maximum of 6kN (which equals approx. 600 kg).

Climbing on horizontal truss

Whenever climbing on trusses cannot be avoided it is mandatory to prove that the truss is able to withstand the forces generated by the impact of a falling person arrested by the shock absorber (6kN). This load assumption will generally cover a person hanging in his harness and a second person moving on the truss in order to perform a rescue.

It is obvious that members are weaker than main chords but even main chords might be too weak to resist the forces created by the impact of a falling person, in particular when the truss is loaded with equipment. Never use members as anchorage for your PPE! Only use main chords as anchorage if it has been verified by qualified persons that the main chords of the truss can take the forces as described above.

Horizontal lifelines

Tying ropes to trusses is a common way of generating lifelines with the feeling of being safe at height. This is an absolute naïve and unsafe approach! No matter what kind of type of rope is used, there is no point at a truss that is approved to be an anchor point for a horizontal lifeline! Often it can be seen that horizontal lifelines are fed through shackles or master links between chain hoists and slinging hitches. It needs to be respected that a hoist manufacturer would hardly give his approval if asked for resistance against a shock load generated by a falling person!

Only trust a lifeline installation if it is either certified by a notified body and installed according to an available manual or is approved by a structural engineer and the manufacturers of the involved equipment in writing. Prolyte recommends to use steel wire lifeline systems with dedicated anchor points for trusses that have been proven to be able to transfer all forces through the truss, into the support points and further to a building or the ground, although it is hard to find any.



Climbing on vertical truss

Whenever it is unavoidable to climb on a truss structure that is supported from the ground, the climber will usually climb on the towers first. This is often estimated to be a non-hazardous action but it is not! If the tower truss is not equipped with extra members that are arranged as rungs of a ladder, the climber is forced to step on the diagonal members of the tower truss. This is no problem if the climber is experienced but carries a certain risk of hurting the feet or slipping off the diagonal member. Caution is advised when H30V towers need to be climbed on, the relatively weak diagonal members could be damaged by stepping on them with unbridled violence. The fire hooks of the Y-shaped lanyard shall always be hooked on the main chords if no horizontal lifeline is installed.

Vertical lifelines

Professional people install vertical lifelines to towers and the climber uses a travelling fall arrester running on the vertical lifeline. The upper end of a vertical lifeline shall be attached to the top section of the tower or a verified point at a boxcorner. The lower end should be attached to the base section of the tower. Ropes can be used as long as they are proven to be strong enough. The majority of travelling fall arresters are designed to be used on ropes.

1.8 RULES

People involved with entertainment technology often experience discussions about what is allowed, accepted or forbidden to do or use in our industry. As a manufacturer that started in the Netherlands, Prolyte always referred to national rules, rules of its neighbour countries – in particular to the harsh rules in Germany – and to European Regulations, directives and standards. Nevertheless we always look at all rules we learn and get access to. It would go beyond the scope of our Blackbook to try to mirror all rules applicable to entertainment technology in the world, so we try to focus on the major rules our products and their safe use are based on.

1.8.1 Laws and legislation

There are no known laws that directly govern truss used in entertainment technology. In some countries there are national health and safety regulations with the same status as a law mentioning truss or truss structures like the German DGUV regulations or British HSE regulations. National Laws in the European Union governing product safety, safety at work, use of work equipment, construction products and so forth are based on European regulations and directives and cover a vast range of products and their applications including trusses and accessories. Trusses are not directly mentioned in these regulations and directives but are affected by them in some situations. It's worth to know that a European regulation overrules national laws of the member states of the European Union, while European Directives deliver the basis for national legislation.

The Construction Products Regulation (CPR) EU 305/2011 governs construction products that are intended to become an integral part of permanent construction works like buildings or bridges and having an influence on the structural safety of the construction work. The CPR also defines the exigency for CE-marking of products governed by it. Trusses are generally not intended to be used as integral parts of permanent construction works. Trusses are used to set up temporary demountable structures (TDS) which are not covered by the CPR. But the CPR is interlinked with European Standards on execution of aluminium

structures and structural design standards that deliver the basis for design and manufacture of trusses in entertainment technology. It seems to be complicated and it definitely is.

Trusses that are not intended to become an integral part of civil construction works cannot be CE-marked according to the CPR. Therefore Prolyte trusses generally do not bear the CE-mark as defined by the CPR. The Personal Protective Equipment Regulation (PPER) EU 2016/425 governs the requirements for the design and manufacture of personal protective equipment (PPE).

The Machinery Directive (MD) 2006/42/EC is more specific and governs machinery, interchangeable equipment, safety components, lifting accessories, chains, ropes and webbing, removable mechanical transmission devices and partly completed machinery. Straight trusses could be regarded as lifting accessories governed by the MD. The MD defines lifting accessories to be 'a component or equipment not attached to the lifting machinery, allowing the load to be held, which is placed between the machinery and the load or on the load itself, or which is intended to constitute an integral part of the load and which is independently placed on the market'. The MD further demands that lifting accessories must show the maximum working load directly on the product or on a plate or equivalent means, securely affixed to the accessory. As we already know, the maximum working load of trusses changes with the length of a truss span. Since truss modules can be combined in countless different combinations to form a truss span, it is impossible to demand for a marking as defined by the MD. As soon as truss modules are connected to associated structural components like corner modules or sleeve modules the maximum working load cannot be defined upfront. Anyway corner modules and sleeve modules cannot be rated with a maximum working load. Therefore Prolyte trusses and associated structural components generally do not bear the CE-mark as defined by the MD.

The directive 'use of work equipment' 2009/104/EC governs the minimum safety and health requirements for the use of work equipment by workers at work. Among many other things this directive covers working

at height and inspection of work equipment and thereby delivers the necessity of periodic inspection of trusses.

1.8.2 Standards

Standards define the state of technology. We are facing three major types of standards: national, continental and international. They do not follow a strict hierarchic structure. European EN standards defined by CEN generally overrule and replace standards of national standardization bodies (NSBs) like BS, DIN, NEN, etc. International ISO standards do not overrule EN Standards, they have to be adopted by CEN to become EN ISO standards. After that they can become national standards as well e.g. BS EN ISO, DIN EN ISO or NEN EN ISO. The NSBs are also free to adopt ISO standards without the adoption through CEN. These standards will be e.g. BS ISO, DIN ISO or NEN ISO.

While only a few countries developed national standards in dealing with entertainment technology, there has been a lack of equivalent EN standards for decades. In the year 2006 a bunch of enthusiastic veterans from the entertainment industry gathered at CEN in Brussels to create a CEN Workshop Agreement (CWA). A CWA is considered to be a suggestion for an EN standard, showing that there is interest and consensus about standardising specific industrial demands on European level. In December 2008 CEN released CWS 15902 'Lifting and Load-bearing Equipment for Stages and other Production Areas within the Entertainment Industry' in two parts: Part 1 'General requirements' and Part 2 'Specifications for design, manufacture and for use of aluminium and steel trusses and towers'. Part 2 had been based on the American standard ANSI E1.2-2006 'Entertainment Technology: Design, Manufacture and Use of Aluminium Trusses and Towers' and on the British standard BS 7905-2:2000 'Specification for design and manufacture of aluminium and steel trusses and towers'.

As a nature of a CWA, it is given a lifetime of 3 years until it has to be converted into an EN standard with the opportunity to be prolonged for another 3 years. Until 2011 no member of CEN had been willing to take the lead in converting CWA 15902 into an EN standard, so it got prolonged for another 3 years. In



the year 2014 the German standardisation institute DIN managed the funding of the technical committee CEN TC 433 'Entertainment technology' and started with standardisation in three of four working groups. The working group 2 'Work equipment and installations' started the conversion of CWA 15902-2 in February 2015 and finished the work in September 2017. CEN released the very first European standard on Entertainment Technology, EN 17115 'Entertainment technology – Specifications for design and manufacture of aluminium and steel trusses' in August 2018. Since then all Prolyte trusses, associated structural components and accessories are manufactured accordingly to this standard. EN 17115 refers to the applicable standards of the Eurocode series, EN 1990 to EN 1999, the execution of steel structures and aluminium structures, EN 1090 Part 2 + 3 and the necessary standards covering material specifications.

In the United States ANSI E1.2-2006 has been replaced by ANSI E1.2-2012 'Entertainment Technology – Design, Manufacture and Use of Aluminum Trusses and Towers'. Except for a few differences in the terminology and references to continental manufacturing and material specifications, the content of this ANSI standard is similar to EN 17115.

1.8.3 Codes of practice

Codes of practice are generally defined by trade organisations like PLASA, IGWW, ESTA, etc. or by groups of interested people like in the recent 'international code of practice for entertainment rigging' (ICOPER). Codes of practice define the state of the art of working in an industry, giving recommendations on the safe use of work equipment, efficient work techniques, terminology or health and safety at work, respecting applicable legislation and standardisation, not excluding deviant solutions if they guarantee an equivalent level of safety. Following codes of practice gives confidence to all persons involved to maintain the required level of safety. Prolyte would like to encourage all users to gather information about all applicable codes of practice that are necessary for their safe work, read and understand the content and fulfil and maintain the defined recommendations.

1.8.4 Structural calculation

Structural calculation is carried out to prove if a truss or truss structure is stable and has sufficient load bearing capacity. All Prolyte truss series are proven by structural calculation resulting in the loading tables of single span trusses with the maximum allowable loading and the design internal forces of the truss and its components. As soon as it comes to multiple-span trusses or truss structures the loading tables are no longer applicable, they just can be used as an indication when following our rules of thumb for the assessment of a safe setup. The design internal forces will be needed by a structural engineer or an adequately qualified person to perform a satisfactory structural calculation. Structural calculation must always follow all applicable standards defining structural design and material specifications.

It has to be emphasised that structural calculation will always consider the worst-case situations with the maximum expectable actions on the structure and the maximum allowable utilisation of the trusses and associated structural components. In situations where trusses or truss structures are obviously loaded with a small fracture of the possible loading and truss structures are apparently stable against collapse, sufficiently experienced and qualified persons might also be competent to judge if the situation is safe enough. Anyhow we see unsafe truss setups day by day all around the world. Hence Prolyte recommends to have an individual structural calculation in advance for every truss setup.

1.8.5 Compatibility

From a distance all trusses look the same. On closer examination, however, differences become apparent. Joining together trusses from different manufacturers places a high risk of liability on different parties: the user, the employer, the owner and the manufacturer/distributor. This risk is based on the effect of different legal spheres such as product safety, product liability, warranty and reliability as well as stability and load bearing capacity.

The connection of trusses from different manufacturers - which is often stated to be compatibility - is almost impossible from a legal point of view. The person who

connects trusses from two manufacturers is directly considered to be the manufacturer of a new product, as it can be excluded that both manufacturers confirm that their products are compatible with competing products. Prolyte explicitly states that Prolyte trusses may not be connected to the trusses or associated structural components of any other manufacturer in one span.

According to the European directive on liability of defective products 1999/34/EC, the manufacturer is the person who imports or distributes a product for the purpose of sale, hire, leasing or any form of distribution for economic purposes in the course of their business within the scope of the agreement on the European Economic Area. If the manufacturer of the product cannot be determined, then each supplier is considered as the producer thereof.

Example: A truss used as a lifting accessory with a length of 7m, assembled of trusses from different manufacturers (type A + type B) is rented. Liability for both manufacturer's is excluded to the directive on liability of defective products 1999/34/EC, if the partial products (type A and type B) itself are flawless and a fault is only created by the manufacture of the final product. In case of damage, only the person who has manufactured the final product will be liable. Which in this example, is the user!

If an employer provides a set of trusses from different manufacturers to an employee as a work equipment (e.g. lifting accessory), the employer is responsible for the safety of the work equipment in accordance with the European Directive on the minimum safety and health requirements for the use of work equipment by workers at work 2009/104/EC:

'The employer shall take the measures necessary to ensure that the work equipment made available to workers in the undertaking or establishment is suitable for the work to be carried out or properly adapted for that purpose and may be used by workers without impairment to their safety or health'.

Prolyte explicitly states that a risk assessment for an

assembled truss provided and used as work equipment must always include a proof of the stability and load bearing capacity. Prolyte rejects any warranty claims that may be derived from damage due to improper connection of Prolyte truss with any truss from other manufacturers. With regard to the stability and load bearing capacity of assembled trusses from different manufacturers, we explicitly point out that even the smallest tolerances in the connection elements can drastically affect the load bearing capacity.

The widespread opinion, that with the connection of trusses from different manufacturers the loading data of the weaker truss are considered as sufficiently secure, is free of any physical and legal basis. Different material properties and manufacturing processes lead to different allowable internal forces of the various truss types. An individual proof of the stability and load bearing capacity of assembled trusses from different manufacturers would therefore always be required. This cannot be reasonably implemented in daily practice. Prolyte trusses and associated structural components are not placed on the market to be used in combination with trusses of other manufacturers, but can be used in combination with lifting accessories or lifting devices that are independently placed on the market, although Prolyte would love to see everybody to use entirely Prolyte Products.

Prolyte expressly states that Prolyte trusses and associated structural components must not be connected with trusses from other manufacturers!



1.9 TECHNICAL PROPERTIES OF PROLYTE TRUSSES

The knowledge about the unique technical properties of Prolyte truss modules, associated structural components, accessories and their combinations are of great importance regarding clever preparation and efficiency on the job. In this chapter we try to get an insight to some technical properties.

1.9.1 Dimensions (12.1)

Knowledge about the dimensions of Prolyte truss modules and associated structural components can prevent you from experiencing unexpected difficulties when assembling truss structures.

Dimensions of corner elements

Since the beginning of producing truss corner modules we have been asked why the length of the corner modules of the 30-series differs from the wide-spread 500x500x500cm dimensions of other manufacturers. The explanation is quite simple. Due to the countless combinations of corner modules, already in two-dimensional truss grid structures it has to be expected that a T-shaped corner module or a cross corner module meet with a two-way corner module. This shall be possible without the need of special length truss modules, so the inner dimension of a leg of a 90°-corner module always has to be the same. Starting with a 2-way corner module of the X-series with the outer corner module dimensions of 500x500mm and a truss dimension of 290mm, the inner dimension of the legs of the corner will be 500mm - 290mm = 210mm. If this two way corner shall be combined with a T-shaped corner module the inner dimensions of all legs of the corner module have to be 210mm. Since a T-shaped corner module is nothing but a 2-way corner module with an additional leg the overall length of the T-bar sums up to 500mm + 210mm = 710mm. The same applies to a cross corner module of the X30-series.

One of our former 'dirty little secrets' shall no longer be kept as a secret. With the implementation of the H-series which came with the same centre dimension as the X-series (239mm), the outer dimensions of a 2-way corner module had to be 500x500mm as well.

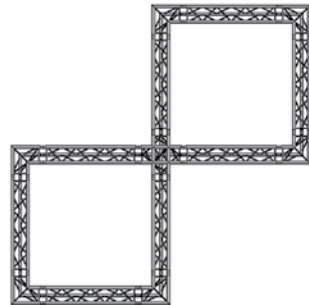
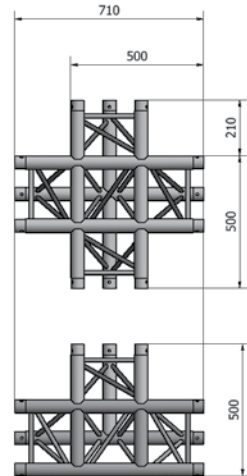

Since the outer diameter of the main chords was 48mm, the outer dimension of the H30 truss came out to be 287mm. The inner length of a leg of a corner is therefore 500mm - 287mm = 213mm. The T-bar of a H30D/V-C017 T-shaped corner module turned out to have a length of 500mm + 213mm = 713mm. Although X-series and H-series trusses can be connected to each other because they are manufactured by the same manufacturer, the combination of X and H corner modules needs to be carefully assessed if it comes to complex structures. In a simple rectangular truss grid the difference of the length do not matter at all. Moreover it shall be known that the tolerance of the length of the main chords is $\pm 0,5\text{mm}$.

1. TRUSS

Dimensions of combinations of MPT sleeve modules and corner elements

The MPT-tower system is a universal ground support system that can be used with all three-dimensional cross section trusses from the 30- and 40 series. The majority of truss grids in a MPT ground support is made from H40V trusses and corner modules. The sleeve module of the MPT system (MPT-010) has different outer dimension than the corner modules of the H40V series. If a centre truss span shall be integrated in the truss grid, we are facing a combination of the different corner module options and the sleeve modules which are equipped with the connecting elements CCS6-602 with an offset of 19mm. The following figure shows the length of a centre truss using standard T-joints (H40V-C017) in an MPT-tower truss grid with CCS6-602 connection elements at the sleeve modules:

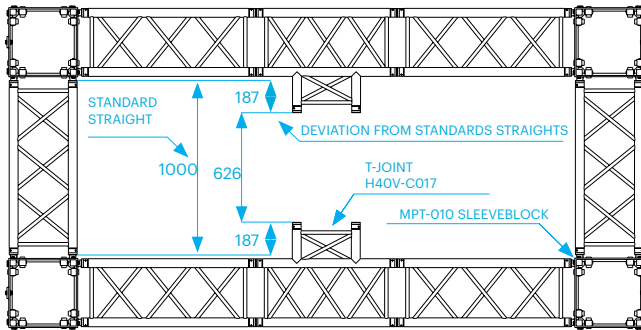

Combination of H40V-C017 and MPT-010

The length of the straight truss module between two corresponding H40V-C017 is $2 \times 187 \text{ mm} = 374 \text{ mm}$ less than the length used between the sleeve modules.

The next figure shows the length of a centre truss using Boxcorners (BOX40V + CCS6-651) in an MPT-tower truss grid with CCS6-602 connection elements at the sleeve modules:

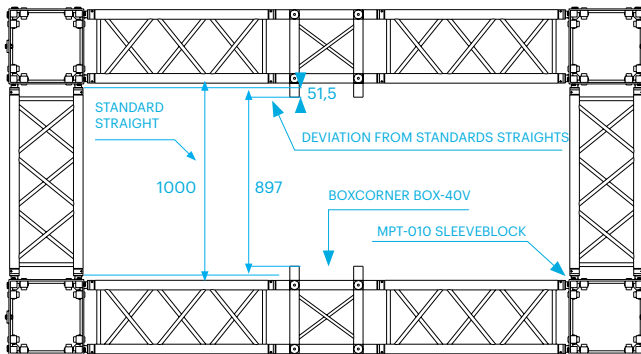

Combination of BOX-40V and MPT-010



The length of the straight truss modules between two corresponding BOX-40V is $2 \times 51.5\text{mm} = 103\text{mm}$ less than the length used between the sleeve modules.

The combination of the relatively unknown connection element CCS6-652S-23,5 at the BOX-40V in the direction of the centre truss span provides a decent advantage. The following figure shows the length of a centre truss using box corners (BOX40V + CCS6-652S-23,5) in an MPT-tower truss grid with CCS6-602 connections at the sleeve modules:

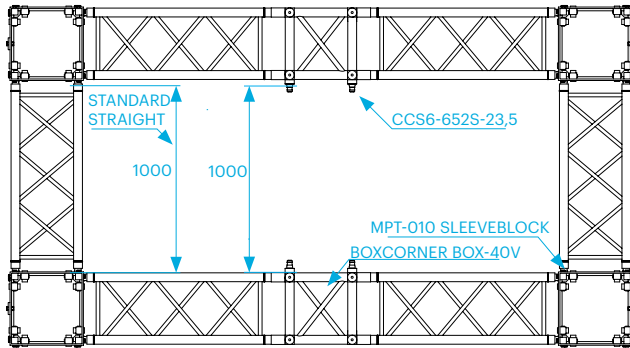

Combination of BOX-40V with CCS6-652S-23,5 and MPT-010

The length of the straight truss modules of a centre truss span between two corresponding BOX-40V with CCS6-652S-23,5 in an MPT-Tower truss grid is equal to the length used between the sleeve modules. No special truss module length is required!

If a second truss span shall be integrated, the types of connecting elements can be chosen accordingly. If a second truss is needed at a 90° angle to the centre span it will be called a centre cross. In this situation another uncommon box corner attachment (BOX-40V-A-002) is recommended.

The following figure shows a centre cross in a MPT-tower truss grid with H40V, BOX-40V, CCS6-652S-23,5 and BOX-40V-A-002 with CCS6-602 connections at the sleeve modules.

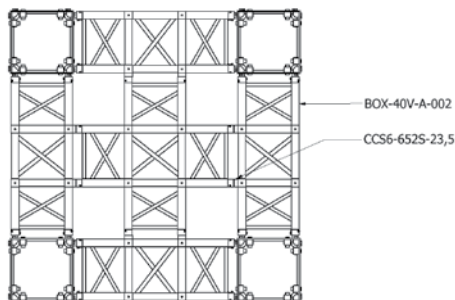

1. TRUSS

The length of all truss modules in all directions can be the same. No special truss module length is required!

In situations where the loading capacity of the H40V truss is not needed or economical aspects (transport and/or investment volume, single-truss-type-only-philosophy or design by stock) come into account, we find the tower truss H30V to be used in the tower truss grid as well. The following figure shows the length of a centre truss using standard T-corners (H30V-C017) in an MPT-tower truss grid with CCS6-602 connections at the sleeve modules:

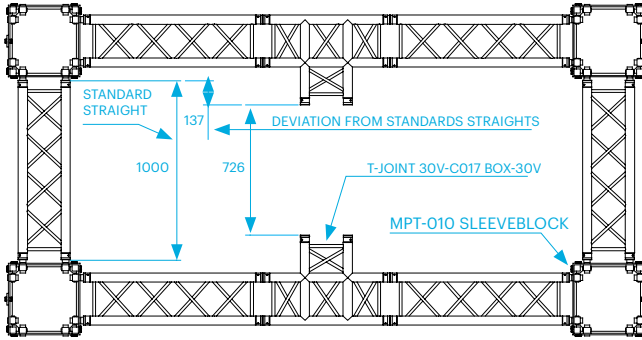

Combination of H30V-C017 and MPT-010

The length of the straight truss modules between two corresponding H30V-C017 is $2 \times 137 \text{ mm} = 274 \text{ mm}$ less than the length used between the sleeve modules.

The following figure shows the length of a centre truss using box corners (BOX30V + CCS6-651) in an MPT-tower system with CCS6-602 connections at the sleeve modules:

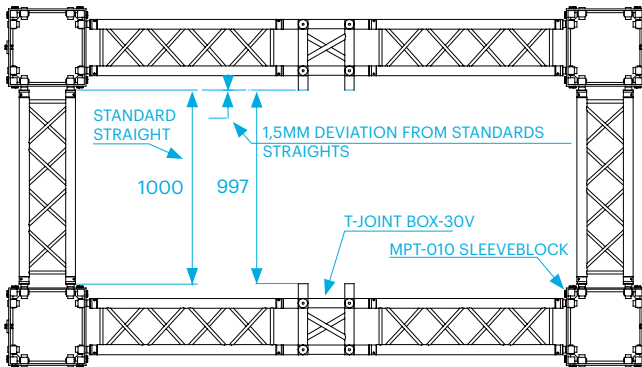

Combination of BOX-30V and MPT-010



The length of the straight truss modules between two corresponding BOX30V (+ CCS6-651) is $2 \times 1.5 \text{ mm} = 3 \text{ mm}$ less than the length used between the sleeve modules.

1.9.2 Hinges

Hinges are primarily used in tower systems, but also and increasingly in special structures. Below we explain the hinge types for three and four chord trusses of the X/H series as well as for trusses of the S/B series.

The hinge most commonly used is CCS6-H. It is used in all MPT and ST tower systems as well as the rigging tower RT-H30V. CCS6-H is a single hinge set and is composed of a fork hinge CCS6-H-FM-45° (A) and a pin hinge CCS6-H-M-135° (B) together with the locking pin ACC-LP016 and the safety clip CCS7-705.

The degree values show the angle between the conical drill hole and the hinge direction. The hinge direction is always at a right angle to the locking pin axis. Older CCS6-H hinges are not identified, new CCS6-H hinges are engraved with their degree values.

Hinges for CT towers are only offered in separated sections, they can be used for special structures of S- and B-series trusses as well. The combinations are countless.

A complete 'set' of hinge sections for a CT tower consists of:

2 x	CCS7-H-60-M-0°
2 x	CCS7-H-60-M-90°
2 x	CCS7-H-60-FM-0°
2 x	CCS7-H-60-FM-90°
4 x	ACC-LP20/60
4 x	CCS7-705

Hinge forks are also available to be bolted to associated structural components like sleeve modules or box corners. Please ask your Prolyte supplier for detailed information

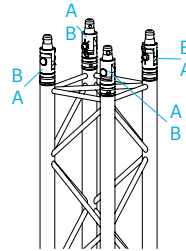

A = CCS6-H-FM-45°
B = CCS6-H-M-135°

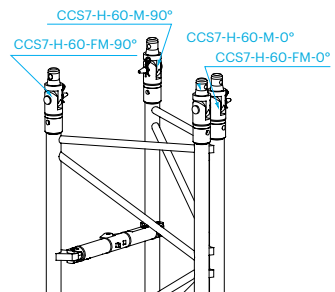
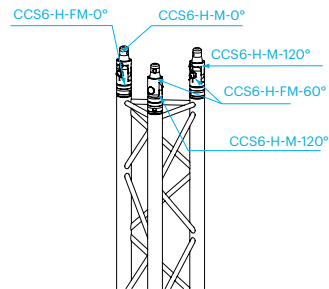

1. TRUSS

1.9.3 Spacer

In several situations the standard lengths of truss modules offered by Prolyte are not sufficient. Since shortening of the length of a truss module is usually quite difficult and leads to the discard of the truss, the extension of a standard truss module is simple. A conical coupler can be made with an extending cylindrical part in the middle providing the opportunity to extend the length of a truss module by 50mm on each end of the module. These extended conical couplers are called spacers. They are available in steps of 5mm up to a length of 50mm by default. It is obvious that these spacers cannot realise every desired length, but it has to be kept in mind that they can be combined with the standard truss module lengths below 100cm like L025, L029, L050, L071 and L075 of the 30-series for example.



It has to be respected, that every set of spacers between two truss modules increases the distance between the end members of the truss modules at the connection. This increases the influence of the interaction of bending moment and transverse force at the connection, resulting in a decrease of the loading capacity of the truss.

1.9.4 Eccentricity at node points

In an ideal lattice structure the centre lines of the members of a truss cross each other in a point on the centre line of a main chord. For several reasons this ideal situation cannot be reached in some trusses, the phenomenon is called eccentricity at node points. These reasons are:

- geometry of the truss
- distance between the end members
- minimum angle of the diagonal members
- diameters of members and main chords
- weldability, space for welding

In the past this eccentricity has been regarded to be a severe deficit in the design of a truss because local bending forces can occur at the node point.

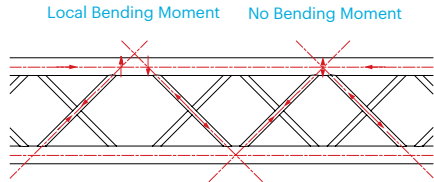

Local bending moment at node point caused by eccentricity (left) - No local bending moment at node point (right)

Since the implementation of the Eurocodes, structural calculation has to pay respect to the interaction of bending moment and transverse force at the connections of truss modules where no diagonals are present at all. This leads to a reduction of the loading capacity of several truss types at short spans. The effect of the interaction of bending moment and transverse force at the connections of truss modules is much bigger than the effect of local bending moments interacting with transversal forces due to the eccentricity at the node points. This leads to the conclusion that small eccentricities at the node points of a Prolyte truss are acceptable without any negative influence on the load bearing capacity of the truss.

1.9.5 Welds of diagonal members

Now and then redundant discussions arise regarding the incomplete weld seam at the connections of the diagonal members in X and H truss series. A brief look into the structural reports of these trusses shows that the diagonal members are considered to be only partly restraint at their welded ends which increases the assumed buckling length of the diagonal members and therewith a higher level of safety is obtained. The length of the weld seam is considered to be no longer than the circumference of the diagonal member. Compared with the length of the weld seam that has an oval shape corresponding to the angle the member is cut and thereby is much longer than the circumference of the



members diameter we find enough headroom to leave out approximately 1/10 of the oval weld seam. The weld seam will always be longer than assumed in the structural calculation and will always be stronger than in theory. As a side effect the saving of just 1/10 of the weld seam saves a lot of energy and production time.

1.9.6 Precambering

In some applications it cannot be accepted that a truss deflects under load. Examples are trusses for large drapes that shall not touch the ground or stiff loads like LED screen brackets. There are a few ways to minimise the deflection under load or even avoid any deflection. The first solution shall be always the first choice: Select a larger truss with a larger height than width.

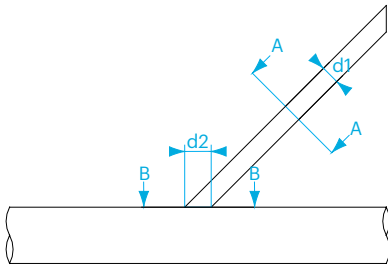

Section A-A --- Circumference = $\pi \cdot d1$

Section B-B --- Circumference = $\pi \cdot d2$

$d1 < d2$

result : surface A-A < Circumference Section B-B

The weld seam around the angled diagonal member is much longer than the circumference of the member which is taken into account in the structural calculation.

Another possibility is to mount special 2mm spacers in the connectors of the top chords of the truss span. This will cause an inverted deflection as well, but again, the inverted deflection is hard to predict according to the variety of truss module lengths and quantity and positions of connections in the span, so it will also be a trial-and-error method to find the adequate setup. Prolyte highly recommends to use special 2mm spacers only, since the longer standard spacers will cause too high local bending forces to the connectors of the trusses. Only qualified, competent and experienced users should perform this kind of precambering.

The smartest solution of precambering besides the selection of a larger truss type is to choose for a special truss type that is prepared for precambering by default. The Prolyte BGR-70 Truss uses connecting elements with different length (0-4mm spacers). The length of the truss modules is a little shorter than the working length, so the ends of the main chords will never touch each other at a connection of two truss modules. All forces are transferred through the connecting elements. This truss type can be used for spans up to 45m.

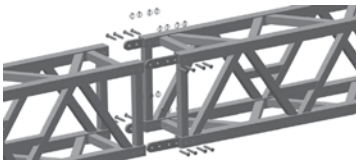

1.9.7 Fire behaviour

Like other common metals, aluminium does not burn. Incomprehensibly, authorities intend to ask for a fire behaviour certification of trusses. Unfortunately Prolyte's answer might be disappointing, but there is no objective to carry out useless certification against

common sense. In other words: there is no certification of the fire behaviour of Prolyte truss.

1.9.8 Stage platforms

Due to the lack of any european standard for stage platforms, the EN 13814 can be taken into account, when looking for load assumptions. Besides that, we find EN 1991, Part 1, 'Actions on structures' (Eurocode 1, Part 1), demanding load assumptions on stages as part of permanent buildings. In most cases a uniform loading capacity of 7,5kN/ m² and a deflection limit of L/200 have been assumed as material design criteria for platforms, while possible point loads on the platforms have been completely ignored.

Eurocode 1 demands a uniform loading capacity of 5kN/ m² and a point load of 3,5kN – 7,0kN on an area of 5cm x 5cm, while EN 13814 prescribes a uniformly loading of just 1,5kN/m² for stages not open for public access, a uniform loading capacity of 3,5kN/m² for areas with universal public access and no point load at all.

Looking at the requirement of Eurocode 1, compared with the technical data of birch plywood, the minimum board thickness would be 35mm – not applicable in the event industry. Therefore the german standard DIN 15921 'Entertainment technology – Aluminium platforms and frames – Safety requirements' has been developed, providing load assumptions adequate for the entertainment industry.

Different standards define values for horizontal forces. These are caused by movements on platforms (e.g. by dancers or stage machines) and additional loads created for example by loads on railings. EN 13814 requires a horizontal load bearing capacity for stages of 10% of the allowable vertical loads; the British standards classify horizontal load-bearing capacity in three classes between 5% and 10%. For synchronous (rhythmic) movements the requirement is also 10%. As a general rule it can be assumed that outdoor stages shall withstand a horizontal loading of 10% of the vertical loading and indoor stages shall withstand a horizontal loading of 5% of the vertical loading.

Looking at the requirements for stage legs, where, for a standard platform of 2 m x 1 m with an allowable vertical



Photo: BGR70, Unlimited Productions, Netherlands

load of 750 kg/m^2 (that is 1500 kg uniformly distributed load) each of the four legs has to be able to bear a horizontal load of 37.5 kg (10% of $1500 \text{ kg} = 150 \text{ kg} / 4 = 37.5 \text{ kg}$). When using circular tubes as legs at a height of 100 cm , tubes with at least $48.3\text{mm} \times 4\text{mm}$ of the alloy EN AW-6082 T6 should be used.

If stage elements are connected to each other to create a stage area, the allowable load bearing capacity could be reduced if the full number of legs is not used.

Prolyte would like to explain this clearly and therefore has published tables with loading data depending on the length and material of the legs.

Stage legs

Principles relating to the use of legs for stages as in the case of trusses, Prolyte also provides information on the load a stage element can support, based on the fact that a stage must be able to withstand a horizontal loading of 10% of the vertical loading.

The horizontal force which a stage element can absorb, depends on the following points:

- Diameter and wall thickness of the leg.
- The leg alloy.
- The leg length.
- The leg connection.

The values stated by Prolyte for the load of their StageDex, versus the height and the legs used are limited by the leg connection. This directly implies that the use of fewer legs means either that the allowable load is less or that the permissible horizontal force of 10% has to be adjusted downwards.

1. TRUSS

Railing for Stages

Whether a railing has to be fitted to a stage or not, is a subject of much discussion. The load that a stage railing has to be able to withstand depends on the use. A distinction has to be made as to whether the stage is open to the public or not. In the case of most pop music stages, a railing that can withstand 30 kg/m is considered to be sufficient. A railing such as this is a clear indication of where the stage ends.

Load reduction example:

If a 100m² stage normally has 200 legs, (4 per 2m², (picture B)), this will change to 66 in the case of a 'hang-on' system (picture A). The load can then be multiplied by a factor of $66/200 = 0.33$. If the load used to be 750 kg/m², this will then become 247.5 kg/m².

By contrast, diverse requirements are 'in the air' when looking for the demands of railings for platforms or grandstands with free public access. The load requirements reach up to 300kg/m at a railing height of 1m.

Such loads cannot be accommodated by existing stage floors, or only with considerable trouble and effort. In particular, the dispersal of the forces is a mayor challenge. The connection between railing, stage and sub-construction has to fulfil stringent requirements. Prolyte relates to DIN 15921 providing railings to withstand a horizontal load of 1kN/m, which means that a 2m railing is able to absorb 2kN.

1.9.9 Standards and regulations for electrical hoists

Industry versus Entertainment application

Hoists as used in the entertainment industry are almost identical to the original industrial versions. The major difference is the use and the position of the hoist vis-à-vis the load. In an industrial environment, a hoist tends to be permanently suspended in what is referred to as a motor-up position, with the hoist being attached to the support structure. In an entertainment situation, hoists are generally used in a motor-down position, whereby not the hoist but the lift chain is attached to the support structure while the hoist stays in the proximity of the load.

Picture A

4	2	2	2	2	2	2	2	2	2	2
2	1	1	1	1	1	1	1	1	1	1
2	1	1	1	1	1	1	1	1	1	1
2	1	1	1	1	1	1	1	1	1	1
2	1	1	1	1	1	1	1	1	1	1

'stage 10x10 m. based on hang-on leg system'
Respectively 4, 2 or 1 leg per stage element

Picture B

4	4	4	4	4	4	4	4	4	4	4
4	4	4	4	4	4	4	4	4	4	4
4	4	4	4	4	4	4	4	4	4	4
4	4	4	4	4	4	4	4	4	4	4
4	4	4	4	4	4	4	4	4	4	4

'stage 10x10 m. based on 4 legs per stage'



The advantage of this is that the cabling can be fitted at operating height and that, instead of the heavy motor housing, the relatively lighter weight of chain needs to be lifted and handled by the rigger.

People located under a live load

Another major difference is that, in the entertainment industry, loads are suspended or moved above people's heads. In a lot of EU countries this Work Equipment (2001/45/EC) is only permitted if additional safety measures have been taken. The Machine Directive 2006/42EC (European legislation) refers to a doubling of the working coefficient when people are lifted. Within the meaning of this directive it can also be asserted that the same applies to lifting above people's heads.

It is unclear whether this directive also applies to immobile suspended loads above people's heads, a situation that is a regular occurrence in the entertainment industry. The European Code of Practice CWA 15902-1, as well as existing standards such as BS 7906-1 / FEM 9756 leave open the possibility of using a 'standard' hoist provided a risk analysis shows this to be justifiable. The Dutch Code of Practice NPR / FEM 8020-10 states that the use of a standard hoist is permitted in this situation provided the working coefficient is doubled, such in accordance with the machine directive. In such cases, a 1.000-kg hoist can only be used for 500 kg. In Germany, a hoist known as a D8+ has to be used in such situations. Besides having a double working coefficient, this hoist also has a double braking system.

Lifting loads above people

As regards moving loads above people's heads it may be necessary to use special hoists. In addition to having overload and underload protection, these hoists may have an operating system that checks the mutual position of the hoists and monitors the loads. In the event of any deviation from the set parameters, the system switches off, thereby guaranteeing safe usage. Such a system is often referred to as a DGUV V17. In Germany such systems are governed by the regulations of the DGUV [German prevention & insurance association].

The equipment and operating technology used depends very much on the situation during hoisting:

- A load on a single hoist makes different demands on hoisting and controlling than a load lifted by four hoists, certainly if more than one of these loads is controlled by one and the same system.
- If the operator has a clear overview of the load and the immediate environment in which hoisting is to take place, it will always be possible to take action in the event of danger.
- What the chance of failure is, and what the risks for all the components used, and their combinations, are.

Currently, a whole series of standards apply to the operation of machines and systems with a safety function. IEC 62061 applies specifically to machine building. This standard is derived from IEC 61508 and deals with the issue of how a safety system can be produced using combinations of 'simple' software, electronics and electrical components. IEC 62061 relates to the specification of the safety level of the specific part of the machine's controls that has a safety function and also assesses the whole range of software, electronics and electrical components. This is expressed as a SIL level.

Simultaneously with IEC 62061, the ISO 13849 standard was created for the mechanical part and components. This standard applies from the mechanical point of view to the reliability of components at component level, instead of to the whole. This standard allows the category and the PL (performance level) of a component to be determined. On contrast to systems, components cannot be categorised into a SIL level.

Double brakes

The use of a double brake is a point that has become open to question. If a hoist generates a doubling in the working coefficient (NPR 8020-10 and D8+), this means that all settings, including those pertaining to the slip clutch and the brake, are increased by a factor of 2 with respect to the operating load.

Fitting 2 brakes to the same shaft would only be advantageous if one brake were to fail. The question is what would happen if the shaft broke, or if one of the

brakes no longer worked? You would not notice any change and yet you would still think you were working safely! The double brakes requirement is derived from the German regulations as drawn up by the DGUV and from the theatre standard DIN 56950-1.

Secondary suspension

What if I do not have a hoist which complies with the above-mentioned standards? Am I obliged to dead hang my load, or do I have to attach a separate suspension device? The lack of specific regulations in the majority of countries means this point is unclear. However, one can state that a chain hoist used to hoist a roofing system must be relieved of the load at all times. In the context of suspending a truss construction, the fitting of a dead hang often entails major risks which are not justified by the increase of the overall safety. The bridging of a chain hoist using a chain clutch is a method which is strongly advised against.

Visual inspection and testing

As is the case with other equipment and machines, the suitability of a hoist must always be assessed before use. This assessment is normally a visual one. If a hoist is used for a long period of time in a hazardous environment, the hoist must be tested (inspected) by a competent person in accordance with the supplier's requirements. Examples of such situations are long-term use outside, use in the rain, use in the vicinity of salt water or use in a sandy environment. Inspections must take place as frequently as is necessary.

Each electrical hoist must be tested at least once a year. The tests and inspections must be performed by a competent person. The person who requests the test/inspection is responsible for making sure that the testing person or company is competent. Therefore in most countries, hoisting and lifting materials, such as those used in the entertainment industry, can be inspected and tested by a 'competent person'. Do not allow yourself to be confused by a person who claims that this work has to be done by an 'accredited or notified body'. However, a notified body does generally have to be called in to test and inspect cranes and passenger lifts.

Duty factor

Chain hoists are classified using what is known as a duty factor. The operating time and starts/stops (indicated in percentages of an hour) indicates how long a hoist may be used at a full load. A 2m classification indicates that a hoist has a 40% operating time with a minimum of 240 starts and stops per hour. This means that a hoist with a hoisting speed of 4 m/min can hoist a maximum distance, with a full load, of $4 \times (60 \times 40\% = 24) = 96$ metres.

IP Explanation and Ratings

EN 60529 outlines an international classification system for the sealing effectiveness of enclosures of electrical equipment against the intrusion into the equipment of foreign bodies (i.e. tools, dust, fingers) and moisture. This classification system utilises the letters 'IP' ('Ingress Protection') followed by two or sometimes three digits. (An 'x' is used for one of the digits if there is only one class of protection; i.e. IPX4 which addresses moisture resistance only).

Degrees of Protection - First Digit

The first digit of the IP code indicates the degree to which equipment is protected against solid foreign bodies intruding into an enclosure.

- 0. No special protection.
- 1. Protection from a large part of the body such as a hand, from solid objects > 50 mm in diameter.
- 2. Protection against fingers or other objects not greater than 80 mm in length and 12 mm in diameter.
- 3. Protection from entry by tools, wires, etc., with a diameter of thickness greater than 1.0 mm.
- 4. Protection from entry by solid objects with a diameter or thickness greater than 1.0 mm.
- 5. Protection from the amount of dust that would interfere with the operation of the equipment.
- 6. Dust tight.



Degrees of Protection - Second Digit

The second digit indicates the degree of protection of the equipment inside the enclosure against the harmful effects of various forms of moisture (e.g. dripping, spraying, submersion, etc.).

0. No special protection.

1. Protection from dripping water.
2. Protection from vertically dripping water.
3. Protection from sprayed water.
4. Protection from splashed water.
5. Protection from water projected from a nozzle.

Hoists are also often used outside, for example at festivals or outdoor events. ProLyft hoists comply with protection class IP54. Classification 4 means that a hoist made in accordance with IP54 is not suitable for use in torrential rain! The hoist always has to be protected with a cover when used outside.

WLL versus SWL

Working load limit is the capacity of hoisting equipment or hoisting tools. SWL is the operating load of a system of hoisting equipment and hoisting tools.

Example:

A H30V truss with a 4 metre span is suspended from two 500 kg hoists. The WLL of the hoist is therefore 500 kg. The H30V truss at a span of 4 metres has a WLL of 1,965 kg.

The SWL is in this case 2x the lifting capacity of the hoists = 1,000 kg – own weight of the truss = +/- 975 kg.

Using hoists in a ground support system

A ground support is lifting a device which can lift a guided load to a desired height using hoists. In a number of countries a distinction is made between lifting a free load and lifting guided loads. In the case of a guided load, and therefore also in the case of a ground support, one has to take into account the friction caused by the guide. This friction depends on the type of wheels and the sagging of the span between the sleeve blocks. A general rule of thumb is that, if a load is lifted using more than two hoists, the hoists may be used to a maximum of 75% of their capacity. Prolyte advises that this rule be observed in the case of ground support systems.



1. TRUSS

Attaching hoists in a ground-support system

Two methods can be used to attach hoists in a ground-support system:

- A. The hoist is fixed to the base and the hoist hook to the truss. The operating load of the truss will then be equal to the hoisting load of the hoist. However, part of the self weight of the trusses and sleeve blocks does have to be deducted.

A. LOAD CAPACITY TRUSS

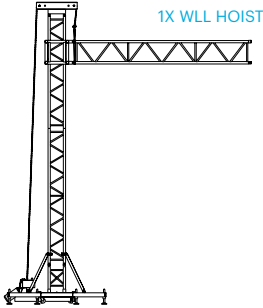

- B. The hoist is attached to the truss and the hoist hook to the sleeve block. This doubles the lifting capacity but halves the lifting speed. Here too, the self weight of the truss construction has to be deducted from the lifting capacity in order to determine the SWL of the construction.

B. LOAD CAPACITY TRUSS

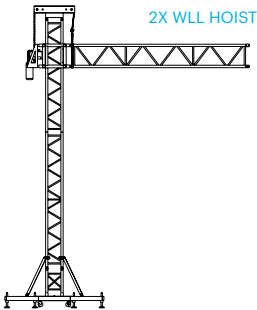

It is very important that the hoist hook and lift hook run in line with the direction of forces. It is not permitted to have the lift chain run with a fleet angle into the chain hoist nor to attach the load hook at an angle, for example to the sleeve block, because this will exert a side load on the hoist housing.

Electrical potential equalisation for truss systems

The user needs to ensure that truss systems that might develop dangerous touch voltages in the event of an electrical fault are incorporated into a common potential equalisation system. This applies to all elements made of electro-conductive material which have equipment placed on, or attached to, them or across which wires and cables run that, in the event of damage, could make electrical contact with metal parts. The connections can be made with clips, pipe clamps, screw joints or special single-pole locking connectors.

The common potential equalisation system must be connected to the earth wire of the electrical power supply system. For cable lengths of up to 50 metres, 16 mm² Cu is considered the standard value for an adequate cross-section. For cable lengths of up to 100 metres, the standard value is 25 mm² Cu. In truss-tower systems, the potential equalisation connection can be made by means of a potential equalisation connection point provided by the manufacturer at the tower base. Since the wheels or rollers used in tower systems with 'sleeve blocks' insulate the movable part of the truss construction, the latter must be provided with a separate potential equalisation connection.

Protection against lightning strike. Electrical installations in temporary structures should be adequately earthed in accordance with normal standards. Consideration should be given to the degree of exposure and likely risk of strike by lightning and, where appropriate, the structure itself should be adequately bonded or earthed. Advice on earthing and lightning protection should be sought from an electrical engineer. In ground-supported constructions the main grid is quite often isolated from the towers because of the use of plastic or rubber castors in sleeve blocks. Thus the main grid needs to be earthed separately, by an earth cable coming down with all other electrical cables.



Which height is which?

2. WHICH HEIGHT IS WHICH?

When rigging in relatively low venues or on outdoor stages, it is very important to have a clear set of references regarding heights. In this chapter we will explain a few of the 'heights' that one may encounter, and what may be understood by them. As many of these terms are not yet defined in any entertainment rigging standard, one must always check whether there is a common understanding of the terms and if they are used correctly in relation to the show-designer's requirements.

Lifting height

This refers to the length of lifting chain of the chain hoist; i.e. the amount of free chain needed at the life-end to do the lift, and at the dead-end to ensure proper pulling of weight on the chain into the chain bag when pushed out of the motor. Another important factor is the number of falls of the lifting chain.

Example:

A 20 m lifting chain of 1 ton capacity reefed into a single fall 1 ton motor, with a 0,2m travel path through the hoist across the sprocket wheel and leaving 0,4m at both the life- and dead-end of the chain, will provide a maximum lifting height of approximately 19m. Here the 'motor down' type of hoist will stay at rest in the flight case and the weight of the chain motor does not need to be lifted out. In case a 20m lifting height is required, the hoist should be equipped with approximately 21m of lifting chain as a consequence. Likewise, a forklift has a specific lifting height, which is less than the overall height of the fully extended telescopic sections.

Note:

To find the required chain length for a tower system, the width of the top section needs to be added to twice the height of the tower, the required length inside and the dead-end part of the hoist. You can subtract the height of the truss that connects to the sleeve block from this height.

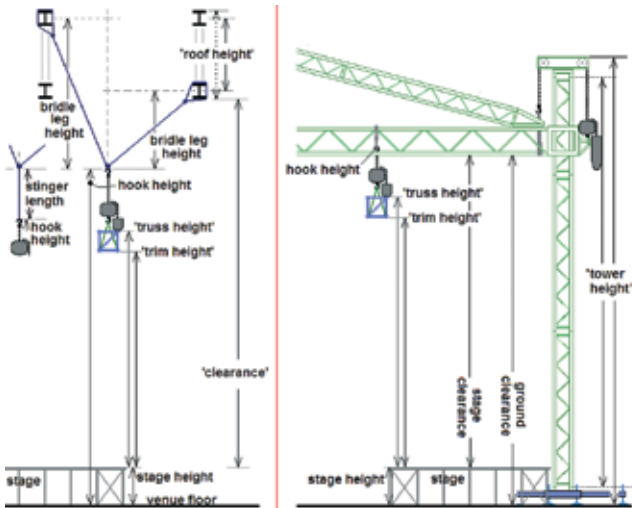



Tower height

At Prolyte, tower height means the length of the tower trusses used as this is the actual working height of a system. The 'overall tower height' is of importance when erecting the tower.

Hook height (covered by NPR 8020-13)

The hook height is often an important part of the rigging plot data. This term refers to the vertical distance between the venue floor and the required height of the upper hook. In a 'motor down' situation this refers to the chain hook. The required hook heights are important when a master grid is the main part over those structures that need to be rigged for the show. Insufficient hook height options in a venue may result in adjusting the programmed travel distances of chain hoist movements, or even the focussing positions of the automated lighting equipment on the truss pods rigged from the master grid. Depending on the height of the venue's main structures, the hook height will set the attachment point in the bottom of the bridle.

Trim height

The term originates from the theatre, and refers to the height where lighting instruments are cut from vision by a black textile border. In the majority of cases this will be the vertical distance between a specific part of an object (truss, set piece, PA cluster) and the venue floor. Lighting designers mostly refer to the lower side of the truss (or a fly-bar in theatre) in relation to the stage surface, rather than to the venue floor.

Sound engineers may take a different view: some will refer to their top cabinets in a cluster or line array, others will refer to the clearance between the lower cabinets and the venue floor, which will be occupied by the audience. Decor designers mostly refer to the height of the lowest parts of the decor that must be clear from the theatre stage or studio floor in order to be hidden behind a border (horizontal black cloth), or to be cleared from view for a camera shot.

For a rigger, it is important to get the right kind of information in order to prepare, plan and rig the show safely and efficiently. He must verify these trim height data references with the specific designer he is rigging the equipment for.

Truss height

Very often this has nothing to do with the lifting operation, but with the elevation of the truss module in the cross section: the X and H30V truss types have a truss height of 30 cm, and the S66V has a truss height of 66 cm.

Note 1:

Occasionally, the term 'truss height' may be used for the upper or lower side of the truss in its lifted position, so with a meaning more or less as in 'trim height'. Even so, if upper chords or lower chords are not specified, this could result in a ground support tower being one meter too low in case S100F or B100 type trusses are planned.

Note 2:

'Trim height' is also used in the automotive industry to indicate the clearance from the road to any part of the underside of the car. Here the term is defined as 'ground clearance'.

Clearance

A general term referring to the unobstructed distance between the (stage) floor and the lowest parts of the main support structure. Better wording would be 'stage clearance' and 'ground clearance' or 'floor clearance'.

Note 1:

Manufacturers such as Prolyte provide information / data on 'clearance', meaning the distance from the venue floor 'substrate' to the lower side of the roof trusses, as the purpose or use and the height of a possible stage are not known. For outdoor roof manufacturers, 'ground clearance' would be a more regular term.

Note 2:

In theatres 'clearance' may indicate the distance from the stage floor to the lower side of the fly bars.

2. WHICH HEIGHT IS WHICH?



Photo: LT Roof, Aku's Factory, Finland

Roof height

This expression is also used in at least two different ways:

- A. as the distance between the venue floor and the lowest parts of main support structure - also known as 'beam height' and therefore almost synonymous to 'clearance'.
- B. The distance between the lowest and the highest parts of the main support structures, also referred to as 'roof structural height'.

Note:

Structural engineers will refer to beams from the dead centre of the cross section, while in 'rigging' the tendency is to refer to the outer distances. The last dimension is important to clear the chain hook from the lower beam if the top chord beam is wrapped. The chain must be able to rotate freely and tip, whereas loading of the hook on a lower beam flange should be avoided at all times.

Bridle height

Is the vertical distance from the top of the hook height (see: hook height) to the location in the structure where the anchorage points are fixed.

Note:

The bridle height is important because, in combination with the horizontal distance to the main structure anchorage points, the lengths of the bridle legs can be calculated using the Pythagorean equation.



Prolyte roof and outdoor structures

Photo: XXL Roof, PROmontaje, Venezuela

3. PROLYTE ROOF AND OUTDOOR STRUCTURES

3.1 INTRODUCTION

Temporary outdoor structures are widely used under all kinds of conditions and circumstances. Prolyte temporary outdoor structures provide a temporary roof above a mobile stage. This roof or temporary structure serves two main purposes:

- To provide shelter from environmental influences to people and equipment.
- To provide a support structure for commonly used equipment such as lighting, sound systems and scenery.

Definition:

Where this text refers to 'the client', this refers to several parties involved in the use, hire, renting or building of the structure, depending on the intended use, context and liability deriving from the actions mentioned in the text.

3.2 PRINCIPAL RESPONSIBILITIES

General

The general requirements for health and safety relating to demountable structures are the same as for permanent structures: a demountable structure should be part of a safe and healthy environment for those using it and should not give rise to risks to the health or safety of users, nor to those involved with the erection, maintenance or dismantling of the structure.

Responsibilities of clients, venue owners and event organizers

Primary responsibility for the safety of people attending an event and of the users of temporary demountable structures lies with the client.

The client cannot pass on responsibility for safety to any third party. The client should make sure that competent people are employed to design, supply and erect temporary demountable structures. The client is responsible for assuring the safety of users of temporary demountable structures through the management and control of users before, during and after an event.

The client must:

- Make sure that requirements for safety in use are met.
- Make sure the contractor provides erection drawings and accompanying calculations, design loads and any relevant test results.
- Appoint a competent person to advise when appropriate technical expertise is lacking.
- Give authorities adequate notice of the proposed use of the structure and when it will be accessible for inspection.
- Have in place procedures for dealing with severe weather conditions during an event, including strong winds and heavy rain.
- Written method statements for erection and dismantling, including for methods of founding evenly on the ground, should be prepared by the contractor and given to the client for further transmission to all relevant parties, including the local authority, if required.

Responsibilities of designers and contractors

- Assess all the relevant scenarios to be certain that the accident risk has been taken into account.
- A risk assessment should be completed in all cases.
- Provide evidence of his/her competence.
- Carry out a final, independent check by a competent person, once the structure has been erected.

3.3 HAZARDS AND RISKS RELATING TO DEMOUNTABLE STRUCTURES

Hazards

The public expect safety in their day-to-day environment and do not take account of the risks that may be present. Hazards are generally defined as circumstances that have a potential to cause harm. A risk is defined as the likelihood that a hazard will be realized. The process of assessing hazards and risks deals with the questions: What if...? How likely is it that...? What are the possible consequences of...?



Hazards during setup and dismantling

Hazards caused during setup may result from factors such as human error, time pressure, inadequate lighting, tired operatives and malfunction of equipment. If they are not detected, such hazards can present a danger to operatives erecting the structures and to users. Hazards may also occur during dismantling. The principal hazards to safety during setup and dismantling include:

- Non-compliance with design and setup documentation.
- Non-compliance with good practice.
- Power or equipment failure.
- External event, e.g. fire, explosion, vehicle impact, wind, snow, earthquake.
- Falling from heights.

Operational hazards

When setup is complete and the facility is open to users, a different set of hazards exists. If the facility has been properly designed and erected, such hazards will generally be the result of external influences. Pre-planning at all stages will minimize their effect. Principal operational hazards include:

Structural:

- Overloading, structural failure or collapsing.

Vehicle impact:

- Extreme external events, e.g. flood, wind, snow, earthquake, lightning.
- Structural damage from any cause.

Crowd behaviour:

- Overcrowding.
- Vandalism or violent criminal behaviour.
- Excitement, demonstrations or incitement of a crowd; fire or explosion.
- Power loss leading to systems failures.
- Spillage of dangerous substances.
- Medical emergencies.
- Accidents.

Risk assessment

All employers are required to carry out an assessment to identify hazards and risks involved in the type of work that could cause injury to performers, employees or the public. Self-employed people are likewise required to carry out an assessment of their work practices. Whenever significant changes are made to work procedures, those assessments need to be reviewed.

The risks associated with any given hazard depend on a number of factors:

- The probability of an incident and a series of secondary events occurring.
- The effectiveness of measures to protect against the hazard and to control an incident.
- The direct consequences if an incident occurs and the indirect consequences afterwards.

3.4 PROCUREMENT AND USE

Specification of requirements

The client should provide the contractor for the demountable structure with a written technical specification of the requirements.

Information checklist

Information provided by the client may include, among other details, the following:

- Site of event and location of the demountable structure at the site.
- Type and details of event, e.g. sports, theatre, festival, conference, concert.
- Programme for supply of structure, e.g. date required, date by which structural calculations and drawings are required for comment, erection timescale, any limit to working hours.
- Type of structure required, e.g. grandstand, marquee, stage; with/without roof.
- Size and weight of equipment to be supported by the stage and roof (where applicable).
- Accommodation needed on and in the structure, e.g. floor area, number of seats, sightlines, access to stage structure.

3. PROLYTE ROOF AND OUTDOOR STRUCTURES

- Public access routes to site; public evacuation times during the event.
- Access to site for erection and dismantling.
- Ground conditions, e.g. flat or uneven ground, hard standing, soft ground.
- Enforcing authority contacts (building control, environmental health and fire officers) to ascertain licensing and approvals requirements.
- Fire risk factors.

Management checklist

The following requirements will help ensure that temporary demountable structures are procured and used efficiently and safely:

- Responsibility for design and erection of the structure and its foundations should rest with the contractor. People with suitable training and experience should carry out erection and dismantling. Design calculations and drawings or a type of approval, together with the independent design check, should be submitted to the client or client's agent.
- The structure should be designed by competent persons using accepted engineering principles and should comply with all relevant standards and guideline documents, as well as with the specification requirements.
- Any alteration should be subject to a further independent design check.
- The contractor and the event organizer should be able to provide proof of public liability insurance cover.
- The structure and its foundations should be protected from vehicular traffic, where necessary.
- After it has been erected, the structure should be subject to a documented erection check by a competent person.
- The structure should be maintained to be fit for use at all appropriate times.
- The client should carry out or arrange for others to carry out periodic inspections and require the contractor or other competent person to undertake appropriate repairs and remedial work as necessary.

Compliance with regulations

It is always the client's responsibility to contact the enforcing authority to inform it of proposals for a temporary structure, and to seek advice on responsibility as regards any requisite enforcement, certificates, licenses and permissions, as well as regarding any special local regulations that may apply. Where an event is required to be licensed, the enforcing authority will check the calculations and drawings. When applying for a license for an event, the client should notify the enforcing authority about which contractor(s) will be supplying the structures. The enforcing authority will then ask the client for the required technical information.

It is the client's responsibility to supply all technical information requested by the enforcing authority in good time before erection starts. Enforcing authorities should raise any queries on the design sufficiently ahead of the start of erection to give the contractor time to deal with any problems. This is a key requirement for any risk assessment and method statement.

Design documentation and technical information should in general be provided at least 14 days before erection starts, and the enforcing authority should respond in writing at least 7 days before erection starts. However, by their nature, temporary structures must often be supplied at very short notice. It is not unusual for an enquiry to be made, an order placed, the structure erected, the event held and the site cleared, all within less than a week.

The enforcing authority may also wish to inspect the structure during and/or after erection to verify that its construction complies with the approved details, that it does not obstruct any exit routes and that, insofar as is reasonably practicable, it does not lend itself to misuse by the public.



BEAUFORT SCALE						
WINDFORCE [BEAUFORT]	WIND SPEED [m/s]	wind speed km/h	Wind speed MPH	Wind pressure Q [kN/m ²]	description	specification on land
0	0-0.2	0 - 0.7	0 - 0.43	≈ 0	Calm	Smoke rises vertically
1	0.3-1.5	0.8 - 5.4	0.5 - 3.36	≤ 0.001	Very light	Direction of wind shown by smoke drift but not by wind vanes
2	1.6-3.3	5.5 - 11.8	3.37 - 7.33	≤ 0.007	Light Breeze	Wind felt on face, leaves rustle, ordinary wind vane moved by wind
3	3.4-5.4	11.9-19.4	7.34 - 12.05	≤ 0.02	Gentle Breeze	Leaves and small twigs in constant motion, wind extends light flag
4	5.5-7.9	19.5 - 28.4	12.06 - 17.65	≤ 0.04	Moderate breeze	Wind raises dust and loose paper, small branches move
5	8.0-10.7	28.5 - 38.5	17.66 - 23.92	≤ 0.07	Fresh breeze	Small trees in leaf start to sway
6	10.8-13.8	28.6 - 49.7	23.93 - 30.88	≤ 0.12	Strong breeze	Large branches in motion, telegraph wires whistle
7	13.9-17.1	49.8 - 61.6	30.89 - 38.28	≤ 0.18	Near gale	Whole trees in motion, inconvenient to walk against wind
8	17.2-20.7	61.7 - 74.5	38.29 - 46.29	≤ 0.27	Gale	Twigs break from trees, difficult to walk
9	20.8-24.4	74.6 - 87.8	46.30 - 54.56	≤ 0.37	Strong gale	Slight structural damage occurs, chimney pots and slates removed
10	24.5-28.4	87.9 - 102.0	54.57 - 63.38	≤ 0.50	Storm	Trees uprooted, considerable structural damage
11	28.3			0.50		
	28.5-32.6	102.1 - 117.4	63.39 - 72.95	≤ 0.67	Violent storm	Widespread damage
	35.8			0.80		
12	32.7-36.9	117.5 - 132.8	72.96 - 82.52	≤ 0.85	Hurricane	Widespread damage
≈13	42.0	151.2	94	1.10		
≈14	45.6	164.16	102	1.30		

$$q[\text{kN/m}^2] = V^2 / 1600$$

Wind pressure

$$V [\text{m/s}] = v[\text{km/h}] / 3.6$$

Wind speed

3. PROLYTE ROOF AND OUTDOOR STRUCTURES

3.5 USE

Supervision during the event

Key aspects that should be considered in planning supervision during an event include the following:

- The safety coordinator should monitor the event and take action as necessary to make sure that demountable structures are used as planned and that safety is not compromised or jeopardized.
- Users should not be admitted to a demountable structure until the safety coordinator is satisfied that it has been properly erected and complies fully with the design criteria.
- No structural members forming any part of a temporary demountable structure should be removed during use.
- The number and distribution of users for which a structure has been designed should not be exceeded.
- Sufficient stewards should be appointed to each structure by the client to safeguard spectators.

Electrical installations and lightning protection

Electrical installations in temporary structures should be adequately earthed in accordance with normal standards. Consideration should be given to the degree of exposure and likely risk of strike by lightning and, where appropriate, the structure itself should be adequately bonded or earthed. Advice on earthing and lightning protection should be sought from an electrical engineer.

In ground-supported constructions the main grid is quite often isolated to the towers because of the use of plastic or rubber castors in sleeve blocks. Thus the main grid needs to be earthed separately.

3.6 GROUND AND SITE CONDITIONS

The allowable bearing pressure on the ground is the pressure that can safely be applied to the ground. The type and stability of subsoil are of significant importance to the allowable bearing pressure. Particular care should be taken for:

- Ground conditions after heavy rain.
- Frozen or dried out surfaces.
- Bituminous, concrete or similar hard standings, the thickness and type of underlying material are critical to the ability of the surface to support load.

Wood pads/spreaders

The normal method of supporting temporary demountable structures is to place timber spreaders on the ground and then use scaffolding screw jacks with soleplates to level up the structure. Special heavy-duty baseplates are sometimes used for temporary demountable structures; these are larger, stiffer and stronger than conventional scaffold.

Experience has shown that timber spreaders may be placed directly onto grassed surfaces underlain by ground of adequate bearing capacity. However, wherever structures are placed on grassed slopes, the turf/topsoil should be excavated locally to provide horizontal bearing beneath the spreader. Baseplates and spreaders should be engineered and their size and distribution not left to chance. Design calculations should be prepared to show how the leg loads are transferred to the ground. Experience has shown that the use of either scaffold boards or railway sleeper spreaders is generally satisfactory.

Concentrated soleplate/baseplate loads should be assumed to spread through the timber spreader at 2 horizontal to 1 vertical along the grain, and 1 to 1 across the grain unless directed otherwise by calculation. For heavy leg loads, the provision of a grillage of spreader timbers may be necessary. The contractor should inspect baseplates for damage before each use.

They should be positioned centrally under the load unless indicated otherwise in the design documentation. Failure to comply with this requirement may result in bearing stresses far in excess of calculated values, leading to local overstress of the ground and unacceptable differential settlement of the structure.

Ground anchors

Several types of proprietary ground anchor are available. Manufacturers of ground anchors usually provide data on safe working loads for various soil types. It should be noted that these allowable loads vary considerably. Ground anchors should be designed by a competent person and installed in accordance with the manufacturer's guidelines and recommendations. Ground anchors can be difficult to install accurately. This can lead to eccentricities and give rise to bending moments in the structure or in the foundations that need to be accounted for in the design.



Photo: XXL Roof, PROMontaje, Venezuela

Sloping ground

In general, it is not recommended to build temporary structures such as roof systems on uneven grounds due to the fact that this can cause massive erection difficulties as well as instabilities in the structure during erection and/or dismantling. Where a site slopes or is uneven, it will be necessary to either make the ground flat or to erect a structure that is capable of being modified to deal with the unevenness. Where the ground is not level or near level and the foundation bases for the structure cannot be set at an angle, a level base should be provided.

This may be done either by cutting steps into the ground or by laying timber sleepers up the slope with timber blocks, shaped to match the slope and fixed to the sleepers to form individual foundations for each upright. It should be noted that the bearing capacity of foundations on a step is reduced proportionate to the slope of the surrounding ground. This reduction should be accommodated in design. A competent person should furthermore check the stability of the sloping ground.

3.7 WIND CONDITIONS

The influence of wind on a temporary demountable structure is one of the greatest dangers. Therefore, it is of primary importance that all measures mentioned in the static report are applied. The non-skilled omission of ballast, guy-wires or other construction parts can have major consequences for the security of all people concerned.

When using a temporary demountable structure, consulting local bulletins and/or applicable websites on a daily basis and taking precautions if necessary is therefore recommended. It is permissible to reduce wind loadings on temporary demountable structures if canopies and scrims can be taken out within a certain time frame; 10 to 15 minutes seems to be adequate. In general, these precautions are taken from winds speeds above 20m/s / 74 km/h / 46mph. Wind speed should be measured at a height of 10m above ground level, or at least at the highest point of the structure.

Use of scrim

The use of permeable scrim for every outdoor structure needs special attention. Quite often, permeability is expressed in a percentage related to light transmission.

3. PROLYTE ROOF AND OUTDOOR STRUCTURES

It should be noted that this is not the same thing as wind permeability. Scrim should be supplied with a CF number (aerodynamic resistance) for permeability. The type of fabric, its structure and the size of the openings determine this factor. In practice this implies that scrim may look open but is not with regard to wind. Special acoustic scrims are available for sound wings. Most 'standard' scrims deform sound dramatically as they let the wind pass through.

3.8 SETUP, INSPECTION AND DISMANTLING

Preparation

The critical setup stages for temporary demountable structures should be identified during the design process. To ensure adequate provisions against overturning during erection, temporary strutting and/or guying may be necessary; such requirements should be adequately communicated to the site operatives.

Work site safety

The structure should be erected safely in accordance with the manuals and drawings provided. All Kent ledges, temporary guying and other means of temporary support identified in the manual should be properly installed to provide for the safety of operatives. All work at height must be fully assessed and carried out in compliance with the local or international requirements. Care should be taken to use the correct component in the correct location and orientation.

All components should be carefully aligned. They should not be bent, distorted or otherwise altered to force a fit. Particular attention should be paid to lightness of connections. The torque applied to bolts and other connectors should be in accordance with the manufacturer's recommendations. Care should be taken to ensure that all ties and bracings specified have been correctly installed. Site alterations or adaptations to the specified design should not be made without the designer's verification.

Guy-wires and connections

All necessary guy-wires and other components should be incorporated as assembly progresses. Guy-wires should be arranged to provide stability at all stages of

erection. A check should be carried out to ensure that the necessary connections are made and that linking components are not strained to achieve engagement. Local instability that might endanger the complete structure when loading occurs could arise through omitting or failing to tighten a bolt. Constant emphasis should be placed on the importance of paying attention to detail.

Safety of operatives

Following the guidelines for the safety of operatives involved in construction work is recommended. PPE, including fall arrest equipment, should be used where appropriate. Suitable anchorage points should be identified in the design.

Inspection of structures

Inspection is essential to maintaining the safety and integrity of a demountable structure. Inspections are required at various stages and are mainly the responsibility of the contractor. The client, safety coordinator and local authority may also make inspections. The contractor should make regular inspections during setup to verify the design assumptions and to check that work is being carried out in accordance with the documentation provided. The initial inspection should concentrate on setting out and site preparation. Subsequent inspections should check the orientation and location of the components, especially bracing members, the use of temporary supports and the proper installation of the correct connectors, couplers and fittings.

All inspection work should be documented. Specific reference should be made to remedial measures identified as being necessary and to dates agreed for carrying out such work. The contractor should carry out any remedial work deemed necessary by these inspections, unless he can provide documentary evidence to show that the as-built situation is safe.

Local authority

Where a local authority license is required, the local authority inspector should be provided with a full set of documents for the assembly of the temporary structure and may inspect it at any stage. Such inspection will pay particular attention to site preparation and the

fully assembled structure. The inspector may also require copies of any formal documentation of previous inspections.

Setup check

After setup, the structure should be subject to an erection check by a competent person. The inspection should be followed by a systematic local check of the complete structure. A drawing and checklist should be available for continuous reference. The inspection should check that:

- Setting out is accurate within the tolerance required.
- The foundations are adequate, that they are not likely to be disturbed and that they and the lower portion of the supporting structure are not liable to damage by interference, accident, traffic, scour, undermining or any other cause.
- Suitable baseplates/spreaders have been provided, properly levelled and, where necessary, adequately supported.
- The baseplates/spreaders have been properly bedded down, with no unacceptable settlement.
- Members are correctly positioned and connected.
- The stipulated limits of extension of adjustable components have not been exceeded.
- All required components, including pins, bolts, nuts, clips etc., are of the correct type, have been correctly inserted and are secure.
- Decking, seating and guardrails have been correctly installed and are secure.
- Services to the structure do not in themselves create a hazard or impose loadings not catered for in the design.
- On completion of a satisfactory inspection, the client should be informed and confirmation made in writing. After the structure is completed and inspected, it should be secured to prevent vandalism.

Measures should be taken to prevent unauthorized access beneath the temporary structure. It is recommended that a competent person inspect each structure while it is in use, with the frequency of inspections depending on the nature of the event. If a structure remains in use for a longer period of time (e.g. for a series of concerts at a festival), it should be inspected before each use.

Dismantling

The process of dismantling a demountable structure is important since its components are likely to be reused. Care should be taken to maintain the safety of the dismantling team and other people nearby.

Any temporary guying used to erect the structure will therefore be required when dismantling.

This should prevent components from being bent, distorted or overstressed during dismantling.

Minor damage to the structure may have occurred whilst in service, and damaged components should have been clearly marked in advance for ease of identification when dismantling.

During dismantling, the contractor should examine all components for signs of wear, deformation or other damage. Damaged components, or those with temporary repairs, should be set aside for rejection or permanent repair offsite.

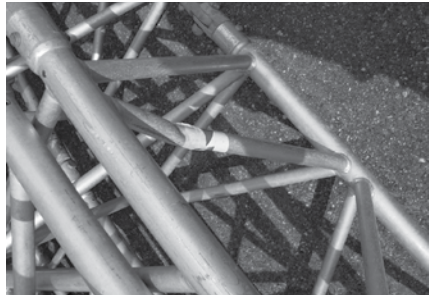

3. PROLYTE ROOF AND OUTDOOR STRUCTURES

Inspection of components

Repeated use of demountable structures will inevitably lead to general wear and tear on top of the damage or distortion that may occur during handling, transportation, assembly and dismantling. The contractor should regularly inspect all components used in demountable structures – including both erection aids and components of the structure itself – for signs of wear, deformation or other damage.

Such inspections should be carried out at the following stages:

- When allocated at the stockyard.
- On arrival onsite or during unloading.
- During assembly.
- Whilst in service.
- During dismantling.
- On arrival back at the stockyard.

Typical damage can include:

Tube and prefabricated components:

- Corrosion, cracking, deformation, creasing, split ends, non-flat or non-square ends, weld integrity.

Connectors, couplers, fittings:

- Deformation, distortion, damaged threads.

Please refer to specific rejection criteria for components supplied by the manufacturer.

3.9 IDENTIFICATION

Structure components

All Prolyte trusses, towers and components are individually marked and can be identified by a type shield. Make sure these stickers are on the product. Overview drawings show where each component goes in the built construction.

Canopies

Prolyte canopies are generally made from fire retardant PVC. Identification marks are stamped in the material and printed on the label. Certificates for different countries are available upon request.

3.10 ASSEMBLY

Canopy

Over-tensioning should be avoided as this reduces the lifespan of the canopy dramatically and can result in excessive stresses in the main grid trusses.

Ballast

Ballast is the additional weight that is necessary to keep the structure in place and to secure it against wind forces, wind gusts, sliding or other hazards. The required weight can be different for each tower. For a list of the total amount of ballast needed, see the structural report.

In view of the various methods for applying ballast, as well as local legal restrictions, specific weight types are not shown in the drawings. However, ballast weight on tower bases is essential to ensuring the stability and safety of the system, and particularly in limiting climatic (wind!) conditions.

The weight of an intermediate, interconnected construction or stage can be deducted from the total required ballast loading, provided the stage is capable of bearing the horizontal forces, as specified in the structural report. The stage must furthermore function as a single solid platform – meaning that the entire stage should come up when it is lifted at any corner. These requirements need to be checked by the stage supplier.

Lifting

The structural integrity of a temporary demountable structure is only guaranteed when completely built, meaning when all guy wires are in place and the ballast is connected. Integrity is not the same during lifting and lowering!

It is important to keep this in mind at all times. In general, Prolyte structures can be lifted and lowered at a maximum wind speed of 7.9 m/s (28.4 km/h / 17.6 mph).



When lifting the structure, one person should always be in charge of the lifting operation and one employee should monitor the lifting at each lifting point. Make sure there is good visibility at all times.

Ensure that the capacity of your lifting device is adequate. We advise having at least 25% headroom in capacity. Unequal lifting, friction caused by sleeve blocks and uneven weight distribution can result in loads that are higher than foreseen.

Use of winches/hoist

Make sure to guide the wire-rope of the winch into neat side-by-side turns in smooth layers on the drum, as crossing cable turns cause severe damage and wear. Damage to wire ropes can lead to the breaking of wires, wire strands or even the whole cable, thus causing the sleeve block to fall, with a risk of property damage, personal injuries or even death.

When using a chain hoist, make sure that chains are free from twists at all times. Please make sure all points are lifted evenly and at the same speed. Intermediate checks or stops might be necessary to prevent uneven lifting of the complete structure.

3.11 INSPECTION

General

Prolyte encourages the performance of carefully documented inspections by a competent person at least once a year, and more often if the circumstances or intensity of use require this. Responsibility and liability for the safe use of all temporary demountable structures lies predominantly with the client itself!

Inspection levels

Both new and used truss modules should be inspected upon acquisition (initial inspections). Regular visual inspections should be carried out and a record of these inspections maintained. In addition, periodic inspections should be performed by a competent person prior to each use and at least once a year, or in accordance with an inspection routine established by a qualified person. Trusses subject to accident damage should be inspected in line with the requirements of periodic inspections.

Permanent installations

Periodic inspections should be carried out on all truss modules that are permanently installed in a stationary (not subject to movement) configuration. The frequency of inspections should be determined based on the existing conditions. In the case of truss modules installed in a permanent configuration where movement of the truss system is an integral part of use, periodic inspections should take place every three months, or in accordance with an inspection routine established by a qualified person.

Records

The owner should keep records of initial inspections and periodic inspections of each truss module, which should be signed and dated by the inspector.

Repairs and removal from service

If any part of a truss shows significant visible damage or is suspected to contain a damaged element (visible or not), the truss should be removed from service and marked accordingly. A qualified person should carry out an assessment of the truss. Any module that contains damage deemed irreparable should be permanently removed from use. Repairs should be carried out and warranted by either the manufacturer or a qualified person.

Steel wires and chains

Inspection criteria and maintenance instructions for hoists, winches and all other rigging equipment are provided in the relevant manuals.

Performer flying



Photo: Space Roof, Interstage, Concert at Sea, Netherlands

4. PERFORMER FLYING



Moving people vertically is generally done with lifts, escalators, work lifts and hoisting platforms. The first two transport facilities are oriented towards the requirements for large machines that are open for general public access.

The last two facilities can be classified as working equipment for a select group of persons who have been instructed. Both types are regulated by a series of safety requirements and regulations which are clearly defined by law.

However, if the creative use of the flying movement of a person is in question, there is scarcely a country on earth that has a legally correct and clearly defined regulation. For such special effects (used in film, TV and theatre) special people flying systems were developed for events technology. Despite this fact, this manner of transporting persons is excluded from the Machinery Directive (2006/42/EG).

In the case of persons being lifted by devices that were not originally intended for this purpose, the requirements of the Machinery Directive are quite clear: double the safety factor. Generally this means raising the safety factor from 5 to 10 or reducing the nominal load (WLL) x 0,5.

This proof can be provided by a manufacturer, for example, by a sort of design test by the TÜV and the subsequent identification of the trusses.

Prolyte has design tests for all truss types. Very detailed and specialised knowledge is required for flying performers. We strongly recommend engaging only companies which specialise in these types of projects.

Furthermore a technician should test thoroughly all components of a flying system and document the results of these tests. Before taking such a system into operation, an overload test and acceptance test should be performed. A risk assesment evaluation must be performed and the hazards for persons documented and measures to prevent this given. Furthermore, a practicable emergency plan must be drawn up, e.g. in case of a power cut.

We strongly recommend the Dutch code of practice NPR 8020-11 'Manual Driven Performer' Flying'systems'

SAFETY FACTOR	STATIC LOAD NO PERSONS UNDER LOAD	STATIC LOAD PERSONS UNDER LOAD	DYNAMIC LOAD PERSONS UNDER LOAD	STATIC LOAD PERSONS ON OR ATTACHED TO LOAD (A)	DYNAMIC LOAD PERSONS ON OR ATTACHED TO LOAD (C)
NOMINAL LOAD	✓				
0,5 X NOMINAL LOAD OR EQUIVALENT SECONDARY SUSPENSION		✓	✓	✓(b)	✓

A) Examples: Focussing lights from the truss, the use of follow spot chairs or platforms for technical equipment.

B) Persons on the load need to take precautions against the risks of falls from height.

NB: The consequences for the static loading, as a result of climbing the construction or the absorption of forces resulting from fall arrest equipment need to be taken into account (EN 795)

C) Examples are: ballet, presentation on a lifting platform, installations for Performer Flying, work platforms

Personal safety equipment in the entertainment industry



Photo: Mammoth Ground Support, NeuroTech, China

5. PERSONAL SAFETY EQUIPMENT IN THE ENTERTAINMENT INDUSTRY

In a working environment employees are obligated to wear Personal Safety Equipment (PSE). It's a misconception that only the persons who are working at height or working in a riskful environment must use PSE. All personnel entering a working site must use PSE. This could consist of shoes with rubber soles and steel noses or hard heads. In many building sites it's obligatory to wear a yellow jacket, which is designed to attract more attention to the other people who are working on the building site. Recommended PSE items are gloves, shoes with steel noses, a yellow jacket and a heard head.

The responsibility of the employer is to make sure all PSE items are available on site for every employee, and to check whether the employees wear and use this PSE. It is the responsibility of the employee to take as little risk as possible during his work. For example, never stand underneath a roofing system or a load while these are lifted.

All the PSE are regulated according to the European Health and Safety Directive. Besides this European Health and Safety Directive there are many other regulations on Personal Safety Equipment, and each different regulation has its own role in the total working environment. Many of these regulations are locally imposed, which makes it quite impossible to mention all regulations. The most common regulations are listed below.

Working at height

Working at height (over 2,5 m.) is very common in the entertainment industry, for example to focus luminaires or replace a broken bulb. In the case of working at height, always attempt to undertake work without climbing, and attempt to obtain access to the working area using working platforms to decrease the risk this work involves.

Sometimes climbing is inevitable in order to get access to a certain point in the roof or building structure. In which case always undertake your own risk assessment and try to find a solution involving as little risk as possible.

Climbing gear

General regulations state that from a working height of 2,5 meter, the employee has to wear proper PSE, including a full body harness. Employers are obliged to provide appropriate PSE for their employees. Freelance personnel should provide their own PSE.

For riggers and climbing technicians, the most important items of their PSE are: a full body harness in combination with a shock absorber and a fall arrest system. There are many types of harnesses on the market. For riggers and climbing technicians a full body harness, consisting of a full body harness and a seat harness, is recommended.

The two parts of the harness are attached and thus designed to spread the forces of the fall over your entire body. Suspension position after a fall is calculated to maximise the chance of surviving. In combination with a full body harness riggers should also use a fall arrest system. The fall arrest system should be attached either to your front (chest) or back (shoulder blades) suspension point. The additional shock absorber should always be attached above the waist.

We recommend that the fall arrest system be attached to a lifeline system, which is attached to a building or roof structure at any time. Attaching your fall arrest system to the truss can be a dangerous option, as most trusses are not designed to withstand the additional forces of a free fall.

Fall arrest system with shock absorber

An essential part of the fall arrest system is the shock absorber. This shock absorber is designed to reduce the force of a fall to a maximum of 600 kg. Without the use of a shock absorber, the force caused by a free fall can easily increase to 25 times the self-weight of the person who is falling, depending on the length of the fall and the attachment to the structure. (fall speed = 9,8 m/s²)

Any elastic movement in the suspension rope or the construction might reduce these rates, but only very limited compared to a shock absorber. The possibility of surviving a fall without a full body harness and a fall arrest system is very low. Any full body harness must

5. PERSONAL SAFETY EQUIPMENT IN THE ENTERTAINMENT INDUSTRY

comply with the EN 361 'personal safety equipment against falling'. The shock absorber should comply with Standard EN 355.

Positioning equipment

Next to the fall arrest system the use of positioning equipment is also recommended. Positioning equipment normally consists of a rope or sling together combined with special climbing gear like carabiners or saflock (scaffold) hooks. The positioning equipment should always be attached to the ring on the seat harness and is mainly used to place yourself in a working position, without using your hands. When the positioning equipment leaves room for a fall of over 0.5 meter you are obliged to attach the fall arrest system/ shock absorber.

We recommend leaving the fall arrest system always attached to the lifeline or roof system, this will reduce the risk of failing positioning equipment. The anchor point should never be below the waist of the person who is climbing, in order to keep the falling distance as short as possible. When this anchor point is attached to the truss this anchor point should always be on the main chord and in a node point. The use of two separate anchor points leaves you always attached to the structure, even when you are changing the position of one of the scaffolding hooks.

Hardhat policy

The use of hard hats is obligatory on many construction sites, as well as for climbing personnel. Hard hats should comply with EN 397 standards. Hard hats protect the head from injury by falling objects and impact with other objects during climbing or in case of a fall. Hard hats require a restrained strap cradle to prevent the helmet from being displaced during a fall.

Climbing a truss structure

One of the most common misconceptions about climbing Prolyte trusses is that the MPT truss series are not suitable for climbing but the heavy-duty series are. It is important to be aware that in the majority of cases neither truss is capable of withstanding the forces of a free fall.

We advise you to suspend your lifeline system from the roof or additional structure and never from the truss grid itself, wherever possible. Whenever you are intending to climb the truss rig, the weight of the technician must be included in the calculation of the system. This is not only the weight of the person itself, but also the reaction forces of an eventual fall, which is 600 kg. in the worst possible position - usually the middle of a free span.

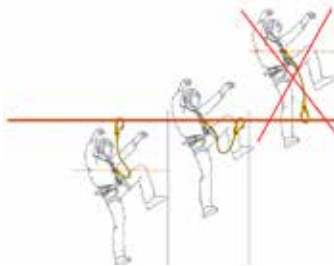

Fall arrest system with shock absorber



Shock absorbing Lanyard



Example:

For a single span supported on two hoists you need to determine if the truss span is capable of withstanding the reaction forces from the equipment suspended from the truss, plus the additional 600 kg, resulting from a free fall (calculated as point load). Also the hoists should be able to take the resulting 600kg extra loading. Which is the case if you fall directly underneath a suspension point

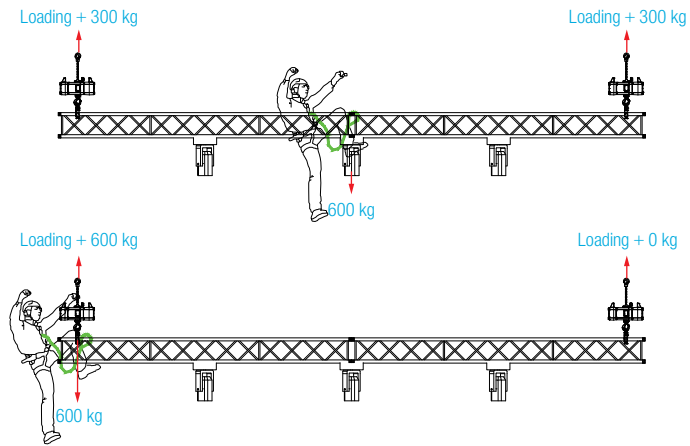

Regulations

Most common regulations are listed here.

EN 361: 2002	Personal protective equipment against falls from a height - Full body harnesses.
EN 358: 2000	Personal protective equipment for work positioning and prevention of falls from a height - Belts for work positioning and restraint and work positioning lanyards.
EN 354:2008 2nd draft en	Personal protective equipment against falls from a height - Lanyards.
EN 355:2002 en	Personal protective equipment against falls from a height - Energy absorbers.
EN 813:2005 2nd draft en	Personal fall protection equipment - Sit harnesses.
EN 360:2002 en	Personal protective equipment against falls from a height - Retractable type fall arresters.
EN 363:2008 en	Personal fall protection equipment - Personal fall protection systems.
EN 795:2003 draft en	Protection against falls from a height - Anchor devices - Requirements and testing.
EN 1868:2003 draft en	Personal fall protection equipment - Definitions and list of equivalent terms.

- Draft versions are replacing earlier standards.

Forces acting on the truss



Environmental influences, rain loads



Rules for application



We would like to provide some tips for using trusses in daily operation:

Data acquisition

Loads to be applied:

- Number of the different single and span loads such as: floodlamps, moving lights, power supply units, follow spots (including seat and operator), cables, adapters, loudspeakers, loudspeaker cradles, projection screens, projectors, flying frames, curtains, backdrops, etc.).
- Mass/weight of the individual loads.
- Determination of the overall load.
- Number and type of supports.
- Number and distance of the flying points and their load-bearing capacity.
- Number and distance of columns and/or rigging points.

Local circumstances:

- Access to the site.
- Potential equalisation.
- Communication paths with event organisers and authorities.
- Special local regulations (e.g. prohibition of special working materials).

Selection of suitable trusses

Firstly the load for every individual truss span must be calculated. If a combination of uniformly distributed load and point loads occurs on a truss, the corresponding formulae should be used. The values for uniformly distributed loads and point loads should not simply be added together. The bending moments are highly dependent on the positioning of the loads.

NB: uniformly distributed lighting fixtures on trusses can be regarded more or less as uniform loads with the exception of follow spots lamps which have to be treated as point loads. The loads are compared with the allowable values according to the load tables for the corresponding truss types (the allowable structural data like bending moments can be found in the catalogues). As the next step the self weight of the truss type for this application is determined.

The overall weight can be calculated from the length of the truss (including all connecting parts). The overall weight is needed later to determine the reaction forces

at the supports.

Multiple supports

Firstly it should be determined how many supports will be needed to ensure adequate safety of the truss span if either the load is so high that the allowable bending moment is exceeded or a span with two supports exceeds the values in the table.

The reaction forces are calculated from the self weight of the truss and the loads imposed. The corresponding formulae for trusses on two supports or for trusses on more than two supports (multi-span trusses) should be used. Next the required bearing capacity of the lifting equipment based on the reaction forces is calculated. If loads are suspended over persons, suitable methods must be found to ensure that the failure of an overhead suspension does not place that person at risk (single failure tolerance). This shall be documented by a risk assessment.

The reaction forces

The loads on the main structure are calculated as follows: For 'flying' trusses: Add the self weight of the lifting equipment to the calculated reaction force, calculate the length of the steels (and from that the mass which is also added to the reaction force) as well as the horizontal forces in the rigging points caused by possible brides.

For free-standing truss structures (ground support): Add the self weight of the vertical columns to the calculated reaction force and check the allowable effective length of the vertical supports. In addition the whole truss structure should be checked with regard to overall safety and stability. If needed, the appropriate braces or guy wires must be added.

Checking the point loads of the rigging points in buildings: For 'flying' trusses: Check truss joints, spans and corresponding rigging points for their bearing capacity. The data regarding the allowable joist and node point loads must be supplied by the operator of the event site.

For free-standing structures (ground support): allow for the bearing capacity of the floor area. The base of a truss is generally much less than a square metre, despite the baseplate. The information on the allowable floor



loading must be provided by the operator of the site. The rigger will perform the necessary corrections to prevent potential overload situations by modifying the position and number of the hoist devices or placing bridles.

Diagrams and tables

All collated information and calculations must be recorded in written form so that they can be checked by structural engineers or authorities. Diagrams should show the position and identification of the suspension points and hoisting gear with the corresponding point load including the weight of the hoisting gear in kg or kN. Furthermore the diagrams must be to scale which must be given in the diagram.

The diagrams must also contain the allowable loads for the slinging points and the vertical slinging wires and bridles. Tables must contain all hoisting devices, all point loads, all slinging points and all vertical loads at the individual slinging points. The numerical values can be rounded up to the nearest 5 or 10 kg in order to allow for the weight of the slinging devices, shackles, rings, span clamps etc. that are not specified with all their details in the original weight lists.

Keep your knowledge up-to-date

In writing and compiling this BlackBook, Prolyte has tried to offer a complete and up-to-date overview of current regulations and standards, however we can never guarantee that we can publish the latest developments directly. Therefore it's always good to keep your knowledge fresh by staying in the loop of new developments and regulations by reading the multitude of articles, books and blogs that do appear regularly.

Furthermore you can attend Prolyte Campus events, that are organized on a regular basis all around the globe. Prolyte Campus events aim to bring vital knowledge on trussing, staging and rigging to a wider audience to help you build things better and safer. Have a look at our website prolyte.com, when and where you may be able to join the next campus event.

Prolyte produces technical blogs, instruction videos and relevant information on a regular basis, or you can post your questions on our forum. Stay tuned on www.prolyte.com



Photo: Aku's Factory, Finland

PROLYTE CAMPUS: A LEARNING INITIATIVE

Prolyte Campus is a Prolyte initiative to support customers with the best and most up-to-date knowledge available. Providing the tools and training to use Prolyte products safely and in compliance with applicable standards and regulations will help you perform better. Prolyte Campus offers a complete program of learning activities to create awareness on the safe use of Prolyte products.

Providing the knowledge to let your business grow

As a manufacturer Prolyte feels responsible to provide knowledge as an integrated part of their products. Creating the awareness that safe working practices are key to responsible ownership, is one of our goals. Placing all our training initiatives under one umbrella is a means to facilitate access to this knowledge base for all our customers and users. Transferring knowledge and creating a dialogue with technicians worldwide, finding their needs and sharing experiences is a valuable base for creating solutions that work and help you grow your business.

What does the Prolyte Campus offer?

Sharing knowledge is the pivotal point, in whatever way is needed to get the message across. Prolyte Campus offers a mix of online, printed and seminar based means of knowledge transfer. Existing activities like the BlackBook, how-to videos, rigging courses and seminar opportunities, will be continued. New initiatives like web based learning content and networking opportunities will be developed. Prolyte users will be encouraged to share their experience and daily practice skills.

Enroll in the Prolyte Campus

Want to join this initiative? Share your ideas or experience on www.prolyte.com/prolytecampus participate in one of our seminar programs or organize one! You can find more info at www.prolyte.com/prolytecampus or contact marketing@prolyte.com for any specific requests.



PROLYTE
CAMPUS

