

# IN1606

# IN1608

# IN1608 SA

# IN1608 MA

Scaling Presentation Switchers



**Extron Electronics**  
INTERFACING, SWITCHING AND CONTROL

## Safety Instructions • English

**WARNING:** This symbol, ⚠, when used on the product, is intended to alert the user of the presence of uninsulated dangerous voltage within the product's enclosure that may present a risk of electric shock.

**ATTENTION:** This symbol, ⚠, when used on the product, is intended to alert the user of important operating and maintenance (servicing) instructions in the literature provided with the equipment.

For information on safety guidelines, regulatory compliances, EMI/EMF compatibility, accessibility, and related topics, see the Extron Safety and Regulatory Compliance Guide, part number 68-290-01, on the Extron website, [www.extron.com](http://www.extron.com).

## Instructions de sécurité • Français

**AVERTISSEMENT:** Ce pictogramme, ⚠, lorsqu'il est utilisé sur le produit, signale à l'utilisateur la présence à l'intérieur du boîtier du produit d'une tension électrique dangereuse susceptible de provoquer un choc électrique.

**ATTENTION:** Ce pictogramme, ⚠, lorsqu'il est utilisé sur le produit, signale à l'utilisateur des instructions d'utilisation ou de maintenance importantes qui se trouvent dans la documentation fournie avec le matériel.

Pour en savoir plus sur les règles de sécurité, la conformité à la réglementation, la compatibilité EMI/EMF, l'accessibilité, et autres sujets connexes, lisez les informations de sécurité et de conformité Extron, réf. 68-290-01, sur le site Extron, [www.extron.fr](http://www.extron.fr).

## Sicherheitsanweisungen • Deutsch

**WARNUNG:** Dieses Symbol ⚠ auf dem Produkt soll den Benutzer darauf aufmerksam machen, dass im Inneren des Gehäuses dieses Produktes gefährliche Spannungen herrschen, die nicht isoliert sind und die einen elektrischen Schlag verursachen können.

**VORSICHT:** Dieses Symbol ⚠ auf dem Produkt soll dem Benutzer in der im Lieferumfang enthaltenen Dokumentation besonders wichtige Hinweise zur Bedienung und Wartung (Instandhaltung) geben.

Weitere Informationen über die Sicherheitsrichtlinien, Produkthandhabung, EMI/EMF-Kompatibilität, Zugänglichkeit und verwandte Themen finden Sie in den Extron-Richtlinien für Sicherheit und Handhabung (Artikelnummer 68-290-01) auf der Extron-Website, [www.extron.de](http://www.extron.de).

## Instrucciones de seguridad • Español

**ADVERTENCIA:** Este símbolo, ⚠, cuando se utiliza en el producto, avisa al usuario de la presencia de voltaje peligroso sin aislar dentro del producto, lo que puede representar un riesgo de descarga eléctrica.

**ATENCIÓN:** Este símbolo, ⚠, cuando se utiliza en el producto, avisa al usuario de la presencia de importantes instrucciones de uso y mantenimiento recogidas en la documentación proporcionada con el equipo.

Para obtener información sobre directrices de seguridad, cumplimiento de normativas, compatibilidad electromagnética, accesibilidad y temas relacionados, consulte la Guía de cumplimiento de normativas y seguridad de Extron, referencia 68-290-01, en el sitio Web de Extron, [www.extron.es](http://www.extron.es).

## Chinese Simplified (简体中文)

**警告:** ⚠ 产品上的这个标志意在警告用户该产品机壳内有暴露的危险电压, 有触电危险。

**注意:** ⚠ 产品上的这个标志意在提示用户设备随附的用户手册中有重要的操作和维护(维修)说明。

关于我们产品的安全指南、遵循的规范、EMI/EMF 的兼容性、无障使用的特性等相关内容, 敬请访问 Extron 网站 [www.extron.cn](http://www.extron.cn), 参见 Extron 安全规范指南, 产品编号 68-290-01。

## Chinese Traditional (繁體中文)

**警告:** ⚠ 若產品上使用此符號, 是為了提醒使用者, 產品機殼內存在著可能會導致觸電之風險的未絕緣危險電壓。

**注意:** ⚠ 若產品上使用此符號, 是為了提醒使用者。

有關安全性指導方針、法規遵守、EMI/EMF 相容性、存取範圍和相關主題的詳細資訊, 請瀏覽 Extron 網站: [www.extron.cn](http://www.extron.cn), 然後參閱《Extron 安全性與法規遵守手冊》, 準則編號 68-290-01。

## Japanese

**警告:** この記号 ⚠ が製品上に表示されている場合は、筐体内に絶緣されていぬ高電圧が流れ、感電の危険があることを示しています。

**注意:** この記号 ⚠ が製品上に表示されている場合は、本機の取扱説明書に記載されている重要な操作と保守(整備)の指示についてユーザーの注意を喚起するものです。

安全上のご注意、法規遵守、EMI/EMF適合性、その他の関連項目については、エクストロンのウェブサイト[www.extron.jp](http://www.extron.jp)より『Extron Safety and Regulatory Compliance Guide』(P/N 68-290-01)をご覧ください。

## Korean

**경고:** 이 기호 ⚠, 가 제품에 사용될 경우, 제품의 인클로저 내에 있는 접지되지 않은 위험한 전류로 인해 사용자가 감전될 위험이 있음을 경고합니다.

**주의:** 이 기호 ⚠, 가 제품에 사용될 경우, 장비와 함께 제공된 책자에 나와 있는 주요 운영 및 유지보수(정비) 지침을 경고합니다.

안전 가이드라인, 규제 준수, EMI/EMF 호환성, 접근성, 그리고 관련 항목에 대한 자세한 내용은 Extron 웹 사이트([www.extron.com](http://www.extron.com))의 Extron 안전 및 규제 준수 안내서, 68-290-01 조항을 참조하십시오.

## FCC Class A Notice

This equipment has been tested and found to comply with the limits for a Class A digital device, pursuant to part 15 of the FCC rules. The Class A limits provide reasonable protection against harmful interference when the equipment is operated in a commercial environment. This equipment generates, uses, and can radiate radio frequency energy and, if not installed and used in accordance with the instruction manual, may cause harmful interference to radio communications. Operation of this equipment in a residential area is likely to cause interference; the user must correct the interference at his own expense.

**ATTENTION:** The Twisted Pair Extension technology works with unshielded twisted pair (UTP) or shielded twisted pair (STP) cables; but, to ensure FCC Class A and CE compliance, STP cables and STP connectors are required.

For more information on safety guidelines, regulatory compliances, EMI/EMF compatibility, accessibility, and related topics, see the “[Extron Safety and Regulatory Compliance Guide](#)” on the Extron website.

### Copyright

© 2013 Extron Electronics. All rights reserved.

### Trademarks

All trademarks mentioned in this guide are the properties of their respective owners.

**The following registered trademarks<sup>®</sup>, registered service marks<sup>SM</sup>, and trademarks<sup>TM</sup> are the property of RGB Systems, Inc. or Extron Electronics:**

Registered Trademarks <sup>®</sup>
AVTrac, Cable Cubby, CrossPoint, eBUS, EDID Manager, EDID Minder, Extron, Flat Field, GlobalViewer, Hideaway, Inline, IP Intercom, IP Link, Key Minder, LockIt, MediaLink, PoleVault, PowerCage, PURE3, Quantum, SoundField, SpeedMount, SpeedSwitch, System Integrator, TeamWork, TouchLink, V-Lock, VersaTools, VN-Matrix, VoiceLift, WallVault, WindoWall
<b>Registered Service Mark<sup>SM</sup> :</b> S3 Service Support Solutions
Trademarks <sup>TM</sup>
AAP, AFL (Accu-Rate Frame Lock), ADSP (Advanced Digital Sync Processing), AIS (Advanced Instruction Set), Auto-Image, CDRS (Class D Ripple Suppression), DDSP (Digital Display Sync Processing), DMI (Dynamic Motion Interpolation), Driver Configurator, DSP Configurator, DSVP (Digital Sync Validation Processing), FastBite, FOXBOX, IP Intercom HelpDesk, MAAP, MicroDigital, ProDSP, QS-FPC (QuickSwitch Front Panel Controller), Scope-Trigger, SIS, Simple Instruction Set, Skew-Free, SpeedNav, Triple-Action Switching, XTP, XTP Systems, XTRA, ZipCaddy, ZipClip

# Conventions Used in this Guide

## Notifications

The following notifications are used in this guide:

**ATTENTION:** Attention indicates a situation that may damage or destroy the product or associated equipment.

**NOTE:** A note draws attention to important information.

**TIP:** A tip provides a suggestion to make working with the application easier.

## Software Commands

Commands are written in the fonts shown here:

```
^ARMerge Scene , ,Op1 scene 1,1 ^B 51 ^W ^C  
[ 01 ] R 0004 00300 00400 00800 00600 [ 02 ] 35 [ 17 ] [ 03 ]
```

```
Esc [X1] * [X17] * [X20] * [X23] * [X21] CE ←
```

**NOTE:** For commands and examples of computer or device responses mentioned in this guide, the character “Ø” is used for the number zero and “o” represents the capital letter “o.”

Computer responses and directory paths that do not have variables are written in the font shown here:

```
Reply from 208.132.180.48: bytes=32 times=2ms TTL=32  
C:\Program Files\Extron
```

Variables are written in slanted form as shown here:

```
ping xxx.xxx.xxx.xxx -t  
SOH R Data STX Command ETB ETX
```

Selectable items, such as menu names, menu options, buttons, tabs, and field names are written in the font shown here:

```
From the File menu, select New.  
Click the OK button.
```

## Specifications Availability

Product specification are available on the Extron website, [www.extron.com](http://www.extron.com).

# Contents

---

## **Introduction ..... 1**

IN1606 and IN1608 Series Description .....	1
Licensed Third-Party Software Used in the Scalers .....	4
Key Features .....	5
Video .....	5
Audio .....	5
General .....	6
Controlling the Scalers .....	7

---

## **Installation ..... 8**

Rear Panel Connections .....	8
Connection Details .....	12
Analog Video Wiring .....	12
HDMI Connections .....	12
Twisted Pair Recommendations for DTP Communication .....	13

---

## **Operation ..... 14**

Front Panel Overview .....	14
Powering Up .....	15
Input Selection .....	15
On-Screen Display (OSD) Menu System .....	15
Menu Navigation Using Front Panel Controls .....	15
Menu Overview .....	16
Quick Setup Submenu .....	17
User Presets Submenu .....	18
Picture Controls Submenu .....	19
Input Submenu .....	20
Output Submenu .....	21
Audio Submenu .....	23
Advanced Submenu .....	24
Communication Submenu .....	26
Device Info Submenu .....	27
Front Panel Lockout (Executive Modes) .....	27
Reset Modes .....	28

---

## **SIS Configuration and Control ..... 29**

Host and Scaler Communication .....	29
Scaler-Initiated Messages .....	29
Copyright Information .....	29
Password Information .....	30
Error Responses .....	30
SIS Overview .....	31
Using the Command and Response Tables .....	31
Symbol Definitions .....	31
Command and Response Tables .....	35
Input Switching Commands .....	35
Input Configuration Commands .....	36
Picture Adjustment Commands .....	39
Output Configuration Commands .....	41
Audio Configuration Commands .....	42
Preset Commands .....	44
Advanced Configuration Commands .....	45
Device Commands .....	47
IP Control Port Commands .....	49

---

## **Configuration Software ..... 50**

Installing the Software .....	50
Starting the Software .....	51
Connect to Online Device Tab .....	51
Start New Device File Tab .....	51
Using the Software .....	52
Connections Menu .....	52
Tools Menu .....	54

---

**Internal Web Pages..... 56**

Accessing the Internal Web Pages.....	56
Turning Off Compatibility Mode.....	56
Navigating the Internal Web Pages .....	57
AV Controls Panel.....	57
Configuration Pages .....	59
Input and Output Configuration Page.....	59
EDID Minder Page .....	61
Image Settings Page.....	63
Size and Position Page .....	67
Audio Config Page.....	68
Preset Management Page .....	76
Device Settings Page.....	77
Hardware Pages.....	78
Unit Information Page .....	78
Device Name Page .....	79
Communication Settings Page.....	80
Firmware Loader Page.....	81
Executive/Power Mode Page.....	82
Date and Time Page.....	83
Password Page .....	84
Reset Device Page .....	85

---

**Reference Information ..... 86**

Mounting .....	86
Tabletop Mounting.....	86
Rack Mounting .....	86
Furniture Mounting.....	87
Downloading Updated Firmware.....	88

# Introduction

This guide contains information about the Extron IN1606, IN1608, IN1608 SA, and IN1608 MA Scaling Presentation Switchers with instructions for experienced installers on how to install, configure, and operate the equipment. Topics in this section include:

- **IN1606 and IN1608 Series Description**
- **Licensed Third-Party Software Used in the Scalers**
- **Key Features**
- **Controlling the Scalers**

In this guide, the terms “IN1606,” “IN1608,” “IN1608 SA,” and “IN1608 MA” refer to their respective IN1606 or IN1608 Scaler Presentation Switcher model. The term “scaler” is used interchangeably to refer to all IN1606 and IN1608 models.

## IN1606 and IN1608 Series Description

The Extron IN1606 is a six input, HDCP-compliant video scaler in a 1U, full rack width enclosure. The IN1608 series includes the IN1608, IN1608 SA, and IN1608 MA. They are eight input, HDCP-compliant video scalers in a 1U or 2U, full rack width enclosures.

The scalers include four HDMI inputs, two configurable analog video inputs, and two simultaneous HDMI outputs. The IN1608 models also include two DTP 230 inputs and one DTP 230 output with corresponding RS-232 and IR pass-through ports. The IN1608 SA and IN1608 MA include a stereo or mono amplifier output.

They accept a wide variety of video formats including HDMI, HDTV, RGB, and standard definition video. They feature an advanced video scaling engine with 1080i deinterlacing and seamless switching to deliver uncompromised picture quality for up to 1920x1200, including 1080p and 2K output resolutions. Automatic 3:2 and 2:2 pulldown detection maximizes the image detail and sharpness for content sources originating from film. The scalers also use a digital 3D adaptive comb filter that optimizes decoding of NTSC, PAL, and SECAM sources for integration into systems worldwide. Enhanced audio features include analog stereo inputs, fixed and variable stereo outputs, two mic/line inputs with ducking and phantom power, plus HDMI audio embedding and de-embedding. Designed for professional AV integration, the scalers offer flexible control options including Ethernet, RS-232, and USB. They provide two simultaneous HDMI outputs so that two displays can be driven simultaneously, without the need for additional equipment.

To accommodate a variety of sources, the scalers feature four HDMI inputs plus two universal analog video inputs that can process RGB computer video, HDTV, component video, S-video, and composite video. They provide the capability to integrate digital and analog devices, with HDCP-compliance to enable integration of Blu-ray Disc players and cable or satellite HD receivers.

To enhance and simplify integration of HDMI sources and displays, the scalers feature two exclusive Extron technologies: EDID Minder and Key Minder. EDID Minder manages EDID communication between the display devices and input sources. For HDMI signals with protected content, Key Minder authenticates and maintains continuous HDCP-encryption between input and output devices. The scalers also feature SpeedSwitch technology that delivers exceptional switching speed for HDCP-encrypted content.

The scalers provide complete control of advanced audio configuration settings through internal Web pages. Using the internal Web pages, users can easily adjust audio input and output gain, attenuation, mixing, and ducking parameters.

The two DTP 230 twisted pair inputs and output on the IN1608 models receive and transmit signals from remote DTP 230 transmitters and a receiver. The DTP 230 twisted pair inputs and output include additional convenient, integrator-friendly features designed to help simplify installation. Bidirectional RS-232 and IR signals can be inserted from a control system and transmitted over the single CATx cable together with the video and audio, enabling control of a source or display. Additionally, IN1608 models can send power to each of the DTP 230 transmitters and receiver over the same CATx cable, streamlining system design and installation.

The scalers feature front panel controls with an on-screen display (OSD) menu system for quick access to functions. Remote configuration and control are available via USB, RS-232, and Ethernet. Housed in 1U or 2U, full rack width metal enclosures, the scalers can easily be integrated into many environments. They are ideal in boardrooms where superior performance is essential and instructional environments for complete integration of digital and analog AV sources and displays.

The following diagram demonstrates an example of a typical application for the IN1606 with multiple sources and outputs.

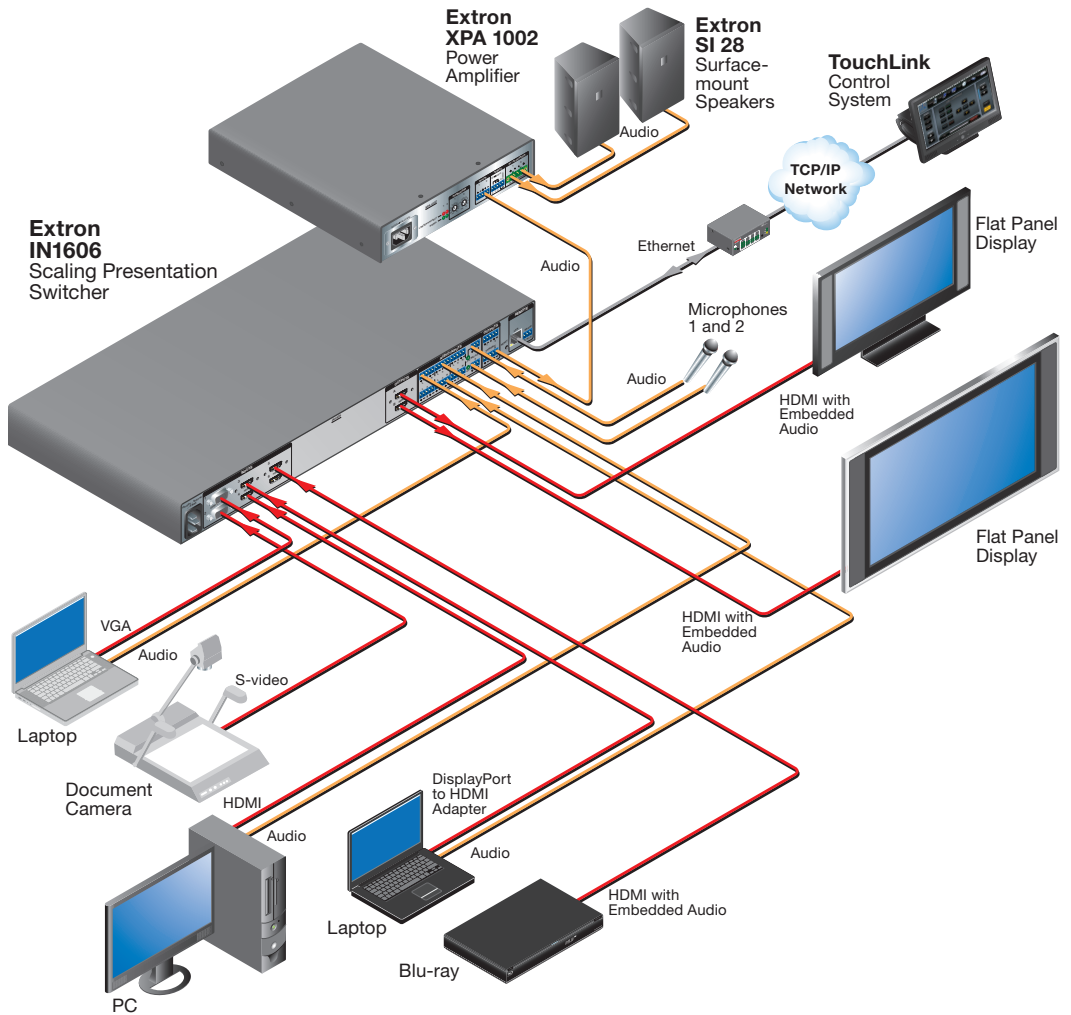

**Figure 1. Typical IN1606 Application**



The following diagram demonstrates an example of a typical application for the IN1608 SA with multiple sources and outputs.

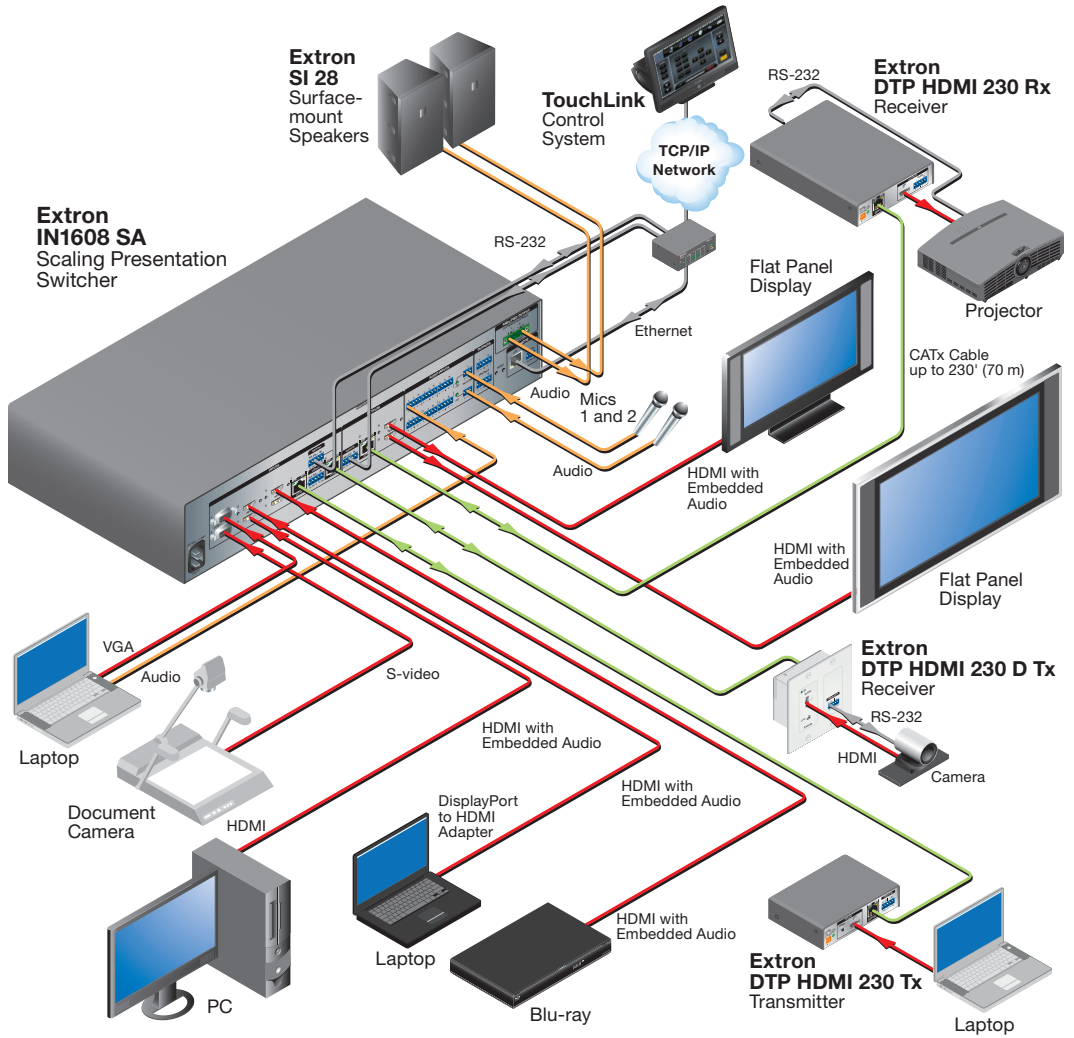

**Figure 2.** Typical IN1608 SA Application

## Licensed Third-Party Software Used in the Scalars

The scalars use various licensed third-party software during operation. To view details about third-party packages and associated licensing, click the **License Information** button on the Unit Information page of the internal Web pages (see [Unit Information Page](#) on page 78).

To view a copy of a listed package license, in the License Information window, click the link in the License column for the relevant package. This opens in a separate window a copy of the package license.

The following table lists the licensed third-party software used by the scalars.

**NOTE:** Licensed third-party software used by the scalars are subject to change without notice.

Licensed Third-party Software Used in the IN1606 and IN1608 Models			
Package	License	Package	License
avahi	GNU LGPL v2.1	lighttpd	BSD
bstrib	BSD	Linux	GNU GPL v2
busybox	GNUPGL v2	lua	MIT
bzip2	BSD	lua-cjson	MIT
cjson	MIT	luafilesystem	MIT
expat	MIT	luasocket	MIT
ExtJS4	Sencha Commercial License	luastruct	MIT
fcgi	fcgi	mttd	GNU GPL v2
freetype	Free Type License	ncurses	MIT
gnupg-1.4.7	GNU LGPL v2	openssh	BSD
gpgme	GNU LGPL	openssl	OpenSSL
ifplugd	GNU GPL	PAM	BSD
jpeg	libjpeg	pcre	BSD
libassuan	GNU LGPL	psmisc	GNU GPL v2
libcgicc 3.2.3	GNU LGPL v2.1	qt	GNU LGPL v2.1
libcurl	ICS	socat	GNU GPL v2
libdaemon	GNU GPL v2.1	spawn-fcgi	BSD
libdnet	BSD	sqlite	Public Domain
libgpg	GNU GPL v2.1	xinetd	Custom
libcap	BSD	zlib	zlib
libpng	libpng license		

## Key Features

### Video

- **Four HDMI inputs and two configurable analog video inputs** — Allows for switching between HDMI and analog video sources. Two configurable analog inputs accept most standard analog video formats, including RGB, component video, RGBcvs, S-video, and composite video signals.
- **HDMI, HDTV, RGB, and video source integration into presentation systems with audio switching** — Provides centralized switching for a wide range of AV sources.
- **Interface format correction** — Automatically reformats HDMI source signals for output to a connected DVI display.
- **Glitch-free switching** — Enhances presentations by eliminating distractions during switching with glitch-free cut through black and fade through black transition effects.
- **Two simultaneous HDMI outputs** — Drives two displays.
- **Selectable output rates** — Includes computer-video output rates from 640x480 to 1920x1200, HDTV rates up to 1080p/60, and 2048x1080.
- **Integrated DTP 230 inputs and output (IN1608 models only)**— Support digital signal transmission of HDMI or DVI plus control and analog audio up to 230 feet (70 meters) over a single CATx cable, providing high reliability and maximum performance on an easily installed cable infrastructure.

### Audio

- **Front panel output volume control** — Provides volume control for the variable, program, or mic audio output. Both fixed and variable line level outputs are available, and each output can be balanced or unbalanced. Stereo input signals can be output as dual mono.
- **Two mic/line inputs with ducking and 48 volt phantom power** — Independently mixes microphone channels with program audio which is embedded onto the HDMI outputs. Selectable 48 volt phantom power allows the use of condenser microphones.
- **Audio input gain and attenuation** — Gain or attenuation can be adjusted for each analog input to eliminate noticeable differences when switching between sources.
- **Advanced audio configuration** — Offers complete control of audio input and output gain, attenuation, mixing, and ducking parameters via internal web pages.
- **Audio breakaway** — Provides the capability to break an analog audio signal away from its corresponding video signal and route to the audio outputs.
- **Audio switching transition** — Lowers the audio of the switched-out source while simultaneously bringing up the audio of the activated source. The duration of the audio crossfade matches the duration of the video switching transition.
- **Automatic integrated audio delay** — Compensates for latency introduced by the video processing.
- **HDMI audio embedding and de-embedding** — Embeds analog audio signals onto the HDMI output signals or extracts embedded HDMI LPCM audio to the analog outputs, or passes bitstream formats.
- **Available with energy efficient Class D stereo or mono amplifier** — The IN1608 SA offers a stereo power amplifier with 50 watts per channel into 4 ohms and 25 watts per channel into 8 ohms, while the IN1608 MA offers a mono 70 volt power amplifier with 100 watts rms output. Both feature an Extron patented, highly efficient, advanced Class D amplifier design with CDRS - Class D Ripple Suppression, that provides a smooth, clean audio waveform and an improvement in signal fidelity over conventional Class D amplifier designs. CDRS eliminates the high frequency switching ripple characteristic of Class D amplifiers.

## General

- **Supported HDMI specification features** — Includes data rates up to 6.75 Gbps, Deep Color, and HD lossless audio formats
- **HDCP-compliance** — Fully supports HDCP-encrypted sources, with selectable authorization for unencrypted content.
- **HDCP authentication and signal presence confirmation** — Provides real-time verification of HDCP status for each digital video input and output. This allows for simple, quick, and easy signal and HDCP verification through front panel LEDs, RS-232, USB, or Ethernet, providing valuable feedback to a system operator or helpdesk support staff.
- **HDCP Visual Confirmation** — Sends a full-screen green signal when HDCP-encrypted content is transmitted to a non-HDCP compliant display, providing immediate visual confirmation that protected content cannot be viewed on the display.
- **Bidirectional RS-232 and IR insertion for AV device control (IN1608 models only)** — Transmits RS-232 control and IR signals alongside the video signal over DTP connections, allowing the remote device to be controlled without the need for additional cabling. Bidirectional control extension eliminates the need for control system wiring to remote devices.
- **Remote powering of DTP transmitters and receiver (IN1608 models only)** — Provides power to two remote DTP 230 transmitters and a remote DTP 230 receiver over each twisted pair connection, eliminating the need for separate power supplies at the remote units.
- **Key Minder** — Authenticates and maintains continuous HDCP encryption between input and output devices to ensure quick and reliable switching in professional AV environments, while enabling simultaneous distribution of a single source signal to one or more displays.
- **Advanced scaling engine** — Scales inputs to a common high resolution output with 30-bit processing and 1080i deinterlacing.
- **EDID Minder** — Ensures that all sources power up properly and reliably output content for display.
- **SpeedSwitch Technology** — Provides exceptional switching speed for HDCP-encrypted content.
- **Aspect ratio control** — Controls the aspect ratio by selecting a Fill mode, which provides a full screen output, or a Follow mode, which preserves the original aspect ratio of the input signal.
- **Image freeze control** — Freezes a live image.
- **Auto-Image** — Automatically detects the resolution of the incoming video signal. This can save time and effort in setting up a newly connected source, particularly in presentation environments where the input is not connected to a fixed source, but instead goes to an open connection for a presenter's laptop.
- **Auto Input Memory** — Automatically stores size, position, and picture settings based on the incoming signal. When the same signal is detected again, these image settings are automatically recalled from memory.
- **On-screen menus** — Allows for easy system setup using the front panel controls. Key parameters such as input and output video formats and resolutions are conveniently grouped on the initial Quick Setup screen, while additional screens provide full control over the unit's other functions and settings.

- **Output Standby Mode** — Mutes video and sync output to the display device when no active input signal is detected. This allows the projector or flat-panel display to automatically enter into standby mode to save energy and enhance lamp or panel life.
- **Power Save Mode** — Conserves energy when not in use.
- **Picture controls** — Includes controls for brightness, contrast, color, tint, and detail, as well as horizontal and vertical positioning, and sizing.
- **Automatic 3:2 and 2:2 pulldown detection** — Helps maximize image detail and sharpness for NTSC, PAL, and HDTV 1080i sources that originated from film.
- **Quad standard, 3D composite video decoding** — Provides advanced decoding of composite NTSC 3.58, NTSC 4.43, PAL, and SECAM for integration into systems worldwide using a temporal, 3D adaptive comb filter.
- **User presets** — Store optimized image settings to be recalled later.
- **Internal test patterns** — Include a crop pattern, grayscale, color bars, alternating pixels, blue mode, and audio pink noise for calibration and setup.
- **Front panel security lockout** — Locks out all front panel functions, except for input selection and volume control. Full controls remain available through Ethernet, USB, or RS-232 control.
- **Ethernet monitoring and control** — Enables control and proactive monitoring over a LAN, WAN, or the Internet. An intuitive web interface is included for full configuration of the device.
- **Built-in web server** — Enables the use of a standard browser for full control and troubleshooting over an intuitive web interface.
- **RS-232 control port** — Enables the use of serial commands for complete control and configuration via an integrated control system. Extron products use the SIS, Simple Instruction Set command protocol, a set of basic ASCII commands that allow for quick and easy programming.
- **Front panel USB configuration port** — Enables easy configuration without having to access the rear panel.
- **Rack-mountable 1U (IN1606 and IN1608) or 2U (IN1608 SA and IN1680 MA), full rack width metal enclosure**
- **Includes LockIt HDMI cable lacing brackets**
- **Internal universal power supply** — The 100-240 VAC, 50-60 Hz, international power supply provides worldwide power compatibility.

## Controlling the Scalers

The scalers can be controlled using one or more of the following methods:

- The front panel controls and the on-screen display (OSD) menu.
- A computer, a touch screen panel, or any other device that can send and receive serial communications through the USB, RS-232, or Ethernet port. The Extron Simple Instruction Set (SIS) is a set of simple keystroke commands that can be used with any such devices.
- Internal web pages provide a web browser-based interface for controlling the switcher from a computer over a LAN network.
- Ethernet control via IP Link, enabling the switcher to be controlled and actively monitored over a LAN, WAN, or the Internet.
- The Extron Product Configuration Software (PCS).

# Installation

This section contains information on how to connect cables to the IN1606 and IN1608 models. Topics in this section include:

- [Rear Panel Connections](#)
- [Connection Details](#)

## Rear Panel Connections

The IN1606 shares all of its connectors with the IN1608 models (see figure 3). However, the IN1608 models also include DTP inputs and an output with corresponding RS-232 and IR passthrough connectors (see figure 4). The IN1608 SA and IN1608 MA include an amplified audio output in addition to the features of the IN1606 and IN1608 (see figure 5).

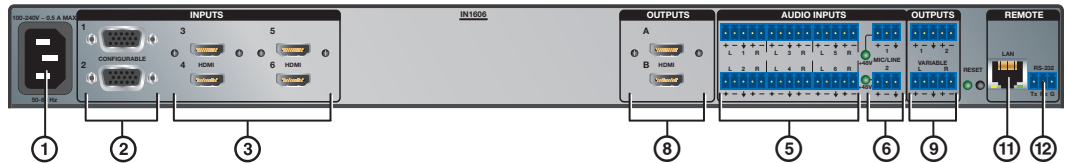

**Figure 3.** Shared Rear Panel Connectors

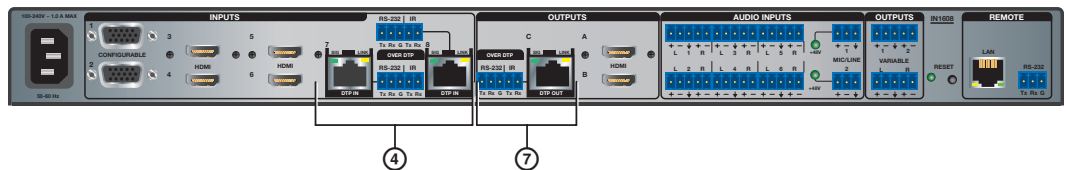

**Figure 4.** Rear Panel Connectors on IN1608 Models

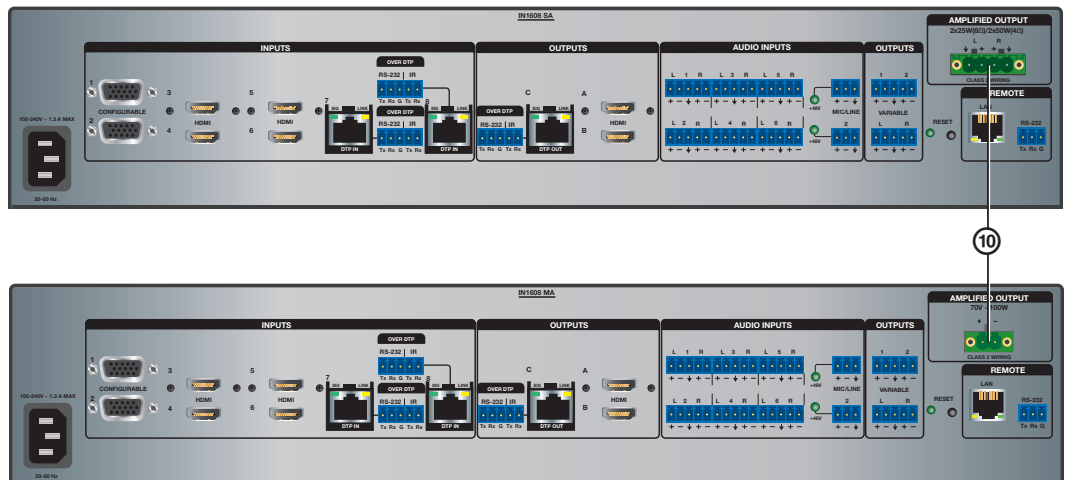

**Figure 5.** IN1608 SA and IN1608 MA Rear Panel Connectors

Power and Input Connections	Output and Control Connections
<ul style="list-style-type: none"> <li>① AC power connector</li> <li>② Analog video connectors — inputs 1 and 2</li> <li>③ HDMI connectors — inputs 3 and higher</li> <li>④ DTP input and corresponding RS-232/IR connectors — inputs 7 and 8</li> <li>⑤ Analog audio input connectors — inputs 1 to 6</li> <li>⑥ Mic/Line connectors — inputs 1 and 2</li> </ul>	<ul style="list-style-type: none"> <li>⑦ DTP output and corresponding RS-232/IR connector — output C</li> <li>⑧ HDMI connectors — outputs A and B</li> <li>⑨ Analog audio output connectors</li> <li>⑩ Amplified audio output connectors</li> <li>⑪ LAN connector</li> <li>⑫ RS-232 connector</li> </ul>

- ① **Power connector** — Connect the standard IEC power cord from a 100 to 240 VAC, 50-60 Hz power source into this connector. The front panel control and input selection buttons light in sequence during power-up.
- ② **Analog video connectors** — Connect video sources to the 15 pin HD connectors. Each accepts RGB, YUV, RGBcvs, S-video, and composite video (see [Analog Video Wiring](#) on page 12).
- ③ **HDMI input connectors** — Connect video sources to the HDMI connectors.

**TIP:** Use Extron HDMI LockIt Lacing Brackets to secure HDMI cables to the device (see [HDMI Connections](#) on page 12).

- ④ **DTP input connectors (IN1608 models only)** — Connect a DTP 230 transmitter to the DTP In RJ-45 connectors to send all signals over a single twisted pair cable (see [Twisted Pair Recommendations for DTP Communication](#) on page 13 for wiring and cable recommendations). This connection supports the following:
  - HDCP-compliant digital video
  - Embedded digital audio de-embedding from the TMDS source or analog audio
  - DTP standard RS-232 and IR pass-through signals on associated 5-pole captive screw connectors.
  - Remote power to DTP 230 transmitters

**ATTENTION:**

- Do not connect this connector to a computer or telecommunications network.
- DTP remote power is intended for indoor use only. No part of the network that uses DTP remote power should be routed outdoors.

**Signal LED** — Lights when the scaler is receiving an active video signal from a DTP transmitter.

**Link LED** — Lights when a valid link is established to a DTP transmitter.

**RS-232 port (over DTP)** — To pass bidirectional serial control between DTP-compatible devices, connect a control device to the 5-pole captive screw connector. This port only includes the 3 poles labeled “RS-232.”

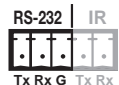

**IR port (over DTP)** — To transmit and receive IR signals, connect a control device to the 5-pole captive screw connector. This port only includes the 2 poles labeled “IR” and shares the ground pole with the RS-232 port.



**NOTE:** RS-232 and IR data can be transmitted simultaneously.

- ⑥ **Analog audio input connectors** — Connect audio sources to the 5-pole captive screw connectors associated with the desired input. Wire the connector for line level, balanced or unbalanced, analog stereo.

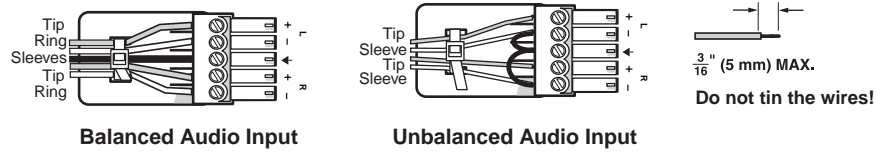

**Figure 6. Audio Input Connector Wiring**

- ⑥ **Mic/line connectors** — Connect unbalanced audio sources to the 3-pole captive screw connectors for configurable MIC or LINE level inputs.

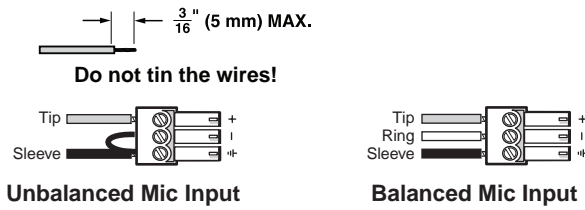

**Figure 7. Mic/Line Connector Wiring**

- ⑦ **DTP output connector (IN1608 models only)** — Connect a DTP 230 receiver to the DTP Out RJ-45 connector to send all signals over a single twisted pair cable (see [Twisted Pair Recommendations for DTP Communication](#) on page 13 for wiring and cable recommendations). This connection supports the following:

- HDCP-compliant digital video
- Re-embedded program audio into the TMDS output or analog audio
- DTP standard RS-232 and IR pass-through signals on associated 5-pole captive screw connectors.
- Remote power to DTP 230 receiver

**ATTENTION:**

- Do not connect this connector to a computer or telecommunications network.
- DTP remote power is intended for indoor use only. No part of the network that uses DTP remote power should be routed outdoors.

**Signal LED** — Lights when the scaler is receiving an active video signal from a DTP transmitter.

**Link LED** — Lights when a valid link is established to a DTP transmitter.

**RS-232 port (over DTP)** — To pass bidirectional serial control between DTP-compatible devices, connect a control device to the 5-pole captive screw connector. This port only includes the 3 poles labeled “RS-232.”

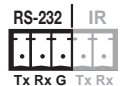

**IR port (over DTP)** — To transmit and receive IR signals, connect a control device to the 5-pole captive screw connector. This port only includes the 2 poles labeled “IR” and shares the ground pole with the RS-232 port.



**NOTE:** RS-232 and IR data can be transmitted simultaneously).

- ⑧ **Amplified audio output connector (IN1608 SA and IN1608 MA models only)** — Connect speakers to the 4-pole or 2-pole captive screw connector.



- ⑧ **HDMI output connectors** — Connect display devices to the HDMI connectors. Use one of these connectors for a local monitor to display the OSD menu (see **Operation** on page 14).

**TIP:** Use Extron HDMI LockIt Lacing Brackets to secure HDMI cables to the device (see **HDMI Connections** on page 12).

- ⑨ **Analog audio output connectors** — Connect audio output devices to these 5-pole captive screw connectors. Wire the connector for line level, balanced or unbalanced, analog stereo.

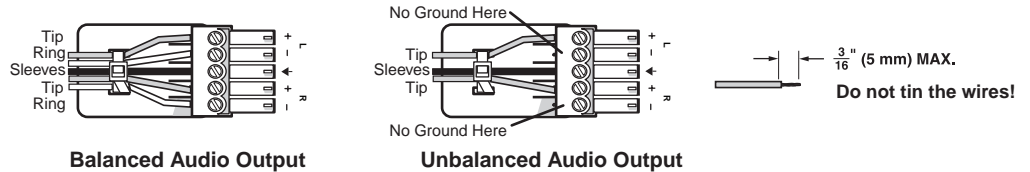

**Figure 8. Audio Output Connector Wiring**

- ⑧ **LAN connector** — Connect a computer network to this RJ-45 connector. Use a patch cable to connect to a switch, hub, or router. Wire the connector as shown below.

Pin	T568A Wire Color	T568B Wire Color
1	White-green	White-orange
2	Green	Orange
3	White-orange	White-green
4	Blue	Blue
5	White-blue	White-blue
6	Orange	Green
7	White-brown	White-brown
8	Brown	Brown

↑  
Insert Twisted Pair Wires  
**RJ-45 Connector**

LEDs on this connector indicate link and activity status.

- ⑨ **RS-232 connector** — Connect a host device to this 3-pole captive screw connector for RS-232 serial control. The default baud rate is 9600.

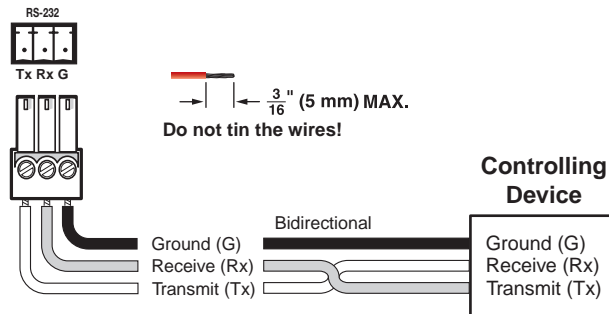
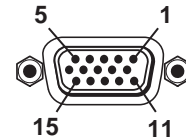

**Figure 9. RS-232 Wiring**

## Connection Details

### Analog Video Wiring

Pinout Table for 15-pin HD Connectors						
Pin	RGBHV	RGBs	RGBcvS	Component	S-video	Composite
1	Red	Red	Red	R-Y		
2	Green	Green	Green	Y	Luma	Video
3	Blue	Blue	Blue	B-Y	Chroma	
4						
5	H Sync Return	C Sync Return	Sync Return			
6	Red Return	Red Return		R-Y Return		
7	Green Return	Green Return		Y Return	L Return	Video Return
8	Blue Return	Blue Return		B-Y Return	C Return	
9						
10	V Sync Return/ DDC Return	DDC Return				
11						
12	EDID/DDC	EDID/DDC				
13	H Sync	C Sync	Composite Video			
14	V Sync					
15	EDID/DDC	EDID/DDC				



### HDMI Connections

Use an Extron LockIt Lacing Bracket to secure an HDMI cable to each device.

1. Plug the HDMI cables into the panel connection.
2. Loosen the side HDMI connection mounting screw from the panel enough to allow the LockIt lacing bracket to be placed over it. The screw does not have to be removed.
3. Place the LockIt lacing bracket on the screw and against the HDMI connector, then tighten the screw to secure the bracket.

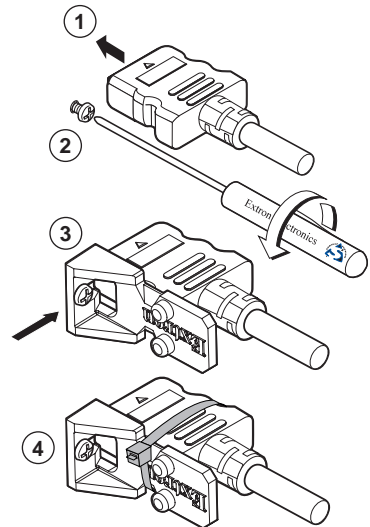

**ATTENTION:** Do not overtighten the HDMI connector mounting screw. The shield to which it is fastened to is very thin and can easily be stripped.

4. Loosely place the included tie wrap around the HDMI connector and the LockIt lacing bracket.
5. While holding the connector securely against the lacing bracket, use pliers or similar tools to tighten the tie wrap, then remove any excess length.

The LockIt bracket can also be used in a stacked formation, as shown below.

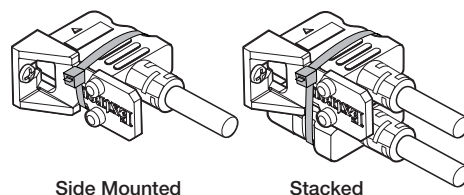
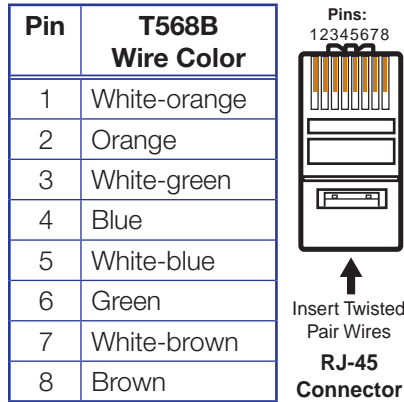

**Figure 10. LockIt Bracket Mounting Options**

## Twisted Pair Recommendations for DTP Communication

**ATTENTION:** Do not use Extron UTP23SF-4 Enhanced Skew-Free AV UTP cable or STP201 cable to link the scaler with DTP transmitters or receivers.

Use the following pin configurations for twisted pair cables.



**Figure 11. Twisted Pair Cable Configuration**

### Supported cables

The scalers are compatible with CAT 5e, 6, 6a, and 7 shielded twisted pair (F/UTP, SF/UTP, and S/FTP) and unshielded twisted pair (U/UTP) cable.

### Cable recommendations

Extron recommends using the following practices to achieve full transmission distances up to 230 feet (70 m) and reduce transmission errors.

- Use the following Extron XTP DTP 24 SF/UTP cables and connectors for the best performance:
  - **XTP DTP 24/1000** Non-Plenum 1000' (305 m) spool 22-236-03
  - **XTP DTP 24P/1000** Plenum 1000' (305 m) spool 22-235-03
  - **XTP DTP 24 Plug** Package of 10 101-005-02
- If not using XTP DTP 24 cable, at a minimum, Extron recommends 24 AWG, solid conductor, STP cable with a minimum bandwidth of 400 MHz.
- Terminate cables with shielded connectors to the TIA/EIA T 568 B standard.
- Limit the use of more than two pass-through points, which may include patch points, punch down connectors, couplers, and power injectors. If these pass-through points are required, use CAT 6 or 6a shielded couplers and punch down connectors.

**NOTE:** When using CAT 5e or CAT 6 cable in bundles or conduits, consider the following:

- Do not exceed 40% fill capacity in conduits.
- Do not comb the cable for the first 20 m, where cables are straightened, aligned, and secured in tight bundles.
- Loosely place cables and limit the use of tie wraps or hook and loop fasteners.
- Separate twisted pair cables from AC power cables.

# Operation

This section contains information on the front panel operation, On-Screen Display Menu System, and reset modes of the scalers. Topics in this section include:

- [Front Panel Overview](#)
- [Powering Up](#)
- [Input Selection](#)
- [On-Screen Display \(OSD\) Menu System](#)
- [Front Panel Lockout \(Executive Modes\)](#)
- [Reset Modes](#)

## Front Panel Overview

The scalers have the same front panel features except for the number of input selection buttons and input and output LED indicators.

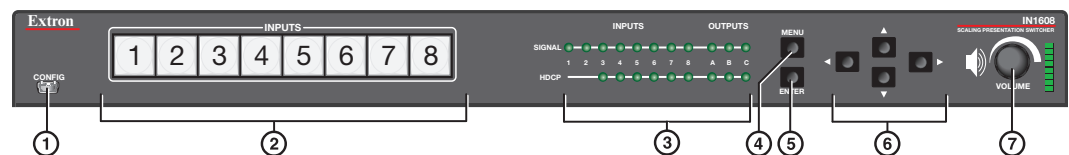

**Figure 12. Front Panel Features (IN1608)**

- ① **Config port** — Connect a host device to the mini-USB B connector.
- ② **Input selection buttons** — Press one of these buttons to select an input. The buttons light amber for audio and video selections, red for audio-only selections, or green for video-only selections. The number of input selection buttons depends on the scaler model (The IN1606 has six and the IN1608 models have eight).
- ③ **Input and output LED indicators**

The number of input and output LED indicators depends on the scaler model.

**Input signal LEDs** — Light for each input when active video content is detected.

**Output signal LEDs** — Light green when active video is being output or blink amber when video output and sync are disabled from the scaler.

**Input HDCP LEDs** — Light for each input signal that is HDCP-encrypted. Analog inputs 1 and 2 cannot be HDCP-encrypted.

**Output HDCP LEDs** — Light for the active output when it is HDCP-encrypted.
- ④ **Menu button** — Press this button to enter or exit the OSD menu system.
- ⑤ **Enter button** — Press this button to select options from the OSD menu system.
- ⑥ **Direction buttons** — Press any of the four buttons to navigate the OSD menu system or change values of adjustable features.
- ⑦ **Volume knob** — Rotate this knob to adjust output (default), program, or mic volume.

**Volume LEDs** — Light in order from bottom to top according to the audio volume level. There are eight LED steps from 1% (-99 dB) to 99% (-1 dB). Every quarter turn of the volume knob equates to a one step increment (about 12.5%). When the volume is muted (0%), the bottom LED blinks. When the volume is at 100%, the top LED blinks.

## Powering Up

When power is applied to the scaler, the Input selection buttons light amber, green, and then red before illuminating just the selected input.

## Input Selection

Press any of the Input selection buttons on the front panel to select an input. The current active input lights as follows:

Input Selection Button Lights	
Color	Signal
Amber	Audio and video
Green	Video only
Red	Audio only

## On-Screen Display (OSD) Menu System

Scaler configuration and adjustments can be performed by using the internal Web pages (see [Internal Web Pages](#) on page 56), the Product Configuration Software (see [Configuration Software](#) on page 50), the Extron Simple Instruction Set (SIS) of commands (see [SIS Configuration and Control](#) on page 29), or by using the front panel controls and the OSD menu. The OSD menu is used primarily when the scaler is first set up.

**NOTE:** The OSD menu has a fixed time-out of 60 seconds.

### Menu Navigation Using Front Panel Controls

**Menu button** — Press the Menu button to activate the OSD menu or close submenus and settings.

**Enter button** — Press the Enter button to activate the OSD menu or select submenu items.

**Navigation buttons** — Press the Up (▲) button or the Down (▼) button to navigate submenus or submenu items. Press the Right (▶) button to access currently selected submenus or submenu items. Press the Left (◀) button to exit currently selected submenus or submenu items. Also use the navigation buttons to adjust settings according to specific setting directions.

**Input Selection buttons** — Press any of the Input selection buttons to change the selected input.

## Menu Overview

In the OSD menu, the IP address and firmware version are displayed in the top border. The active input settings and output resolution are displayed in the bottom border. The OSD menu contains nine submenus with various submenu items of adjustable settings or device information. Use the Menu, Enter, and Navigation buttons to navigate the OSD menu.

### To open the OSD menu:

1. Connect a display device to an HDMI output connector.
2. Press the Menu or Enter button to open the OSD menu.

### To navigate the OSD menu:

1. Press the Up or Down button to navigate the nine submenus. The following table shows the nine submenus and their respective submenu items.

Submenus	Submenu Items							
<b>Quick Setup</b>	Auto-Image	Input Format	EDID	Output Resolution	Audio Mute	Test Pattern	DHCP	IP Address
<b>User Presets</b>	Recall	Save	Clear					
<b>Picture Controls</b>	Image Position	Image Size	Brightness/Contrast	Color/Tint	Detail			
<b>Input</b>	Auto-Image	Input Format	Film Mode	Horizontal/Vertical Start	Horizontal/Vertical Active	Total Pixels/Phase	HDCP Authorization	EDID
<b>Output</b>	Resolution	HDMI "A" Format	HDMI "B" Format	DTP "C" Format (IN1608)	HDCP Notification			
<b>Audio</b>	Audio Mute	Audio Format	Gain	Mic/Line 1 Gain/Phantom	Mic/Line 2 Gain/Phantom	Mic/Line Volume	Program Volume	Output 1/2 Format
<b>Advanced</b>	Test Pattern	Screen Saver/Timeout	Auto-Image	Aspect Ratio	Auto Memory	Overscan	Auto Switch	Factory Reset
<b>Communication</b>	Remote Port	MAC Address	DHCP	IP Address	Subnet Mask	Gateway		
<b>Device Info (Read Only)</b>	Unit Name	Firmware	Temperature	Active Input Details	Active Output Details	Detected Displays		

**NOTE:** The Communication submenu is normally locked. Press and hold the Enter button for 10 seconds to unlock the submenu items.

2. Press the Enter or Right button to open submenu items.
3. Press the Up or Down button to navigate the submenu items.
4. Press the Menu button to exit a submenu item or return to the previous submenu.

### To adjust a submenu item:

1. Navigate to an adjustable item and press the Enter or Right button to select the submenu item.
2. Press the Left or Right button to select a submenu item or a specific adjustable setting within the selected submenu item.

If the selected submenu item has multiple adjustable settings, press the Up or Down button to select a value.

3. Press the Enter button to accept the new value.  
Press the Menu button to cancel any pending changes.

### To exit the OSD menu:

Hold the Menu button for 3 seconds to exit the OSD menu.

## Quick Setup Submenu

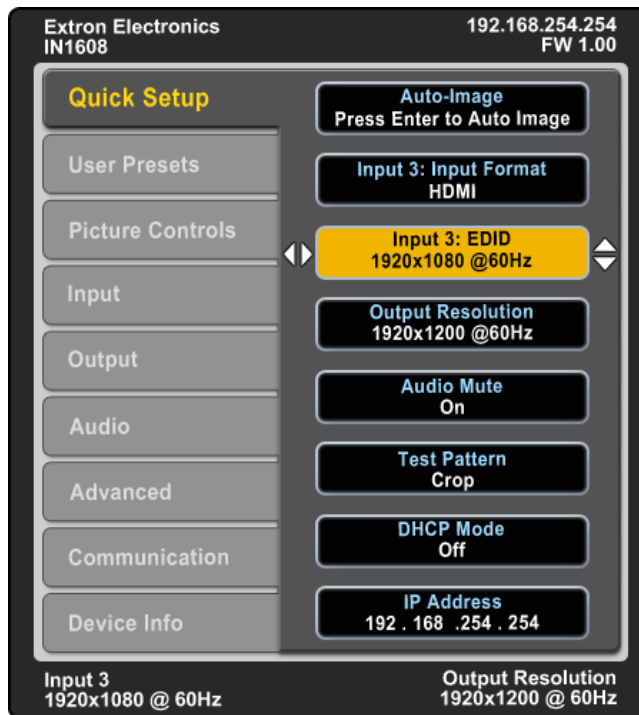

**Figure 13. Quick Setup Submenu (IN1608)**

The Quick Setup submenu allows quick access to common input, output, and communication settings. This submenu contains the following submenu items:

**Auto-Image** — Press the Enter button to execute an Auto-Image on the current input (see [Auto-Image](#) on page 20).

**Input Format** — Press the Navigation buttons to select the desired video input format (see [Input Format](#) on page 21). The current input is displayed in the title of the submenu.

**Input EDID** — Press the Navigation buttons to select a discrete EDID or match the output resolution (see [EDID](#) on page 21). The current input is displayed in the title of the submenu.

**Output Resolution** — Press the Navigation buttons to select from a list of output resolutions and refresh rates (see [Resolution](#) on page 22). There are eight custom options, prefaced by C1 through C8. The default setting is 720p @ 60 Hz.

**Audio Mute** — Press the Navigation buttons to globally mute or unmute the audio.

**Test Pattern** — Press the Navigation buttons to select an available test pattern to display or to turn a test pattern off (see [Test Pattern](#) on page 24). The available test patterns are Crop, Alternating Pixels, Color Bars, Grayscale, Blue Mode, and Audio Test Pattern (pink noise). The default setting is Off.

**DHCP** — Press the Navigation buttons to enable or disable DHCP mode.

**IP Address** — Press the Left and Right buttons to change octets. Press the Up and Down buttons to change the value of a selected octet.

## User Presets Submenu



**Figure 14. User Presets Submenu (IN1608)**

The User Preset submenu saves the current picture control settings for the selected input. Use presets can be saved and recalled later on another input, allowing them to also be used as aspect ratio or discrete size and center shortcuts. There are 16 user presets available per input. Press the Input Selection buttons to select an input.

**NOTE:** If a saved present is not named, “User Preset XX” is assigned.

From the Save, Recall, or Clear submenu item, press the Navigation buttons to select the desired preset to either save picture control settings, recall previously saved picture control settings, or reset a preset.

User presets save the following settings:

- Brightness and contrast
- Color and tint
- Detail
- Image size and position
- Preset name

**NOTE:** To save and recall input presets, use SIS commands (see [Preset Commands](#) on page 44) or the internal web pages (see [Preset Management Page](#) on page 76).



## Picture Controls Submenu

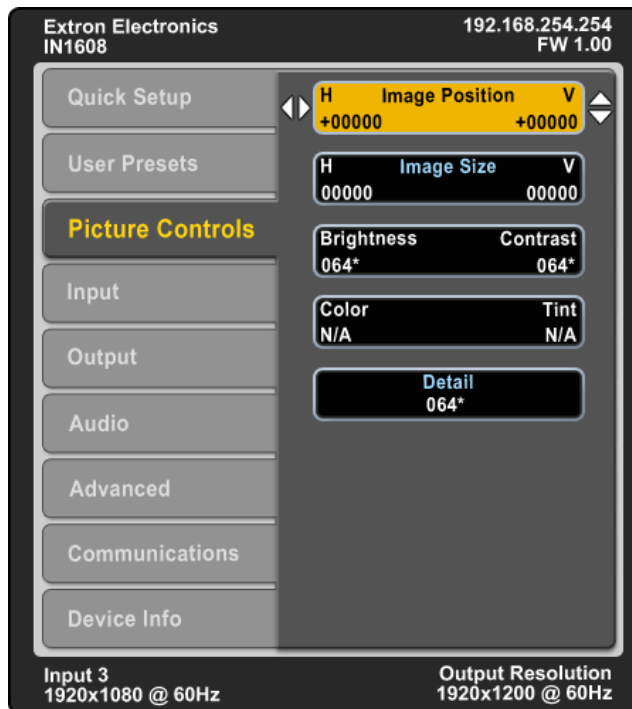

**Figure 15. Picture Controls Submenu (IN1608)**

The Picture Controls submenu allows adjustment of picture settings.

**Image Position** — Press the Left and Right buttons to select the horizontal (H) or vertical (V) position of the image. Press the Up and Down buttons to adjust the value of the selected position.

**Image Size** — Press the Left and Right buttons to select the horizontal (H) or vertical (V) size of the image. Press the Up and Down buttons to adjust the value of the selected position.

**Brightness and Contrast** — Press the Left and Right buttons to select the brightness or contrast of the image. Press the Up and Down buttons to adjust the value of the selected feature.

**Color and Tint** — Press the Left and Right buttons to select the color or tint of the image. Press the Up and Down buttons to adjust the value of the selected feature. These settings are only applicable to analog NTSC, PAL, and SECAM signals.

**Detail** — Press the Navigation buttons to adjust the detail of the image.

## Input Submenu



**Figure 16. Input Submenu (IN1608)**

The Input submenu allows adjustment of the active input.

**Auto-Image** — Press the Enter button to execute an Auto-Image on the active input. Auto-Image automatically updates active pixel, active lines, horizontal and vertical start, phase, horizontal and vertical image position, and horizontal and vertical image size settings.

For analog video sources with dark backgrounds or borders, the Auto-Image threshold can be adjusted with SIS commands. Raising the Auto-Image threshold ignores potential extraneous sync pulses that may have been embedded in RGB signals (see [Auto-Image threshold value](#) on page 37).

The following is performed during an Auto-Image when the aspect ratio is set to Fill:

- Horizontal and vertical image position return to 0.
- Horizontal and vertical image size fill to match the current output resolution.

The following is performed during an Auto-Image when the aspect ratio is set to Follow:

- The horizontal and vertical image position and image size is set to maintain the native aspect of the input rate with regard to the current output resolution.

Set the aspect ratio on the Advanced submenu (see [Aspect Ratio](#) on page 25).

**NOTE:** Aside from the standard Auto-Image SIS command (see the [SIS command](#) on page 37), there are unique commands to execute an Auto-Image and fill the output and to execute an Auto-Image and maintain input aspect ratio. These commands simply ignore the current aspect mode setting, Auto-Image the input, and then apply a “fill” or “follow.”

**Input Format** — Press the Navigation buttons to select an analog video input format for inputs 1 and 2. All other inputs are digital inputs for HDMI or DVI input signals. The following table shows the available input formats for each input.

Input 1	Input 2	Input 3	Input 4	Input 5	Input 6	Input 7 (IN1608)	Input 8 (IN1608)
RGB (default)	RGB (default)	HDMI (default)	HDMI (default)	HDMI (default)	HDMI (default)	HDMI (default)	HDMI (default)
YUV	YUV						
RGBcvs	RGBcvs						
S-Video	S-Video						
Composite	Composite						

**Film Mode** — Press the Navigation buttons to turn Film Mode 3:2 and 2:2 detection on (auto detect mode) or off.

**Start** — Press the Left and Right buttons to select the horizontal (H) or vertical (V) pixel start values. Press the Up and Down buttons to adjust the selected position (analog inputs only).

**Active** — Press the Left and Right buttons to select the horizontal (H) or vertical (V) active pixels. Press the Up and Down buttons to adjust the selected value (analog inputs only).

**Total Pixels and Phase** — Press the Left and Right buttons to select either Total Pixels or Phase. Press the Up and Down buttons to adjust the selected value (analog inputs only).

**HDCP Authorized** — Press the Navigation buttons to enable or disable HDCP Authorized. When HDCP Authorized is set to Disabled, the scaler appears to be non-compliant to connected source devices (digital inputs only).

**EDID** — Press the Navigation buttons to select an EDID for the active input. Select a discrete EDID from a list of factory-supplied EDID or select Match Output to use the output resolution and refresh rate (see [Resolution](#) on page 22 for a full list of available resolution and refresh rates).

## Output Submenu

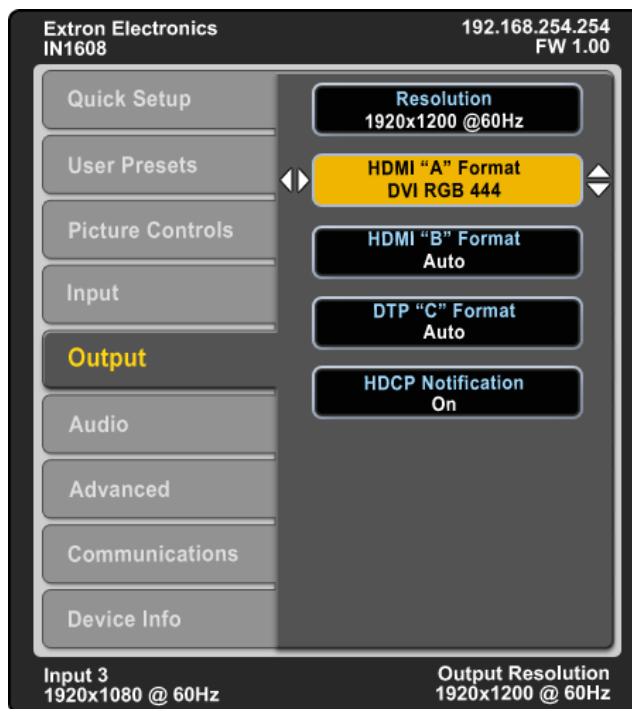

**Figure 17. Output Submenu (IN1608)**

**NOTE:** The IN1608 models include a submenu for DTP output.

The Output submenu allows configuration of the output resolution, refresh rate, HDMI format, and HDCP notification.

**Resolution** — Press the Navigation buttons to change the resolution and refresh rate from the select list. The following table shows the available resolution and refresh rates.

Resolution	23.98 Hz	24 Hz	25 Hz	29.97 Hz	30 Hz	50 Hz	59.94 Hz	60 Hz	75 Hz
640x480						X		X	X
800x600						X		X	X
852x480						X		X	X
1024x768						X		X	X
1024x852						X		X	X
1024x1024						X		X	X
1280x768						X		X	X
1280x800						X		X	X
1280x1024						X		X	X
1360x765						X		X	X
1360x768						X		X	X
1365x768						X		X	X
1366x768						X		X	X
1365x1024						X		X	X
1440x900						X		X	X
1400x1050						X		X	
1600x900						X		X	
1680x1050						X		X	
1600x1200						X		X	
1920x1200						X		X	
480p							X	X	
576p						X			
720p			X	X	X	X	X	X*	
1080i						X	X	X	
1080p	X	X	X	X	X	X	X	X	
2K (2048x1080)	X	X	X	X	X	X	X	X	
Custom 1 through 8	For captured or uploaded EDID tables								

\* Default

**NOTE:** The eight custom, user-defined output rates default to 720p @ 60 Hz when no custom EDID is captured or uploaded.

**HDMI or DTP Output Format** — After selecting HDMI “A” Format, HDMI “B” Format, or DTP “C” Format (IN1608 models only) from the list of submenus, press the Navigation buttons to set the output format. The following formats are available:

- Auto (based on display EDID)
- DVI RGB 444
- HDMI RGB 444 Full
- HDMI RGB 444 Limited
- HDMI YUV 444 Full
- HDMI YUV 444 Limited
- HDMI YUV 422 Full
- HDMI YUV 422 Limited

**HDCP Notification** — Press the Navigation buttons to enable or disable HDCP notification. When HDCP notification is enabled or On and an HDCP-encrypted input is sent to a display that is non-compliant, a green background is displayed. If HDCP notification disabled or Off, a black or muted output is displayed.

## Audio Submenu



**Figure 18. Audio Submenu (IN1608)**

The Audio submenu allows users to adjust audio settings.

**Audio Mute** — Press the Navigation buttons to globally mute or unmute audio output.

**Audio Format** — Press the Navigation buttons to select the audio input format. Analog inputs can only be set to Analog or None. All other inputs can accept all audio input formats.

Audio Input Format	Details	Inputs
None	Mutes audio for the selected input. Sets “No Audio” EDID.	All
Analog	Sets the selected input to analog. Sets “No Audio” EDID.	All
LPCM-2Ch	Sets the selected input to LPCM-2Ch audio. Sets 2Ch audio EDID.	3+
Multi-Ch	Sets the selected input to Multi-Ch audio. Sets Multi-Ch audio EDID.	3+
LPCM-2Ch Auto	Sets the selected input to prioritize digital audio. Analog audio is passed when digital is not present. Sets 2Ch audio EDID.	3+
Multi-Ch Auto	Sets the selected input to prioritize digital audio. Analog audio is passed when digital is not present. Sets Multi-Ch audio EDID.	3+

**Gain** — Press the Navigation buttons to set the gain (in dB) for the active analog input.

**Mic/Line Gain and Phantom** — After selecting Mic/Line 1 or Mic/Line 2 from the list of submenus, press the Left and Right buttons to select the Mic/Line gain or phantom power status. Press the Up and Down buttons to set the gain (in dB) or enable or disable phantom power for the selected value.

**Mic/Line Volume** — Press the Navigation buttons to set the Mic/Line mix volume (in dB).

**Program Volume** — Press the Navigation buttons to set the Program mix volume (in dB).

**Output 1/2 Format** — Press the Navigation buttons to set the audio output format.

## Advanced Submenu

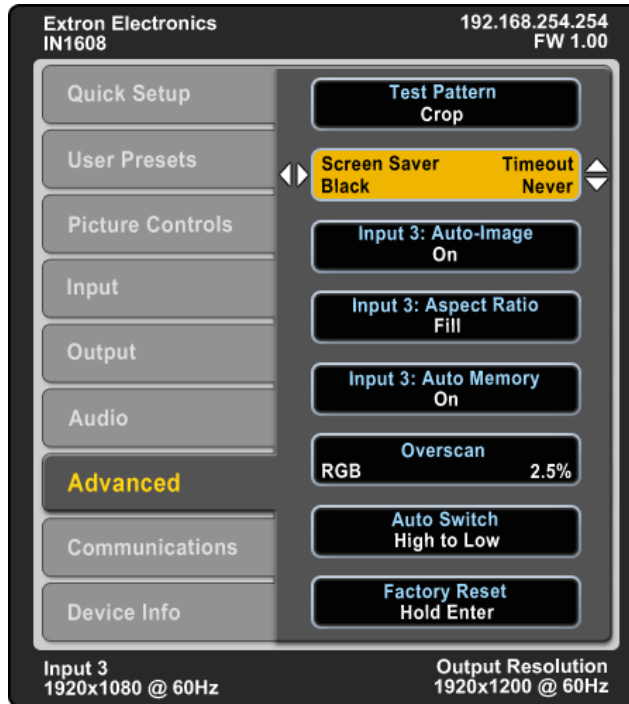

**Figure 19. Advanced Submenu (IN1608)**

The Advanced submenu allows adjustment of test patterns, screen saver mode, automatic Auto-Image, aspect ratio, auto memory, overscan settings, auto switch, and factory reset.

**Test Pattern** — Press the Navigation buttons to select a test pattern to display or to turn a test pattern off. The available test patterns are Crop, Alternating Pixels, Color Bars, Grayscale, Blue Mode, and Audio Test (pink noise). The default setting is Off.

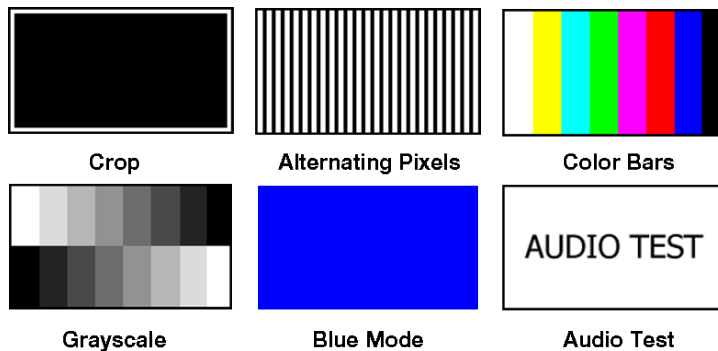

**Figure 20. Available Test Patterns**

**NOTES:**

- The audio test outputs pink noise on the embedded digital audio output (2-channel, 48 kHz, 16 bit).
- All test patterns include a single pixel border (except Blue mode).

**Screen Saver and Timeout** — Press the Left and Right buttons to select the screen saver or time-out setting. Press the Up and Down buttons to set the screen saver to a Black (default) or Blue screen or the time-out duration to a specified number seconds.

When there is no active video on the selected input, the device can mute the video output to black or blue for a set duration before disabling output sync. By default, the scaler outputs black video and continually output sync (no sync time-out) with no active input applied.

The time-out duration can be set to Never (default), or to any duration from 1-500 seconds.

**Auto-Image** — Press the Navigation buttons to turn the automatic per-input Auto-Image mode On or Off (default).

When enabled and a new input frequency is detected, the scaler first applies an existing Auto Memory for the signal (if Auto Memory is enabled). If no entry exists, it performs an automatic Auto-Image on the new signal. This sets a size and position for the image to fill the screen, with respect to the current Aspect Ratio setting.

**Aspect Ratio** — Press the Navigation buttons to set the aspect ratio setting of the active input to Fill (default) or Follow.

When in Fill mode, all inputs will automatically fill the entire output. If an aspect ratio adjustment for a single input rate is desired, the correct size and center can be set up using Image Size and Image Position under Picture Controls (see **Picture Controls Submenu** on page 19). If auto memory is enabled, then these settings are saved and recalled the next time the signal is detected.

In Follow mode, each input rate is displayed with its native aspect ratio mode with the correct letter box or pillar box settings visible.

The scaler clears the previous size and position settings whenever the aspect ratio setting for an input is adjusted.

**Auto Memory** — Press the Navigation buttons to turn Auto Memory on or off for each input. The scaler stores 32 auto memories per input, with input configuration and picture control data for each video resolution. The default setting enables these memories to automatically recall input and picture controls for previously applied signals. When auto memories are disabled, the scaler treats every applied signal as a new source.

Auto Memory and Auto-Image Interaction		
Auto Memory	Auto-Image	Information
On	On	“New” signals and rates not previously detected by the scaler, are initially set up using default parameters, then Auto-Image is automatically applied. The next time the signal is detected, the values stored in the auto memory location are applied.
On (default)	Off (default)	“New” signals and rates not been previously detected by the scaler, are set up using default parameters. If manual input or picture settings are made to the input, an auto memory location is created and recalled each time the input is detected.
Off	On	Each change in input sync, input switch, or power cycle triggers an automatic Auto-Image. When auto memory is disabled, each change in sync is treated as a new signal and an automatic Auto-Image is triggered. Manual changes made to the image and picture controls are lost each time a new rate is detected.
Off	Off	Each change in input sync causes default values to be applied. Manual changes made to the image and picture controls are lost when a new rate is applied, a new input is applied, or after a power cycle.

**Overscan** — Press the Navigation buttons to select the overscan value for each input format. Choose between 0%, 2.5%, or 5%. Set default overscan mode through SIS commands (see **SIS Configuration and Control** on page 29).

Overscan is specific to each input signal type. This feature zooms and crops SMPTE input resolutions to mask edge effects and ancillary data that are common in broadcast signals. When the overscan mode is not at 0%, an Auto-Image on a SMPTE input rate (NTSC, PAL, SECAM, 480p, 576p, 720p, 1080i, 1080p, and 2K [2048x1080]) refers to the default input lookup table values instead of performing a “true” auto image.

**NOTE:** Overscan is valid only on SMPTE input rates (NTSC, PAL, 480p, 576p, 720p, 1080i, 1080p, or 2K [2048x1080]) and is global for each video format.

**Auto Switch** — Press the Navigation buttons to turn the auto switch mode on or off, and to set the priority. The auto switch setting allows for basic, unmanaged, input switching based on the presence of active input signals. Auto switch mode options are:

- Disabled (off)
- Setting priority to “high to low” (highest numbered active input to the lowest)
- Setting priority to “low to high” (lowest numbered active input to the highest)

**Factory Reset** — Press and hold the Enter button to reset the device to factory defaults. The scaler retains the current firmware version, as well as communication and IP settings.

## Communication Submenu

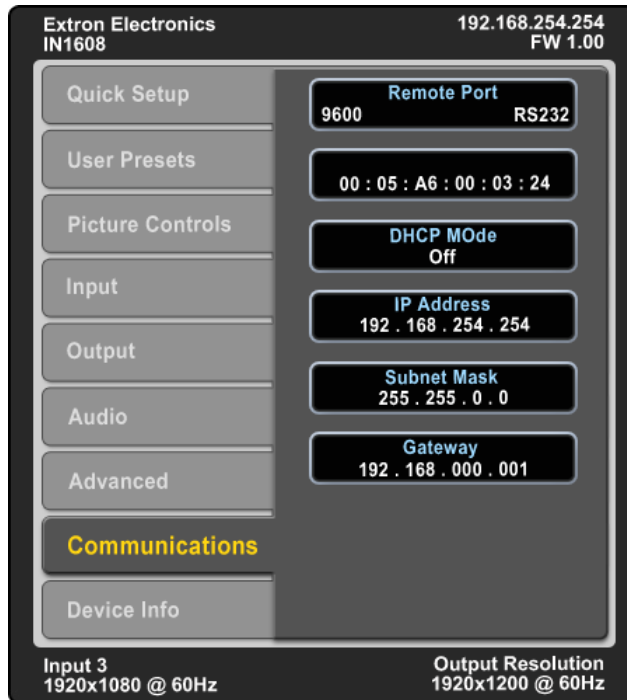

**Figure 21. Communication Submenu (IN1608)**

The Communication submenu displays RS-232 settings, current IP configuration (DHCP, IP, Subnet, Gateway), and MAC address. Press and hold the Enter button for 10 seconds to edit the submenu items listed below.

**Remote Port** — Displays the Baud rate for the serial RS-232.

**MAC Address** — Displays the MAC address of the device (read only).

**DHCP** — Press the Navigation buttons to turn the DHCP mode on or off. The default is Off.



**IP Address** — Press the Left and Right buttons to select an octet of the IP address. Press the Up and Down buttons to adjust the value of the selected octet. The default is 192.168.254.254.

**Subnet Mask** — Press the Left and Right buttons to select an octet of the subnet mask address. Press the Up and Down buttons to adjust the value of the selected octet. The default is 255.255.0.0.

**Gateway** — Press the Left and Right buttons to select an octet of the gateway address. Press the Up and Down buttons to adjust the value of the selected octet. The default is 0.0.0.0.

## Device Info Submenu

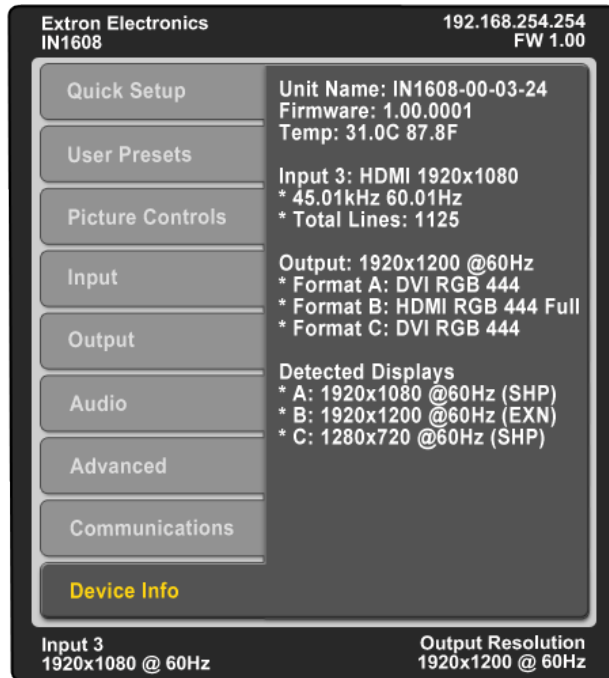

**Figure 22. Device Info Submenu (IN1608)**

The Device Info submenu displays device information including unit name, firmware version, internal temperature, input and output signal information, and detected display information. This submenu does not contain any adjustable submenu items.

## Front Panel Lockout (Executive Modes)

The scalers have three modes of front panel security lock that limit the operation of the device from the front panel.

**Executive mode 0 (disabled)** — Unlocks front panel functions. This is the default setting.

**Executive mode 1 (enabled)** — Locks all front panel functions completely. This mode can be enabled or disabled only by SIS commands. All functions can still be made through USB, RS-232, or Ethernet control (see [SIS Communication and Control](#) on page 29, [Configuration Software](#) on page 50, or [Internal Web Pages](#) on page 56).

**Executive mode 2 (enabled)** — Locks all front panel functions except input switching and volume control. All functions and adjustments can still be made through USB, RS-232, or Ethernet control (see [SIS Communication and Control](#) on page 29, [Configuration Software](#) on page 50, or [Internal Web Pages](#) on page 56).

To enable executive mode 2, press and hold the Menu and Enter buttons simultaneously for 3 seconds.

The menu system returns to the default menu within 10 seconds.

## Reset Modes

There are three reset modes (numbered 1, 4, and 5). These are available by pressing the recessed Reset button on the rear panel (see the following table for a summary of the reset modes).

**ATTENTION:** Review the reset modes carefully. Using the wrong reset mode may result in unintended loss of flash memory programming, port reassignment, or processor reboot.

**NOTE:** The reset modes listed close all open IP and Telnet connections and all sockets. Each mode is a separate function, not a continuation from mode 1 to mode 5.

Reset Mode Summary			
Mode	Activation	Result	Purpose/Notes
Use Factory Firmware	<p><b>1</b> Hold down the recessed Reset button for 30 seconds while applying power to the scaler.</p> <div style="border: 1px solid blue; padding: 5px; margin-top: 10px;"> <p><b>NOTE:</b> After a mode 1 reset, update the device with the latest firmware version. <b>DO NOT</b> operate the firmware version that results from this mode reset. This temporarily resets the device to factory default until power is recycled. To use factory default firmware, upload that version again.</p> </div>	<p>The device reverts to the factory default firmware:</p> <ul style="list-style-type: none"> <li><b>a.</b> Reverts to the factory default firmware for a <b>single power cycle</b>.</li> <li><b>b.</b> All user files and settings (drivers, audio and video adjustments, IP settings, etc.) are maintained.</li> </ul> <div style="border: 1px solid blue; padding: 5px; margin-top: 10px;"> <p><b>NOTE:</b> If you do not want to update the firmware or perform a mode 1 reset by mistake, cycle power to the device to return the firmware version running prior to the reset.</p> </div>	<p>Use mode 1 to revert to the factory default version if incompatibility issues arise with user-loaded firmware.</p>
Reset IP Settings	<p><b>4</b> Hold down the Reset button for about 6 seconds until the Reset LED blinks twice. Then press Reset momentarily (&lt;1 second).</p>	<p>IP settings revert to factory defaults.</p> <ul style="list-style-type: none"> <li>• Reverts port mapping back to factory default.</li> <li>• Turns DHCP off.</li> <li>• IP address is set to 192.168.254.254.</li> <li>• Reset LED blinks four times in quick succession during reset.</li> </ul>	<p>Resets all IP settings back to factory defaults.</p>
Reset to Factory Default	<p><b>5</b> Hold down the Reset button for about 9 seconds until the Power LED blinks 3 times. Then press Reset momentarily (&lt;1 second).</p>	<p>The device reverts to the factory defaults except for firmware.</p> <ul style="list-style-type: none"> <li><b>a.</b> Performs everything a mode 4 reset does.</li> <li><b>b.</b> Resets all user modifiable configuration to default values including IP settings and real-time adjustments.</li> <li><b>c.</b> Deletes all user loaded files.</li> <li><b>d.</b> The Reset LED blinks 4 times in quick succession during the reset.</li> </ul>	<p>Use mode 5 to restart with default configuration. This is equivalent to SIS command ZQQQ.</p>

# SIS Configuration and Control

The scaler can be configured and controlled with Extron Simple Instruction Set (SIS) commands when connected to a host computer or other device (such as a control system). Attach the host device to the rear panel RS-232 connector, the LAN port, or the front panel USB port. Commands can be entered using a Telnet application such as the Extron DataViewer, available at [www.extron.com](http://www.extron.com) (see the *DataViewer Help* file for more details). This section describes SIS communication and control. Topics in this section include:

- [Host and Scaler Communication](#)
- [SIS Overview](#)
- [Command and Response Tables](#)

The scaler uses a protocol of 9600 baud, 1 stop bit, no parity, and no flow control (see [RS-232 Connector](#) on page 11).

## Host and Scaler Communication

SIS commands consist of one or more characters per field. No special characters are required to begin or end a command sequence. When the scaler determines that a command is valid, it executes the command and sends a response to the host device. All responses from the scaler to the host end with a carriage return and a line feed (CR/LF = `↵`), indicating the end of the response character string (one or more characters).

### Scaler-Initiated Messages

When a local event such as a front panel selection or adjustment takes place, the scaler responds by sending a message to the host. No response is required from the host. Example scaler-initiated messages are listed here.

- In `[X1] All↵` (where `[X1]` is the input number during an input switch).
- Reconfig↵ The scaler sends this response when an input is switched or when a new signal is detected.
- Hp1g0[X2]↵ The scaler sends this response when a Hot Plug event on output `[X2]` is detected.

### Copyright Information

↵ © Copyright 2013, Extron Electronics, IN1606, Vx.xx, 60-1081-01↵  
Fri, 17 Feb 2013 11:27:33 ↵

↵ © Copyright 2013, Extron Electronics, IN1608, Vx.xx, 60-1238-01↵  
Fri, 17 Feb 2013 11:27:33 ↵

↵ © Copyright 2013, Extron Electronics, IN1608 SA, Vx.xx, 60-1238-02↵  
Fri, 17 Feb 2013 11:27:33 ↵

↵ © Copyright 2013, Extron Electronics, IN1608 MA, Vx.xx, 60-1238-03↵  
Fri, 17 Feb 2013 11:27:33 ↵

The copyright message is displayed upon connecting to a scaler via TCP/IP or Telnet or after a power cycle via RS-232 and depends on the scaler model. Vx.xx is the firmware version number. The current date and time are displayed.

## Password Information

The **← Password:** prompt requires a password (administrator level or user level) followed by a carriage return. The prompt is repeated if the correct password is not entered. If the correct password is entered, the unit responds with **← Login Administrator ←** or **← Login User ←**, depending on password entered. If passwords are the same for both administrator and user, the unit defaults to administrator privileges.

## Error Responses

When the scaler receives a valid command, it executes the command and sends a response to the host device. If the unit is unable to execute the command, it returns an error response to the host.

### Error values

E01 — Invalid input number	E17 — Invalid command for signal type
E10 — Invalid command	E22 — Busy
E11 — Invalid preset number	E24 — Privilege violation
E12 — Invalid port number	E25 — Device not present
E13 — Invalid parameter	E26 — Maximum number of connections exceeded
E14 — Not valid for this configuration	E28 — Bad filename or file not found

### Error response references

These references in the command and response tables note particular error responses to that command.

<sup>14</sup> = Commands that give an E14 (invalid command for this configuration) error if sent to a product whose current configuration does not support the command.

<sup>24</sup> = Commands that give an E24 (privilege violation) error if not administrator level.

<sup>28</sup> = Commands that may give an E28 (file not found) error.

# SIS Overview

## Using the Command and Response Tables

The Command and Response tables for SIS commands later in this section lists the commands that the scaler recognizes as valid, the responses that are returned to the host, a description of the command's function or the results of executing the command, and select examples of commands in ASCII (Telnet) and URL encoded (web).

**NOTE:** Upper and lower case text can be used interchangeably unless otherwise stated.

ASCII to Hex Conversion Table													Esc	1B	CR	0D	LF	0A				
Space →	20	!	21	"	22	#	23	\$	24	%	25	&	26	'	27							
(	28	)	29	*	2A	+	2B	,	2C	-	2D	.	2E	/	2F							
0	30	1	31	2	32	3	33	4	34	5	35	6	36	7	37							
8	38	9	39	:	3A	;	3B	<	3C	=	3D	>	3E	?	3F							
@	40	A	41	B	42	C	43	D	44	E	45	F	46	G	47							
H	48	I	49	J	4A	K	4B	L	4C	M	4D	N	4E	O	4F							
P	50	Q	51	R	52	S	53	T	54	U	55	V	56	W	57							
X	58	Y	59	Z	5A	[	5B	\	5C	]	5D	^	5E	_	5F							
.	60	a	61	b	62	c	63	d	64	e	65	f	66	g	67							
h	68	i	69	j	6A	k	6B	l	6C	m	6D	n	6E	o	6F							
p	70	q	71	r	72	s	73	t	74	u	75	v	76	w	77							
x	78	y	79	z	7A	{	7B		7C	}	7D	~	7E	DEL	7F							

Figure 23. ASCII to Hexadecimal Character Conversion Table

## Symbol Definitions

- = Space
- ↵ = Carriage return with line feed
- ↵ or ← = Carriage return with no line feed
- Esc or W = Escape
- <sup>14, 24, 28</sup> = Superscripts indicate the error message displayed if the command is entered incorrectly or with invalid parameters (see [Error response references](#) on page 30)
- X1 = Input selection  
1 - 6 (IN1606)  
1 - 8 (IN1608 models only)
- X2 = Output selection  
1 = HDMI A (top)  
2 = HDMI B (bottom)  
3 = DTP C (IN1608 models only)
- X3 = Input video format  
1 = RGB  
2 = YUV  
3 = RGBcvS  
4 = S-video  
5 = Composite  
6 = HDMI
- X4 = Horizontal or vertical start  
0 - 255 (default midpoint of 128 translates to the default value in the input lookup tables)
- X5 = Pixel phase  
0 - 63 (31 = default)
- X6 = Total pixels  
±512 of the default value
- X7 = Active pixels  
±512 of the default value
- X8 = Active lines  
±256 of the default value
- X9 = Enable or disable  
0 = off or disabled  
1 = on or enabled

<b>X10</b>	= Input standard	0 = no signal detected on the current input 1 = NTSC 3.85 2 = PAL 3 = NTSC 4.43 4 = SECAM - = N/A (occurs when the input is active RGB, YUV, or HDMI signal)
<b>X11</b>	= Internal temperature	In degrees Celsius
<b>X12</b>	= Film detect mode	0 = disabled 1 = auto (default)
<b>X13</b>	= Horizontal and vertical frequencies	xxx.x
<b>X14</b>	= Text label	Up to 63 characters.
<b>X15</b>	= Picture adjustment	0 - 127 (64 = default)
<b>X16</b>	= Horizontal position	±2048
<b>X17</b>	= Vertical position	±1200
<b>X18</b>	= Horizontal size	0 - 04096
<b>X19</b>	= Vertical size	0 - 02400
<b>X20</b>	= Test patterns	0 = off (default) 1 = crop 2 = alternating pixels 3 = color bars 4 = grayscale 5 = blue mode 6 = audio test pattern (pink noise)
<b>X21</b>	= User presets	01 - 16
<b>X22</b>	= Input presets	1 - 128
<b>X23</b>	= On-screen display bug time-out Output sync time-out	0 = OSD is never displayed, output sync is instantly disabled with no active input 1 - 500 = 1 second increments 3 = OSD bug time-out default 501 = OSD bug never times out, output sync never times out
<b>X24</b>	= Executive mode status	0 = off or disabled (default) 1 = mode 1 (complete front panel lockout) 2 = mode 2 (only allow input switching and volume control)
<b>X25</b>	= Overscan	0 = 0.0% (default for RGB, HDMI) 1 = 2.5% (default for RGBcvs, YUV, S-video, and CV) 2 = 5.0%
<b>X26</b>	= Aspect ratio setting	1 = fill (default) 2 = follow
<b>X27</b>	= Screen saver mode	1 = black output (default) 2 = blue output
<b>X28</b>	= Video mute	0 = disabled 1 = enabled (mute to black) 2 = mute output video and sync
<b>X29</b>	= Auto-Image threshold value	0 - 100 (where 0 = black and 100 = white; 025 = default)
<b>X30</b>	= HDCP status	0 = no sink or source device detected 1 = sink or source detected with HDCP 2 = sink or source detected but no HDCP
<b>X31</b>	= Video switching effect	0 = cut 1 = fade through black (default)

<b>X32</b>	= HDMI output format	<p>∅ = auto (based on the display EDID: default)</p> <p>1 = DVI RGB 444</p> <p>2 = HDMI RGB "Full"</p> <p>3 = HDMI RGB "Limited"</p> <p>4 = HDMI YUV 444 "Full"</p> <p>5 = HDMI YUV 444 "Limited"</p> <p>6 = HDMI YUV 422 "Full"</p> <p>7 = HDMI YUV 422 "Limited"</p>
<b>X33</b>	= Default name	A combination of model name and the last three pairs of the device MAC address (for example, <b>IN1606-07-8C-EC</b> )
<b>X35</b>	= Audio input type	<p>∅ = none (input muted)</p> <p>1 = analog (default for inputs 1 and 2)</p> <p>2 = LPCM-2Ch digital (default for inputs 3-6)</p> <p>3 = Multi-Ch digital</p> <p>4 = LPCM-2Ch digital auto</p> <p>5 = Multi-Ch digital auto</p>
<b>X36</b>	= Video signal status	<p>∅ = video/HDMI signal not detected</p> <p>1 = video/HDMI signal detected</p>
<b>X37</b>	= Power save mode	<p>∅ = full power mode (default)</p> <p>1 = lower power state</p>
<b>X38</b>	= Screen saver status	<p>∅ = active input detected; timer not running</p> <p>1 = no active input; timer running; output sync still active</p> <p>2 = no active input; timer expired; output sync disabled</p>
<b>X39</b>	= HDCP authorization status	<p>∅ = block HDCP encryption</p> <p>1 = allow HDCP encryption (default)</p>
<b>X40</b>	= IP address	<p>xxx.xxx.xxx.xxx</p> <p>(192.168.254.254 = default)</p>
<b>X41</b>	= Subnet mask	xxx.xxx.xxx.xxx (255.255.0.0 = default)
<b>X42</b>	= Gateway address	xxx.xxx.xxx.xxx (0.0.0.0 = default)
<b>X43</b>	= Volume group number	<p>1 = program volume</p> <p>3 = mic volume</p> <p>8 = variable volume</p>
<b>X44</b>	= Group volume level	-1000 to 0, where -1000 = -100 dB or 0% volume and 0 = 0 dB or 100% volume
<b>X45</b>	= Mute group number	<p>2 = program mute</p> <p>4 = mic mute</p> <p>7 = output mute</p>
<b>X46</b>	= Bass and treble group number	<p>5 = bass control</p> <p>6 = treble control</p>
<b>X47</b>	= Bass and treble level	-240 to +120, where -240 = -24 dB and +120 = 12 dB
<b>X48</b>	= Increment value	dB value multiplied by ten, in 0.1 dB increments, to raise or lower a group fader (for example, 100 = 10 dB)
<b>X49</b>	= Password	12 digits and alphanumeric characters for user or admin passwords.
<b>NOTE:</b> / \   * and <i>space</i> are invalid characters.		
<b>X50</b>	= Verbose mode	<p>∅ = clear or none (default for Telnet connections)</p> <p>1 = verbose mode (default for RS-232)</p> <p>2 = tagged responses for queries</p> <p>3 = verbose mode and tagged for queries</p>

- X51** = Auto switch mode      Ø = disable  
 1 = prioritizes the highest numbered active input  
 2 = prioritizes the lowest numbered active input
- X52** = Video mute on all outputs      Ø = all outputs are unmuted  
 1 = at least one output is muted  
 2 = at least one output is muted and sync is disabled
- X53** = Volume knob group number      1 = program volume  
 3 = mic volume  
 8 = output volume (default)
- X54** = EDID emulation or Output rate      Ø = automatic (matches the current output resolution; default for EDID emulation only)  
 1 = output A (available for EDID export only)  
 2 = output B (available for EDID export only)  
 3 = custom EDID/output rate 1  
 4 = custom EDID/output rate 2  
 5 = custom EDID/output rate 3  
 6 = custom EDID/output rate 4  
 7 = custom EDID/output rate 5  
 8 = custom EDID/output rate 6  
 9 = output C (available for EDID export only; IN1608 models)  
 2Ø1 = custom EDID/output rate 7  
 2Ø2 = custom EDID/output rate 8

<b>SIS Variables for EDID Resolution and Refresh Rate Combinations (where X54 = 10-92)</b>									
<b>Resolution</b>	<b>23.98 Hz</b>	<b>24 Hz</b>	<b>25 Hz</b>	<b>29.97 Hz</b>	<b>30 Hz</b>	<b>50 Hz</b>	<b>59.94 Hz</b>	<b>60 Hz</b>	<b>75 Hz</b>
640x480						10		11	12
800x600						13		14	15
852x480						16		17	18
1024x768						19		20	21
1024x852						22		23	24
1024x1024						25		26	27
1280x768						28		29	30
1280x800						31		32	33
1280x1024						34		35	36
1360x765						37		38	39
1360x768						40		41	42
1365x768						43		44	45
1366x768						46		47	48
1365x1024						49		50	51
1440x900						52		53	54
1400x1050						55		56	
1600x900						57		58	
1680x1050						59		60	
1600x1200						61		62	
1920x1200						63		64	
480p							65	66	
576p						67			
720p			68	69	70	71	72	73*	
1080i						74	75	76	
1080p	77	78	79	80	81	82	83	84	
2048x1080	85	86	87	88	89	90	91	92	

\* = Default output resolution



## Command and Response Tables

Command	ASCII Command (host to scaler)	Response (scaler to host)	Additional Description								
<b>Input Switching Commands</b>											
<b>Input selection</b>											
Video and audio	[X1]!	In[X1]•A11←	Select video and audio from input [X1].								
Video only	[X1]&	In[X1]•RGB←	Select video-only from input [X1].								
Audio only	[X1]\$	In[X1]•Aud←	Select audio-only from input [X1].								
View video input	&	[X1]←	View the current video input.								
View audio input	\$	[X1]←	View the current audio input.								
View current input	!	[X1]←	View the current video and audio input.								
<p><b>NOTE:</b> Audio breakaway (\$) is not allowed to an input configured for any digital audio format.            Video breakaway (&amp;) is not allowed from an input configured for any digital audio format.            Attempting either of these invalid modes gives an E17 error.            Audio breakaway is always allowed back to the current video input.</p>											
<b>Auto switch mode</b>											
Disable auto switch mode	[Esc]∅AUSW←	Ausw∅←	Manual input switching only.								
Prioritize highest active input	[Esc]1AUSW←	Ausw1←	Automatically switches to the highest numbered active input.								
Prioritize lowest active input	[Esc]2AUSW←	Ausw2←	Automatically switches to the lowest numbered active input.								
View auto switch mode	[Esc]AUSW←	[X51]←	View the current auto switch mode.								
<p><b>NOTES:</b></p> <table> <tr> <td>[X1] = Input selection</td> <td>1 - 6 (IN1606) or 1 - 8 (IN1608 models)</td> </tr> <tr> <td>[X51] = Auto switch mode</td> <td>∅ = disable</td> </tr> <tr> <td></td> <td>1 = gives priority to the highest numbered active input</td> </tr> <tr> <td></td> <td>2 = gives priority to the lowest numbered active input</td> </tr> </table>				[X1] = Input selection	1 - 6 (IN1606) or 1 - 8 (IN1608 models)	[X51] = Auto switch mode	∅ = disable		1 = gives priority to the highest numbered active input		2 = gives priority to the lowest numbered active input
[X1] = Input selection	1 - 6 (IN1606) or 1 - 8 (IN1608 models)										
[X51] = Auto switch mode	∅ = disable										
	1 = gives priority to the highest numbered active input										
	2 = gives priority to the lowest numbered active input										

Command	ASCII Command (host to scaler)	Response (scaler to host)	Additional Description
<b>Input Configuration Commands</b>			
<b>Input video format</b>			
Set video format	[X1]*[X3]\	Typ[X1]*[X3]↵	Set input [X1] to format [X3].
View set format	[X1]\	[X3]↵	View the video format.
<b>Input EDID (VGA and HDMI)</b>			
Assign EDID to input	[Esc]A[X1]*[X54]EDID←	EdidA[X1]*[X54]↵	Assign EDID to input [X1].
View assigned EDID	[Esc]A[X1]EDID←	[X54]↵	View the EDID for input [X1].
Save an output EDID to custom slot	[Esc]S[X2]*[X54]EDID←	EdidS[X2]*[X54]↵	Save output [X2] EDID to [X54] (3-8, 201, 202).
Export EDID file	[Esc]E[X54],<filename>EDID←	EdidE[X54]↵	Export [X54] (3-8, 201, 202) EDID.
Import EDID file	[Esc]I[X54],<filename>EDID←	EdidI[X54]↵	Import [X54] (3-8, 201, 202) EDID.
<p><b>NOTE:</b> &lt;filename&gt; can optionally carry a full path name. The EDID file will be a .bin file, carrying 128 or 256 bytes of binary data.</p> <p>Exporting a default EDID table (for an [X54] value of 10 or greater) results in the HDMI LPCM-2Ch table being exported.</p>			
<b>Input name</b>			
Write input name	[Esc][X1],[X14]NI←	Nmi[X1],[X14]↵	Rename input [X1].
View input name	[Esc][X1]NI←	[X14]↵	View the name of input [X1].
<p><b>NOTE:</b> To clear an input name, enter a single space character for [X14]. This resets the input name to the default.</p>			
<b>NOTES:</b>			
[X1] = Input selection		1 - 6 (IN1606) or 1 - 8 (IN1608 models)	
[X2] = Output selection		1 = HDMI A (top) 2 = HDMI B (bottom) 3 = DTP C (IN1608 models)	
[X3] = Input video format		1 = RGB 2 = YUV 3 = RGBcvS 4 = S-video 5 = composite 6 = HDMI	
[X14] = Text label		Up to 16 characters	
[X54] = EDID emulation		See the <b>EDID table</b> on page 34.	

Command	ASCII Command (host to scaler)	Response (scaler to host)	Additional Description
<b>Auto-Image</b>			
Enable	[X1]*1A	Img[X1]*1↵	Activate Auto-Image for input [X1].
Disable	[X1]*ØA	Img[X1]*Ø↵	Turn off Auto-Image for input [X1].
View	[X1]A	[X9]↵	View the Auto-Image setting for input [X1].
Execute	A	ImgØ↵	Execute an Auto-Image for the current input (follows the aspect ratio of the current input).
Execute and fill	1*A	Img1↵	Execute an Auto-Image and fill the entire output.
Execute and follow	2*A	Img2↵	Execute an Auto-Image and maintain the aspect ratio of the current input.
<b>Auto-Image threshold value (luminosity value which the scaler defines as active video for Auto-Image)</b>			
Set value	[Esc] [X29]ALVL ↵	A1vl[X29]↵	Set the global Auto-Image luminosity to [X29].
View	[Esc]ALVL ↵	[X29]↵	View the global Auto-Image luminosity setting.
<b>Horizontal start</b>			
Specify a value	[Esc] [X4]HSRT ↵	Hsrt[X1]*[X4]↵	Set the horizontal start position.
Increment value	[Esc] +HSRT ↵	Hsrt[X1]*[X4]↵	Increase the horizontal start position.
Decrement value	[Esc] -HSRT ↵	Hsrt[X1]*[X4]↵	Decrease the horizontal start position.
View	[Esc]HSRT ↵	[X4]↵	View the horizontal start position.
<b>Vertical start</b>			
Specify a value	[Esc] [X4]VSRT ↵	Vsrt[X1]*[X4]↵	Set the vertical start position.
Increment value	[Esc] +VSRT ↵	Vsrt[X1]*[X4]↵	Increase the vertical start position.
Decrement value	[Esc] -VSRT ↵	Vsrt[X1]*[X4]↵	Decrease the vertical start position.
View	[Esc]VSRT ↵	[X4]↵	View the vertical start position.
<b>NOTES:</b>			
[X1] = Input selection		1 - 6 (IN1606) or 1 - 8 (IN1608 models)	
[X4] = H/V start		Ø - 255	
[X9] = Enable or disable		Ø = off or disabled 1 = on or enabled	
[X29] = Auto-Image threshold value		Ø - 1ØØ (where Ø = black and 1ØØ = white; 25 = default)	

Command	ASCII Command (host to scaler)	Response (scaler to host)	Additional Description
<b>Pixel phase (available only for RGB and YUV-HD input signals)</b>			
Specify a value	<b>Esc</b> <b>X5</b> PHAS ←	Phas <b>X1</b> * <b>X5</b> ↵	Set the pixel phase to <b>X5</b> on the current input.
Increment value	<b>Esc</b> +PHAS ←	Phas <b>X1</b> * <b>X5</b> ↵	Increase the pixel phase on the current input.
Decrement value	<b>Esc</b> -PHAS ←	Phas <b>X1</b> * <b>X5</b> ↵	Decrease the pixel phase on the current input.
View	<b>Esc</b> PHAS ←	<b>X5</b> ↵	View the pixel phase setting on the current input.
<b>Total pixels (available only for RGB and YUV-HD input signals)</b>			
Specify a value	<b>Esc</b> <b>X6</b> TPIX ←	Tpix <b>X1</b> * <b>X6</b> ↵	Set the total pixels to <b>X6</b> on the current input.
Increment value	<b>Esc</b> +TPIX ←	Tpix <b>X1</b> * <b>X6</b> ↵	Increase the total pixels on the current input.
Decrement value	<b>Esc</b> -TPIX ←	Tpix <b>X1</b> * <b>X6</b> ↵	Decrease the total pixels on the current input.
View	<b>Esc</b> TPIX ←	<b>X6</b> ↵	View the total pixel setting on the current input.
<b>Active pixels</b>			
Specify a value	<b>Esc</b> <b>X7</b> APIX ←	Apix <b>X1</b> * <b>X7</b> ↵	Set the active pixels to <b>X7</b> on the current input.
Increment value	<b>Esc</b> +APIX ←	Apix <b>X1</b> * <b>X7</b> ↵	Increase the active pixels on the current input.
Decrement value	<b>Esc</b> -APIX ←	Apix <b>X1</b> * <b>X7</b> ↵	Decrease the active pixels on the current input.
View	<b>Esc</b> APIX ←	<b>X7</b> ↵	View the active pixel setting on the current input.
<b>Active lines</b>			
Specify a value	<b>Esc</b> <b>X8</b> ALIN ←	Alin <b>X1</b> * <b>X8</b> ↵	Set the active lines to <b>X8</b> on the current input.
Increment value	<b>Esc</b> +ALIN ←	Alin <b>X1</b> * <b>X8</b> ↵	Increase the active lines on the current input.
Decrement value	<b>Esc</b> -ALIN ←	Alin <b>X1</b> * <b>X8</b> ↵	Decrease the active lines on the current input.
View	<b>Esc</b> ALIN ←	<b>X8</b> ↵	View the active lines setting on the current input.
<b>3:2, 2:2, 24:1 Film mode detect</b>			
Auto	<b>Esc</b> <b>X1</b> *1FILM ←	Film <b>X1</b> * <b>X12</b> ↵	Set Film mode detection to automatic (default).
Off	<b>Esc</b> <b>X1</b> *ØFILM ←	Film <b>X1</b> * <b>X12</b> ↵	Disable Film mode detection.
View setting	<b>Esc</b> <b>X1</b> FILM ←	<b>X12</b> ↵	View the current Film mode setting.

**NOTES:**

<b>X1</b> = Input selection	1 - 6 (IN1606) or 1 - 8 (IN1608 models)
<b>X5</b> = Pixel phase	Ø - 63 (31 = default)
<b>X6</b> = Total pixels	±512 of the default value
<b>X7</b> = Active pixels	±512 of the default value
<b>X8</b> = Active lines	±256 of the default value
<b>X12</b> = Film detect mode	Ø = disable 1 = auto (default)

Command	ASCII Command (host to scaler)	Response (scaler to host)	Additional Description
<b>Picture Adjustment Commands</b>			
<b>Video mute (defaults to unmuted after a power cycle)</b>			
Mute output video	<b>X2</b> *1B	Vmt <b>X2</b> *1←	Mutes video only on output <b>X2</b> .
Mute output sync/video	<b>X2</b> *2B	Vmt <b>X2</b> *2←	Mute sync and video on output <b>X2</b> .
Unmute output	<b>X2</b> *ØB	Vmt <b>X2</b> *Ø←	Unmutes the output <b>X2</b> .
View output mute status	<b>X2</b> *B	<b>X28</b> ←	View the mute status on output <b>X2</b> .
Mute video to black	1B	Vmt1←	Mutes video to black on all outputs.
Mute sync and video	2B	Vmt2←	Mutes video and sync on all outputs.
Unmute sync/video	ØB	VmtØ←	Unmutes all outputs.
View mute status on all outputs	B	<b>X52</b> ←	View the mute stats on all outputs.
<b>Color (NTSC, PAL, and SECAM inputs only)</b>			
Specify a value	<b>Esc</b> <b>X15</b> COLR←	Co1r <b>X1</b> * <b>X15</b> ←	Set the color level on the current input.
Increment value	<b>Esc</b> +COLR←	Co1r <b>X1</b> * <b>X15</b> ←	Increase the color level.
Decrement value	<b>Esc</b> -COLR←	Co1r <b>X1</b> * <b>X15</b> ←	Decrease the color level.
View	<b>Esc</b> COLR←	<b>X15</b> ←	View the color level setting.
<b>Tint (NTSC inputs only)</b>			
Specify a value	<b>Esc</b> <b>X15</b> TINT←	Tint <b>X1</b> * <b>X15</b> ←	Set the tint on the current input.
Increment value	<b>Esc</b> +TINT←	Tint <b>X1</b> * <b>X15</b> ←	Increase the tint.
Decrement value	<b>Esc</b> -TINT←	Tint <b>X1</b> * <b>X15</b> ←	Decrease the tint.
View	<b>Esc</b> TINT←	<b>X15</b> ←	View the tint setting.
<b>Contrast</b>			
Specify a value	<b>Esc</b> <b>X15</b> CONT←	Cont <b>X1</b> * <b>X15</b> ←	Set the contrast for the current input.
Increment value	<b>Esc</b> +CONT←	Cont <b>X1</b> * <b>X15</b> ←	Increase the contrast.
Decrement value	<b>Esc</b> -CONT←	Cont <b>X1</b> * <b>X15</b> ←	Decrease the contrast.
View	<b>Esc</b> CONT←	<b>X15</b> ←	View the contrast setting.
<b>Brightness</b>			
Specify a value	<b>Esc</b> <b>X15</b> BRIT←	Brit <b>X1</b> * <b>X15</b> ←	Set the brightness on the current input.
Increment value	<b>Esc</b> +BRIT←	Brit <b>X1</b> * <b>X15</b> ←	Increase the brightness.
Decrement value	<b>Esc</b> -BRIT←	Brit <b>X1</b> * <b>X15</b> ←	Decrease the brightness.
View	<b>Esc</b> BRIT←	<b>X15</b> ←	View the brightness setting.

**NOTES:**

**X1** = Input selection  
**X2** = Output selection

**X15** = Picture adjustment  
**X28** = Video mute

**X52** = Video mute on all outputs

1 - 6 (IN1606) or 1 - 8 (IN1608 models)

1 = HDMI A (top)  
2 = HDMI B (bottom)  
3 = DTP C (IN1608 models)

Ø - 127 (64 = default)

Ø = disabled  
1 = enabled (mute to black)  
2 = mute all output sync

Ø = all outputs are unmuted  
1 = at least one output is muted  
2 = at least one output is muted and sync is disabled

Command	ASCII Command (host to scaler)	Response (scaler to host)	Additional Description
<b>Detail filter</b>			
Specify a value	<b>Esc</b> <b>X15</b> HDET ←	Hdet <b>X1</b> * <b>X15</b> ↵	Set the detail filter for the current input.
Increment value	<b>Esc</b> +HDET ←	Hdet <b>X1</b> * <b>X15</b> ↵	Increase the detail.
Decrement value	<b>Esc</b> -HDET ←	Hdet <b>X1</b> * <b>X15</b> ↵	Decrease the detail.
View	<b>Esc</b> HDET ←	<b>X15</b> ↵	View the detail filter setting.
<b>Horizontal shift (image)</b>			
Specify a value	<b>Esc</b> <b>X16</b> HCTR ←	Hctr <b>X16</b> ↵	Set the horizontal start position.
Increment value	<b>Esc</b> +HCTR ←	Hctr <b>X16</b> ↵	Increase the horizontal start position.
Decrement value	<b>Esc</b> -HCTR ←	Hctr <b>X16</b> ↵	Decrease the horizontal start position.
View	<b>Esc</b> HCTR ←	<b>X16</b> ↵	View the horizontal start position setting.
<b>Vertical shift (image)</b>			
Specify a value	<b>Esc</b> <b>X17</b> VCTR ←	Vctr <b>X17</b> ↵	Set the vertical start position.
Increment value	<b>Esc</b> +VCTR ←	Vctr <b>X17</b> ↵	Increase the vertical start position.
Decrement value	<b>Esc</b> -VCTR ←	Vctr <b>X17</b> ↵	Decrease the vertical start position.
View	<b>Esc</b> VCTR ←	<b>X17</b> ↵	View the vertical start position setting.
<b>Horizontal size (image)</b>			
Specify a value	<b>Esc</b> <b>X18</b> HSIZ ←	Hsiz <b>X18</b> ↵	Set the horizontal size.
Increment value	<b>Esc</b> +HSIZ ←	Hsiz <b>X18</b> ↵	Increase the horizontal size.
Decrement value	<b>Esc</b> -HSIZ ←	Hsiz <b>X18</b> ↵	Decrease the horizontal size.
View	<b>Esc</b> HSIZ ←	<b>X18</b> ↵	View the horizontal size setting.
<b>Vertical size (image)</b>			
Specify a value	<b>Esc</b> <b>X19</b> VSIZ ←	Vsiz <b>X19</b> ↵	Set the vertical size.
Increment value	<b>Esc</b> +VSIZ ←	Vsiz <b>X19</b> ↵	Increase the vertical size.
Decrement value	<b>Esc</b> -VSIZ ←	Vsiz <b>X19</b> ↵	Decrease the vertical size.
View	<b>Esc</b> VSIZ ←	<b>X19</b> ↵	View the vertical size setting.
<b>Compound image position and size</b>			
Specify a value	<b>Esc</b> <b>X16</b> * <b>X17</b> * ... <b>X18</b> * <b>X19</b> XIMG ←	Ximg <b>X16</b> * <b>X17</b> * ... <b>X18</b> * <b>X19</b> ↵	Set the horizontal and vertical position as well as the horizontal and vertical size.
View	<b>Esc</b> XIMG ←	<b>X16</b> * <b>X17</b> * <b>X18</b> * <b>X19</b> ↵	View all position and size settings.

**NOTES:**

<b>X1</b> = Input selection	1 - 6 (IN1606) or 1 - 8 (IN1608 models)
<b>X15</b> = Picture adjustment	0 - 127 (64 = default)
<b>X16</b> = Horizontal position	±2048
<b>X17</b> = Vertical position	±1200
<b>X18</b> = Horizontal size	0 - 4096
<b>X19</b> = Vertical size	0 - 2400

Command	ASCII Command (host to scaler)	Response (scaler to host)	Additional Description
<b>Output Configuration Commands</b>			
<b>Output scaler rate</b>			
Set output rate	<b>[Esc]</b> <b>[X54]</b> RATE ←	Rate <b>[X54]</b> ↵	Set the output rate to <b>[X54]</b> .
View output rate	<b>[Esc]</b> RATE ←	<b>[X54]</b> ↵	View the selected output rate.
<b>HDMI output format</b>			
Set format	<b>[Esc]</b> <b>[X2]</b> * <b>[X32]</b> VTPO ←	Vtpo <b>[X2]</b> * <b>[X32]</b> ↵	Set the color space and format.
View setting	<b>[Esc]</b> <b>[X2]</b> VTPO ←	<b>[X32]</b> ↵	View the color space and format setting.
<b>Power save mode</b>			
Power save off	<b>[Esc]</b> ∅PSAV ←	Psav∅ ↵	Operate at full power.
Power save on	<b>[Esc]</b> 1PSAV ←	Psav1 ↵	Operate in a low power state. No video output.
View setting	<b>[Esc]</b> PSAV ←	<b>[X37]</b> ↵	View the power mode.
<b>Screen saver</b>			
Set mode	<b>[Esc]</b> M <b>[X27]</b> SSAV ←	SsavM <b>[X27]</b> ↵	Set the color of the screen saver.
View mode	<b>[Esc]</b> MSSAV ←	<b>[X27]</b> ↵	View the color of the screen saver.
Set time-out duration	<b>[Esc]</b> T <b>[X23]</b> SSAV ←	SsavT <b>[X23]</b> ↵	Set the time-out duration.
View time-out duration	<b>[Esc]</b> TSSAV ←	<b>[X23]</b> ↵	View the time-out duration.
View screen saver status	<b>[Esc]</b> SSSAV ←	<b>[X38]</b> ↵	View the screen saver status.

**NOTES:**

**[X2]** = Output selection

**[X23]** = Output sync timeout

**[X27]** = Screen saver mode

**[X32]** = HDMI output format

**[X37]** = Power save mode

**[X38]** = Screen saver status

**[X54]** = Output rate

1 = HDMI A (top)  
2 = HDMI B (bottom)  
3 = DTP C (IN1608 models)  
∅ = Output sync is instantly disabled with no active input  
1-50∅ (in 1 second increments)  
501 = Output sync never times out  
1 = black output (default)  
2 = blue output  
∅ = auto (default)  
1 = DVI RGB 444  
2 = HDMI RGB "Full"  
3 = HDMI RGB "Limited"  
4 = HDMI YUV 444 "Full"  
5 = HDMI YUV 444 "Limited"  
6 = HDMI YUV 422 "Full"  
7 = HDMI YUV 422 "Limited"  
∅ = full power mode (default)  
1 = low power state  
∅ = active input detected; timer not running  
1 = no active input; timer running; output sync enabled  
2 = no active input; timer expired; output sync disabled  
See the [Output Rate table](#) on page 34.

Command	ASCII Command (host to scaler)	Response (scaler to host)	Additional Description
<b>Audio Configuration Commands</b>			
<b>Audio input format</b>			
Set none	<b>[Esc] I [X1] *0AFMT ←</b>	AfmtI [X1] *0 ←	Mutes all audio for input [X1]. Sets “No Audio” EDID.
Set analog	<b>[Esc] I [X1] *1AFMT ←</b>	AfmtI [X1] *1 ←	Set the audio to analog. Sets “No Audio” EDID.
Set LPCM-2Ch	<b>[Esc] I [X1] *2AFMT ←</b>	AfmtI [X1] *2 ←	Set the audio to LPCM-2Ch digital. Sets 2Ch audio EDID. (HDMI or DTP inputs only).
Set Multi-Ch	<b>[Esc] I [X1] *3AFMT ←</b>	AfmtI [X1] *3 ←	Set the audio to Multi-Ch digital. Sets Multi-Ch audio EDID. (HDMI or DTP inputs only).
Set to LPCM-2Ch auto	<b>[Esc] I [X1] *4AFMT ←</b>	AfmtI [X1] *4 ←	Set the audio to automatically prioritize digital. Analog audio is set when LPCM-2Ch is not available. Sets 2Ch audio EDID.
Set to Mutli-Ch auto	<b>[Esc] I [X1] *5AFMT ←</b>	AfmtI [X1] *5 ←	Set the audio to automatically prioritize digital. Analog audio is set when Multi-Ch is not available. Sets Multi-Ch audio EDID.
View	<b>[Esc] I [X1] AFMT ←</b>	[X35] ←	View the audio input format.
<b>Volume knob assignment</b>			
Set volume knob group	<b>[Esc] 1 * [X53] KNOB ←</b>	Knob1 * [X53] ←	Set the front panel Volume knob value to affect group [X53].
View volume knob group	<b>[Esc] 1 KNOB ←</b>	[X53] ←	View the volume knob group.
<b>Group volume</b>			
Set volume	<b>[Esc] D [X43] * [X44] GRPM ←</b>	GrpmD [X43] * [X44] ←	Set the volume to a value of [X44].
Raise volume	<b>[Esc] D [X43] * [X48] +GRPM ←</b>	GrpmD [X43] * [X44] ←	Increase the volume by [X48] dB.
Lower volume	<b>[Esc] D [X43] * [X48] -GRPM ←</b>	GrpmD [X43] * [X44] ←	Decrease the volume by [X48] dB.
View volume level	<b>[Esc] D [X43] GRPM ←</b>	[X44] ←	View the volume level.

**NOTES:**

[X1] = Input selection

[X35] = Audio input format

[X43] = Volume group number

[X44] = Group volume level

[X48] = Increment value

[X53] = Volume knob group number

1 - 6 (IN1606) or 1 - 8 (IN1608 models)

0 = none (input muted)

1 = analog (default for inputs 1 and 2)

2 = LPCM-2Ch (default for inputs 3-6)

3 = Multi-Ch

4 = LPCM-2Ch auto

5 = Multi-Ch auto

1 = program volume

3 = mic volume

8 = variable volume

-1000 to 0, where -1000 = -100 dB or 0% volume and

0 = 0 dB or 100% volume

dB value multiplied by ten, in 0.1 dB increments, to raise or lower a group fader (for example, 100 = 10 dB)

1 = program volume

3 = mic volume

8 = output volume (default)



Command	ASCII Command (host to scaler)	Response (scaler to host)	Additional Description
<b>Group mute</b>			
Group mute	<b>Esc</b> D <b>X45</b> *1GRPM ←	GrpmD <b>X45</b> *1 ←	Mute group <b>X45</b> .
Group unmute	<b>Esc</b> D <b>X45</b> *ØGRPM ←	GrpmD <b>X45</b> *Ø ←	Unmute group <b>X45</b> .
View group mute status	<b>Esc</b> D <b>X45</b> GRPM ←	<b>X9</b> ←	
<b>Group bass and treble</b>			
Set bass or treble level	<b>Esc</b> D <b>X46</b> * <b>X47</b> GRPM ←	GrpmD <b>X46</b> * <b>X47</b> ←	Set the bass or treble to a value of <b>X47</b> .
Raise bass or treble	<b>Esc</b> D <b>X46</b> * <b>X48</b> +GRPM ←	GrpmD <b>X46</b> * <b>X47</b> ←	Increase the volume by <b>X48</b> dB.
Lower bass or treble	<b>Esc</b> D <b>X46</b> * <b>X48</b> -GRPM ←	GrpmD <b>X46</b> * <b>X47</b> ←	Decrease the volume by <b>X48</b> dB.
View bass or treble level	<b>Esc</b> D <b>X46</b> GRPM ←	<b>X47</b> ←	

**NOTES:**

**X9** = Enable or disable

**X45** = Mute group number

**X46** = Bass and treble group number

**X47** = Group bass and treble level

**X48** = Increment value

Ø = off or disabled

1 = on or enabled

2 = program mute

4 = mic mute

7 = output mute

5 = bass control

6 = treble control

-24Ø to +12Ø, where -24Ø = -24 dB and 12Ø = 12 dB

dB value multiplied by ten, in 0.1 dB increments, to raise or lower a group fader (for example, 1ØØ = 10 dB)

Command	ASCII Command (host to scaler)	Response (scaler to host)	Additional Description
<b>Preset Commands</b>			
<b>User presets</b>			
Recall preset	1 * <u>X21</u> .	1Rpr <u>X21</u> ↵	Recall user preset <u>X21</u> .
Save preset	1 * <u>X21</u> ,	1Spr <u>X21</u> ↵	Save the current picture controls.
Delete preset	[Esc] X1 * <u>X21</u> PRST ←	PrstX1 * <u>X21</u> ↵	Clear user preset <u>X21</u> .
<b>User preset name</b>			
Write name	[Esc] 1 * <u>X21</u> , <u>X14</u> PNAM ←	Pnam1 * <u>X21</u> , <u>X14</u> ↵	Set user preset <u>X21</u> name to <u>X14</u> .
View name	[Esc] 1 * <u>X21</u> PNAM ←	<u>X14</u> ↵	View the name of user preset <u>X21</u> .
<b>NOTE:</b> To clear a user preset name, enter a single space character for <u>X14</u> . This resets the user preset name to the default value, “[User Preset XX].” This is valid only for existing presets.			
<b>Input presets</b>			
Recall preset	2 * <u>X22</u> .	2Rpr <u>X22</u> ↵	Recall input preset <u>X22</u> .
Save preset	2 * <u>X22</u> ,	2Spr <u>X22</u> ↵	See the table below for settings saved on input presets.
Delete preset	[Esc] X2 * <u>X22</u> PRST ←	PrstX2 * <u>X22</u> ↵	Clear input preset <u>X22</u> .
<b>Input preset name</b>			
Write name	[Esc] 2 * <u>X22</u> , <u>X14</u> PNAM ←	Pnam2 * <u>X22</u> , <u>X14</u> ↵	Set input preset <u>X22</u> name to <u>X14</u> .
View name	[Esc] 2 * <u>X22</u> PNAM ←	<u>X14</u> ↵	View the name of user preset <u>X22</u> .
<b>NOTE:</b> To clear an input preset name, enter a single space character for <u>X14</u> . This resets the input preset name to the default value, “[Input Preset XXX].” This is valid only for existing presets.			
<b>Auto memories (per input)</b>			
Enable	[Esc] <u>X1</u> * 1AMEM ←	Amem <u>X1</u> * 1 ↵	Enable Auto memory on input <u>X1</u> .
Disable	[Esc] <u>X1</u> * 0AMEM ←	Amem <u>X1</u> * 0 ↵	Disable Auto memory on input <u>X1</u> .
<b>Input preset availability</b>			
Query input preset availability	51 #	<u>X9</u> <sup>1</sup> <u>X9</u> <sup>2</sup> ... <u>X9</u> <sup>128</sup> ↵ PreI <u>X9</u> <sup>1</sup> <u>X9</u> <sup>2</sup> ... <u>X9</u> <sup>128</sup> ↵	Verbose mode 2 and 3
Query user preset availability	52 * <u>X1</u> #	<u>X9</u> <sup>1</sup> <u>X9</u> <sup>2</sup> ... <u>X9</u> <sup>16</sup> ↵ PreU <u>X1</u> * <u>X9</u> <sup>1</sup> <u>X9</u> <sup>2</sup> ... <u>X9</u> <sup>16</sup> ↵	Verbose mode 2 and 3
<b>NOTES:</b>			
<u>X1</u> = Input selection		1 - 6 (IN1606) or 1 - 8 (IN1608 models)	
<u>X9</u> = Assigned or unassigned		0 = disabled or unassigned 1 = enabled or assigned	
<u>X14</u> = Text label		Up to 16 characters	
<u>X21</u> = User presets		1 - 16	
<u>X22</u> = Input presets		1 - 128	

Saved Settings for User Presets		Saved Settings for Input Presets			
Color	Detail	Input Type	Contrast	V Start	Image H/V Position
Tint	Preset Name	Preset Name	Brightness	H Active	Image H/V Size
Contrast	Image H/V Position	Audio Gain/Attenuation	Detail	V Active	
Brightness	Image H/V Size	Color	Total Pixels	Phase	
		Tint	H Start	Film Mode	

Command	ASCII Command (host to scaler)	Response (scaler to host)	Additional Description
<b>Advanced Configuration Commands</b>			
<b>Test pattern</b>			
Set pattern	<b>Esc</b> <b>X20</b> TEST ←	Test <b>X20</b> ↵	Set a test pattern.
View test pattern	<b>Esc</b> TEST ←	<b>X20</b> ↵	View the current test pattern.
<b>Freeze</b>			
Enable	1F	Frz1 ↵	Freeze the current input.
Disable	∅F	Frz∅ ↵	Unfreeze the current input.
View	F	<b>X9</b> ↵	View the freeze setting.
<b>Video switch effect</b>			
Cut	<b>Esc</b> ∅SWEF ←	Swef∅ ↵	Set the switch effect to cut.
Fade through black	<b>Esc</b> 1SWEF ←	Swef1 ↵	Set the switch effect to fade through black (default).
View setting	<b>Esc</b> SWEF ←	<b>X31</b> ↵	View the switch effect setting.
<b>Input aspect ratio (per input)</b>			
Set for fill	<b>Esc</b> <b>X1</b> *1ASPR ←	Aspr <b>X1</b> *1 ↵	Fill the entire output.
Set to follow	<b>Esc</b> <b>X1</b> *2ASPR ←	Aspr <b>X1</b> *2 ↵	Maintain the input aspect ratio.
View aspect setting	<b>Esc</b> <b>X1</b> ASPR ←	<b>X26</b> ↵	View the aspect ratio setting.
<b>Executive mode</b>			
Enable mode 1	1X	Exe1 ↵	Lock the entire front panel.
Enable mode 2	2X	Exe2 ↵	Limit front panel control to input switching and volume control only.
Disable	∅X	Exe∅ ↵	Unlock the front panel.
View status	X	<b>X24</b> ↵	View the executive mode.

**NOTES:**

<b>X1</b> = Input selection	1 - 6 (IN1606) or 1 - 8 (IN1608 models)
<b>X9</b> = Enable or disable	∅ = off or disable 1 = on or enable
<b>X20</b> = Test patterns	∅ = none (default) 1 = crop 2 = alternating pixels 3 = color bars 4 = grayscale 5 = blue mode 6 = audio test pattern (pink noise)
<b>X24</b> = Executive mode status	∅ = off or disabled (default) 1 = mode 1 (complete front panel lockout) 2 = mode 2 (input selection and volume control only)
<b>X26</b> = Aspect ratio setting	1 = fill (default) 2 = follow
<b>X31</b> = Video switching effect	∅ = cut 1 = fade through black (default)

Command	ASCII Command (host to scaler)	Response (scaler to host)	Additional Description
<b>Overscan mode (applies only to SMPTE input resolutions)</b>			
Set value	<b>[Esc]</b> <b>[X3]</b> * <b>[X25]</b> OSCN ←	0scn <b>[X3]</b> * <b>[X25]</b> ←	Set the overscan value.
View status	<b>[Esc]</b> <b>[X3]</b> OSCN ←	<b>[X25]</b> ←	View the overscan setting.
<b>HDCP notification (displayed on non-HDCP displays with HDCP input selected)</b>			
Enable notification	<b>[Esc]</b> N1HDCP ←	HdcpN1 ←	Displays a green screen.
Disable notification	<b>[Esc]</b> N0HDCP ←	HdcpN0 ←	Mutes output to black.
Query notification	<b>[Esc]</b> NHDCP ←	<b>[X9]</b> ←	View the HDCP notification setting.
<b>HDCP status</b>			
Query input	<b>[Esc]</b> I <b>[X1]</b> HDCP ←	<b>[X30]</b> ← HdcpI <b>[X1]</b> * <b>[X30]</b> ←	View the HDCP status on input <b>[X1]</b> (inputs 3+ only). Verbose mode 2 and 3
Query output	<b>[Esc]</b> O <b>[X2]</b> HDCP ←	<b>[X30]</b> ← HdcpO <b>[X2]</b> * <b>[X30]</b> ←	View the HDCP status on output <b>[X2]</b> . Verbose mode 2 and 3
<b>HDCP authorized setting (valid for HDMI inputs only, to allow or block HDCP input signals)</b>			
Enable HDCP authorization	<b>[Esc]</b> E <b>[X1]</b> * 1HDCP ←	HdcpE <b>[X1]</b> * 1 ←	Enable HDCP authorization (inputs 3+ only).
Disable HDCP authorization	<b>[Esc]</b> E <b>[X1]</b> * 0HDCP ←	HdcpE <b>[X1]</b> * 0 ←	Disable HDCP authorization (inputs 3+ only).
Query HDCP authorization status	<b>[Esc]</b> E <b>[X1]</b> HDCP ←	<b>[X39]</b> ←	View HDCP authorization setting (inputs 3+ only).
<b>Video signal presence</b>			
View video signal presence status	<b>[Esc]</b> 0LS ←	<b>[X36]</b> * <b>[X36]</b> * ... <b>[X36]</b> * <b>[X36]</b> ← In00 • <b>[X36]</b> * <b>[X36]</b> * ... <b>[X36]</b> * <b>[X36]</b> * <b>[X36]</b> ←	View video signal presence setting for all inputs. Verbose mode 2 and 3

**NOTES:**

- [X1]** = Input selection  
1 - 6 (IN1606) or 1 - 8 (IN1608 models)
- [X2]** = Output selection  
1 = HDMI A (top)  
2 = HDMI B (bottom)  
3 = DTP C (IN1608 models)
- [X3]** = Input video format  
1 = RGB  
2 = YUV  
3 = RGBcvs  
4 = S-video  
5 = Composite  
6 = HDMI
- [X9]** = Enable or disable  
0 = off or disabled  
1 = on or enabled
- [X25]** = Overscan  
0 = 0.0% (default for RGB and HDMI)  
1 = 2.5% (default for YUV, RGBcvs, S-Video, and CV)  
2 = 5.0%
- [X30]** = HDCP status  
0 = no sink or source device detected  
1 = sink or source detected with HDCP  
2 = sink or source detected but no HDCP is present
- [X36]** = Video signal status  
0 = video/HDMI signal not detected  
1 = video/HDMI signal detected
- [X39]** = HDMI input HDCP authorization status  
0 = block HDCP encryption  
1 = allow HDCP encryption (default)

Command	ASCII Command (host to scaler)	Response (scaler to host)	Additional Description
<b>Device Commands</b>			
<b>On-screen input “bug” time-out</b>			
<b>NOTE:</b> The OSD bug is displayed after selecting a new input.			
Set OSD bug time-out	<b>[Esc]</b> <b>X23</b> MDUR ←	Mdur <b>X23</b> ↵	Set the OSD time-out duration to <b>X23</b> seconds (003 = default).
View time-out	<b>[Esc]</b> MDUR ←	<b>X23</b> ↵	View the OSD time-out duration.
<b>NOTE:</b> Setting the time-out to 501 permanently displays the OSD bug (never times out). Setting the time-out to 0 disables the OSD bug.			
<b>Reset</b>			
Erase user-supplied web pages and files <sup>24 28</sup>	<b>[Esc]</b> <i>filename</i> EF ←	Del • <i>filename</i> ↵	Delete imported web pages and files.
Erase current directory and files <sup>24 28</sup>	<b>[Esc]</b> / EF ←	Dd1 ↵	Delete the current directory and files.
Erase current directory and subdirectories <sup>24 28</sup>	<b>[Esc]</b> // EF ←	Dd1 ↵	Delete the current directory and subdirectories.
Erase flash memory <sup>24</sup>	<b>[Esc]</b> ZFFF ←	Zpf ↵	Clear the flash memory.
Reset all device settings to factory default <sup>24</sup>	<b>[Esc]</b> ZXXX ←	Zpx ↵	Reset all device settings to factory default.
Absolute system reset <sup>24</sup> (includes setting DHCP: off; IP 192.168.254.254)	<b>[Esc]</b> ZQQQ ←	Zpq ↵	Reset all device settings, including DHCP and IP settings.
Absolute system reset <sup>24</sup> (retain IP)	<b>[Esc]</b> ZY ←	Zpy ↵	Reset all device settings, excluding IP settings.
<b>NOTE:</b> The reset <b>[Esc]</b> ZY is similar to ZQQQ, but excludes IP settings such as IP address, subnet mask, gateway IP address, unit name, DHCP setting, and port mapping (telnet, web, or direct access) in order to maintain communications with the device. This reset is recommended after a firmware update.			
<b>NOTES:</b>			
<b>X23</b> = On-screen display bug time-out		0 = OSD bug is never displayed	
		1 - 500 (in 1 second increments)	
		3 = default	
		501 = OSD bug never times out	

Command	ASCII Command (host to scaler)	Response (scaler to host)	Additional Description
<b>Information request</b>			
General Information	I	Vid[X1]•Aud[X1]•Typ[X3]•Std[X10]•Blk[X28]•... Hrt[X13]•Vrt[X13]↵	
Query firmware version	Q	x.xx↵	View firmware version.
Query full firmware version	*Q	x.xx.xxxx↵	View full firmware version.
Query part number	N	<part number>↵	View the device part number.
View internal temperature	[Esc]2ØSTAT↵	[X11]↵	View the temperature in degrees Celsius.
<b>Backup or restore configuration</b>			
Save box configuration to file system	[Esc]1*{config type}XF↵	Cfg1*{config type}↵	Backup device configuration.
Restore box configuration from file system	[Esc]Ø*{config type}XF↵	CfgØ*{config type}↵	Restore device configuration.
<b>NOTE:</b> {config type} = Ø = IP config, 2 = box-specific parameters.			
<b>Device naming</b>			
Set unit name <sup>24</sup>	[Esc][X14]CN↵	Ipn•[X14]↵	Set the device name to [X14].
Set unit name to factory default <sup>24</sup>	[Esc]•CN↵	Ipn•[X33]↵	Reset the device name to the factory default.
View unit name	[Esc]CN↵	[X14]↵	View the device name.

**NOTES:**

- [X1] = Input selection  
1 - 6 (IN1606) or 1 - 8 (IN1608 models)
- [X3] = Input video format  
1 = RGB  
2 = YUV  
3 = RGBcvS  
4 = S-video  
5 = composite  
6 = HDMI
- [X10] = Input standard  
Ø = no signal detected on the current input  
1 = NTSC 3.85  
2 = PAL  
3 = NTSC 4.43  
4 = SECAM  
- = not applicable (occurs when the input is active RGB, YUV, or HDMI signals)
- [X11] = Internal temperature  
In degrees Celsius
- [X13] = Horizontal and vertical frequencies  
xxx.x
- [X14] = Text label  
Up to 63 characters
- [X28] = Video mute  
Ø = off or disabled  
1 = on or enabled (mute to black)  
2 = mute all output sync
- [X33] = Default name  
A combination of model name and the last 3 pairs of the MAC address

Command	ASCII Command (host to scaler)	Response (scaler to host)	Additional Description
<b>IP Control Port Commands</b>			
<b>IP setup</b>			
<b>NOTE:</b> Changes made to any TCP/IP settings do not take effect until the reboot networking command ( <b>Esc</b> 2B00T ←) is issued.			
Set IP address <sup>24</sup>	<b>Esc</b> X40 CI ←	Ipi • X40 ←	Set the IP address.
Read IP address <sup>24</sup>	<b>Esc</b> CI ←	X40 ←	View the current IP address.
Set DHCP mode	<b>Esc</b> X9 DH ←	I dh X9 ←	Set the DHCP mode.
View DHCP mode	<b>Esc</b> DH ←	X9 ←	View the DHCP mode setting.
Set subnet mask <sup>24</sup>	<b>Esc</b> X41 CS ←	Ips • X41 ←	Set the subnet mask.
View subnet mask	<b>Esc</b> CS ←	X41 ←	View the subnet mask setting.
Set gateway IP address <sup>24</sup>	<b>Esc</b> X42 CG ←	Ipg • X42 ←	Set the gateway IP address.
View gateway IP address	<b>Esc</b> CG ←	X42 ←	View the gateway IP address setting.
Reboot networking	<b>Esc</b> 2B00T ←	Boot2 ←	Restarts the network after IP setting or DHCP changes.
<b>NOTE:</b> Changes to IP or DHCP settings will not take effect until the <b>Esc</b> 2B00T ← command is executed.			
<b>Passwords</b>			
<b>NOTE:</b> Passwords may be hidden (for example, *****) on certain host devices.			
Set administrator password	<b>Esc</b> X49 CA ←	Ipa • X49 ←	Set the administrator password.
Read administrator password	<b>Esc</b> CA ←	X49 ←	View the administrator password.
Reset (clear) administrator password	<b>Esc</b> • CA ←	Ipa • ←	Reset or clear the administrator password.
Set user password	<b>Esc</b> X49 CU ←	Ipu • X49 ←	Set the user password.
Read user password	<b>Esc</b> CU ←	X49 ←	View the user password.
Reset (clear) user password	<b>Esc</b> • CU ←	Ipu • ←	Reset or clear the user password.
<b>Verbose mode</b>			
Set verbose mode	<b>Esc</b> X50 CV ←	Vrb X50 ←	Enable or disable verbose mode and tagged responses, where additional information is provided in response to a query.
View verbose mode	<b>Esc</b> CV ←	X50 ←	View the verbose mode.
<b>NOTES:</b>			
X9 = Enable or disable		Ø = off or disabled 1 = on or enabled	
X40 = IP address		xxx . xxx . xxx . xxx (192 . 168 . 254 . 254 = default)	
X41 = Subnet mask		xxx . xxx . xxx . xxx (255 . 255 . 0 . 0 = default)	
X42 = Gateway address		xxx . xxx . xxx . xxx (0 . 0 . 0 . 0 = default)	
X49 = Password		12 digits and alphanumeric characters (no / \   * or space)	
X50 = Verbose mode		Ø = clear or none (default for Telnet connections) 1 = verbose mode (default for RS-232 connections) 2 = tagged responses for queries 3 = verbose mode and tagged queries	

# Configuration Software

The Extron Product Configuration Software (PCS) offers another way to control the scalers via USB, RS-232, or TCP/IP connection in addition to the SIS commands.

This section describes the software installation and communication (see [Internal Web Pages](#) on page 56 or refer to the *IN1606 and IN1608 Series Product Configuration Software* help file for detailed control information). Topics in this section include:

- [Installing the Software](#)
- [Starting the Software](#)
- [Using the Software](#)

The graphical interface includes the same functions as those on the device front panel with additional features that are only available through the software.

The control software is compatible with Microsoft Windows operating systems. The software program is available on the Extron website ([www.extron.com](http://www.extron.com)).

## Installing the Software

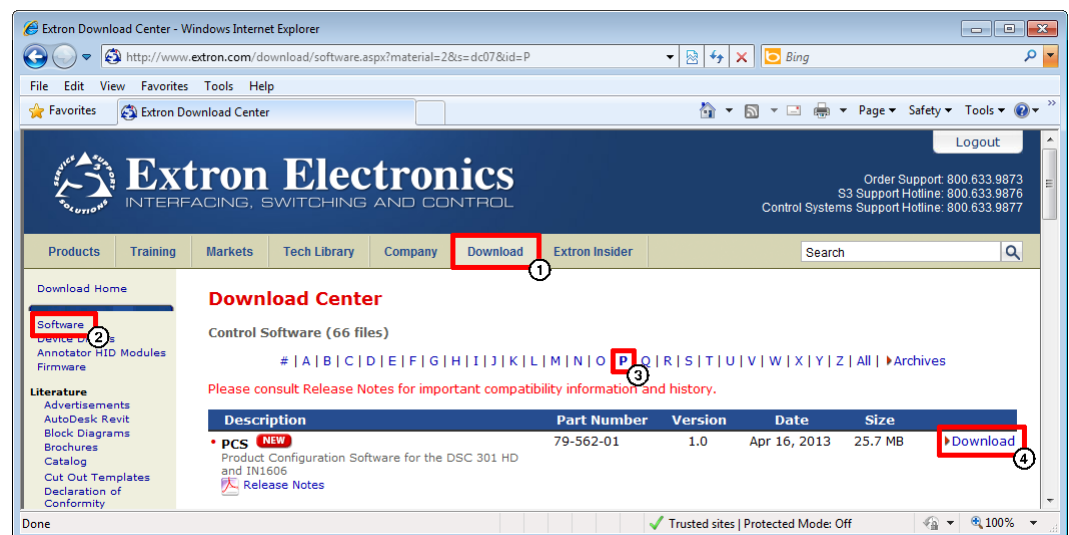

**Figure 24. PCS Download from the Extron Website**

1. On the Extron website ([www.extron.com](http://www.extron.com)), select the **Download** tab.
2. On the Download Center screen, select **Software** from the left sidebar menu.
3. Click the **P** link to locate the Product Configuration Software.
4. Click the **Download** link to the right of the PCS description.
5. Follow the on-screen instructions to download the program to your PC.



## Starting the Software

Open the Product Configuration Software program from the Start menu or desktop shortcut. The Extron Product Configuration Software window opens with a new device tab open. Connect to the scaler with one of the tabs on the left side of the window.

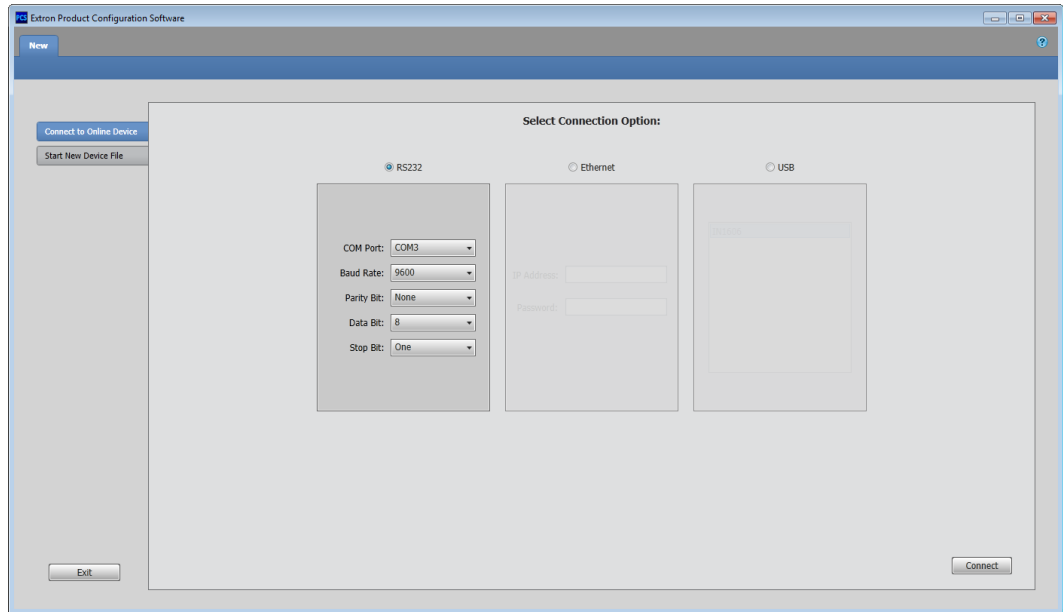

Figure 25. Device Selection Window

### Connect to Online Device Tab

The **Connect to the Online Device** tab connects the software to a specified device.

1. Click the **Connect to Online Device** tab.
2. Choose one of the following radio buttons to choose the connection method to the scaler:
  - **RS232** — Select the desired protocol from the **COM Port** and **Baud Rate** drop-down menus.
  - **Ethernet** — From the **IP Address** field, enter the IP address or hostname of the desired scaler.

**NOTE:** If the desired scaler is password-protected, enter the password in the **Password** field.

- **USB** — Select the desired device from the list of connected devices.
3. Click the **Connect** button. The device tab opens the configuration pages in live mode is ready for configuration.

### Start New Device File Tab

The **Start New Device File** tab opens configuration pages in emulation mode. In emulation mode, no connection is made to a device and many features are unavailable.

1. Click the **Start New Device File** tab.
2. Select the scaler in one of the following methods:
  - Select the scaler from the **Device Selection** field.

**NOTE:** Use the **Device Filters** drop-down menus to narrow the list of devices in the Device Selection section.

- In the **Device Name** field, enter the name of the device.
3. Click the **Open Device** button. A tab for the scaler opens in Emulation mode (see **Connect** on page 53 to connect to a device).

## Using the Software

**NOTE:** For general software navigation, see [Internal Web Pages](#) on page 56 or open the *IN1606 and IN1608 Series Product Configuration Software Help* file.

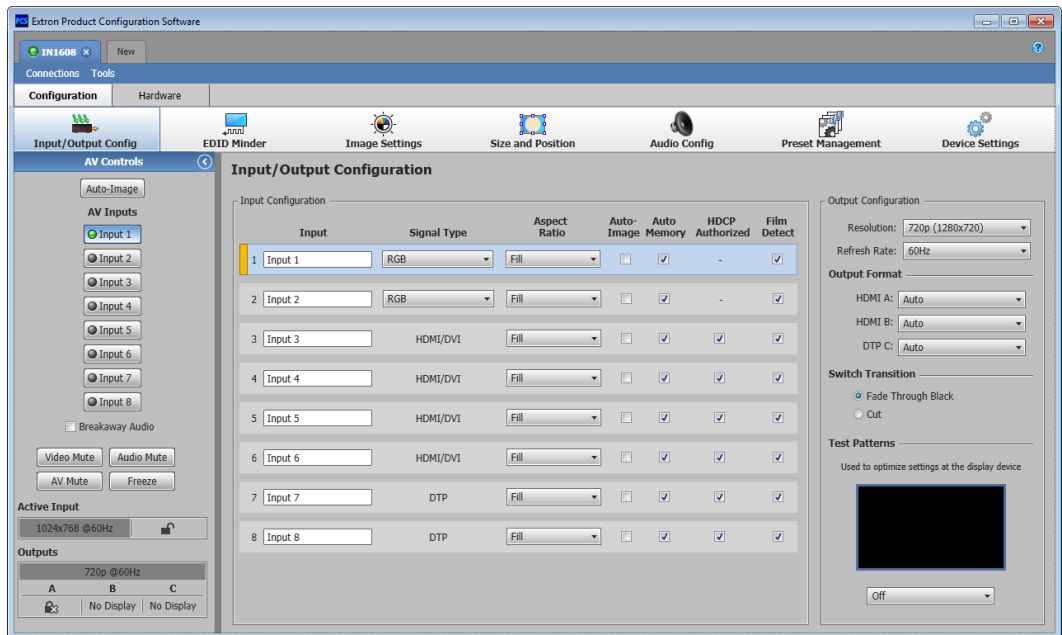
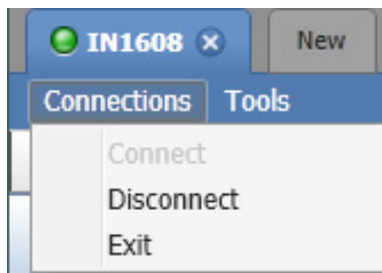

**Figure 26. New Device Page in Live Mode (IN1608)**

Under the device tab, the PCS has two unique drop-down menus: Connections and Tools (see the rest of this section for information about these features or see [Internal Web Pages](#) on page 57 for information on configuring a connected device).

## Connections Menu

The Connections menu contains options for connecting, disconnecting, and exiting the program. To access the menu, click the **Connections** menu below the device tab.



**Figure 27. Connections Menu (IN1608)**

## Connect

This option connects a device tab in emulation mode to a device. The page goes from emulation mode to live mode. Current device settings are displayed. The tab indicator changes from gray (not connected) to green (connected).

**NOTE:** If a device is already connected, the **Connect** option is disabled until the device is disconnected or the connection times out.

1. From the **Connections** menu, select **Connect**. The Connection Settings window opens (shown at right).
2. Select the connection method from the list of radio buttons.

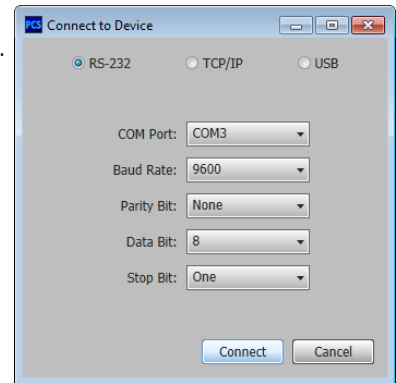

- Select the **TCP/IP** radio button if the device is connected to the host device through a LAN or WAN.

Enter the device IP address or hostname in the **IP Address** field. If the device is password-protected, enter the password in the **Password** field.

- Select the **RS-232** radio button if the device is connected to the host device through an RS-232 connection.

Select the desired values from the **COM Port** and **Baud Rate** drop-down menus.

**NOTE:** The default baud rate is 9600 baud.

- Select the **USB** radio button if the device is connected to the host device through the front panel mini-USB connector. Select the device from the list of devices.

3. Click the **OK** button to connect to the device.

## Disconnect

This option disconnects the PCS program from the connected device and returns it to emulation mode.

From the **Connections** menu, select **Disconnect**. The scaler tab enters Emulation mode.

**NOTE:** If a device is already disconnected, the **Disconnect** option is disabled until the device is connected.

## Exit

This option disconnects the scaler from the software and closes the application.

From the **Connections** menu, select **Exit**. The application closes.

## Tools Menu

The Tools menu contains options backing up and restoring program settings, updating firmware, viewing and saving communication data, and resetting confirmation dialog boxes. To access this menu, click the **Tools** menu.

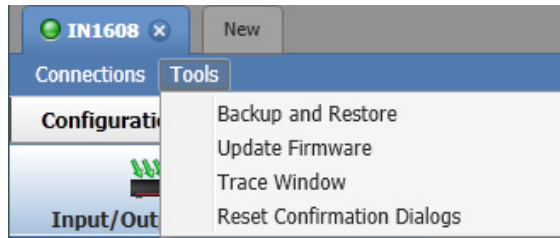

Figure 28. Tools Menu (IN1608)

## Backup and Restore

This option saves current configurations and restores saved configurations.

From the **Tools** menu, click **Backup and Restore**. The System Backup and Restore window opens.

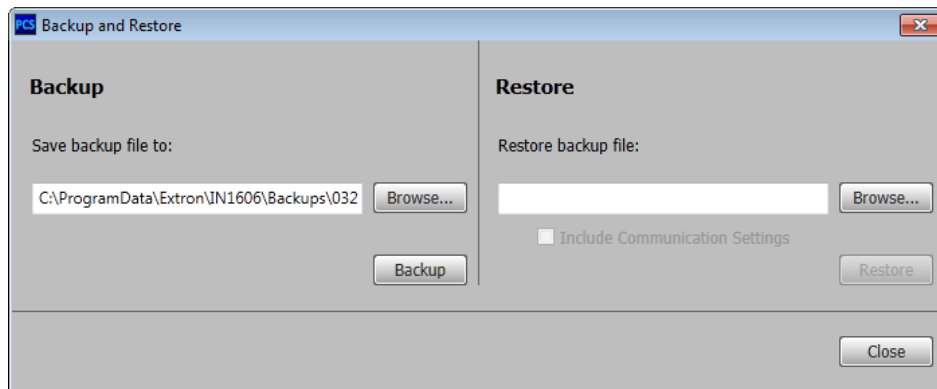

Figure 29. Backup and Restore Window

### To save the current configuration settings to an external file:

1. In the Backup panel, click the **Browse** button. The Save As window opens.
2. Navigate to the desired save location on the host device and click the **Save** button. The window closes.
3. Click the **Backup** button to save an external file to the host device.
4. Click the **Close** button to close the System Backup and Restore window.

### To restore a saved configuration settings file:

1. In the Restore panel, click the Browse button. The Open window opens.
2. Navigate the save location of the saved file and click the **Open** button. The Open window closes.

**NOTE:** Valid files have a .extz file extension.

3. If desired, select the **Include Communication Settings** check box to also include communication settings to the restored configuration.
4. Click the **Restore** button to apply the saved configuration settings.
5. Click the **Close** button to close the System Backup and Restore window.

## Update Firmware

This option uploads firmware from the host device to the connected device.

**NOTE:** If necessary, download new firmware from the Extron website (see [Downloading Updated Firmware](#) on page 88).

1. From the **Tools** menu, select **Update Firmware**. A dialog box opens to ask permission to disconnect from the device.
2. Click the **Continue** button to disconnect from the device and continue with the firmware update process. The Update Firmware dialog box opens.
3. Click the **Browse** button.
4. Navigate to the desired firmware file and select the device-specific firmware file. Valid firmware files have an .eff or .esf file extension.
5. Click the **Open** button. This returns you to the Update Firmware dialog box.
6. In the Update Firmware dialog box, click **Upload**. The progress bar shows the progress of the firmware upload to the device.

## Trace Window

This option displays the data sent to and from the device in a separate window for debugging purposes.

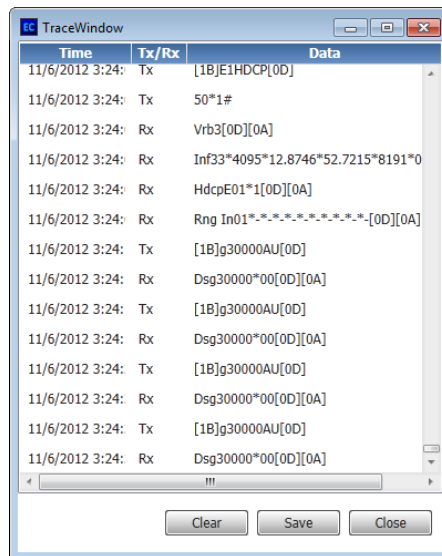

**Figure 30. Trace Window**

From the **Tools** menu, select **Trace Window**. The Trace Window window opens.

- Click the **Clear** button to erase the displayed data in the window.
- Click the **Save** button to save the displayed data in XML format.

## Reset Confirmation Dialogs

This option resets all disabled confirmation dialogs to the default settings.

1. From the **Tools** menu, select **Reset Confirmation Dialogs**. A dialog box opens.
2. Click the **Reset** button.

# Internal Web Pages

The scalers feature an on-board web server, displayed as a set of internal web pages. These pages allow for control and operation of the scaler through a LAN or WAN connection. Use a web browser to view the pages on a PC connected to the scaler.

**NOTE:** The scaler internal Web pages do not support compatibility mode in Microsoft® Internet Explorer® (see [Turning Off Compatibility Mode](#) below). Extron recommends using Mozilla® Firefox® or Google Chrome™.

This section gives an overview of the internal Web pages, which are always available and cannot be erased or overwritten. Topics in this section include:

- [Accessing the Internal Web Pages](#)
- [Navigating the Internal Web Pages](#)
- [Configuration Pages](#)
- [Hardware Pages](#)

## Accessing the Internal Web Pages

1. Connect the scaler to a LAN or WAN using the rear panel RJ-45 connector.
2. Open a web browser on a connected PC.
3. Enter the IP address of the device in the browser **Address** field.

**NOTE:** The default IP address is 192.168.254.254.

4. Press the <Enter> key on the keyboard.
5. The scaler checks if the device is password-protected.
  - If the device is not password-protected, the web pages open.
  - If the device is password-protected, enter a user name entry (“user” or “admin”) in the **User Name** field and the password in the **Password** field when prompted.
6. Click the **OK** button.

## Turning Off Compatibility Mode

The internal web pages do not support compatibility mode in Microsoft Internet Explorer.

### To check compatibility view settings:

From the **Tools** menu of the browser, select **Compatibility View Settings**. The Compatibility View Settings dialog box opens.

Be sure that the **Display all websites in Compatibility View** check box is clear, and that the IP address of the scaler is not in the list of websites that have been added to Compatibility view.

## Navigating the Internal Web Pages

The internal web pages open with two main tabs: Configuration and Hardware. Below the tabs is a global navigation bar with icons that open various pages for configuration settings and information (see figure 31 and 32 below for available pages on each main tab).



Figure 31. Configuration Global Navigation Bar

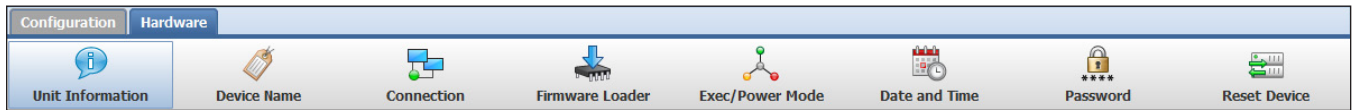

Figure 32. Hardware Global Navigation Bar

Each page is separated into the AV Controls panel and the individual page.

### AV Controls Panel

The AV Controls panel is used to control AV settings such as input selection, performing a one-time Auto-Image to an input, video and audio mute, and image freeze.

At the bottom of the panel is a summary of the current active input and output status, including signal format and HDCP status.

**NOTE:** This panel can be hidden or revealed on any page by clicking on the double arrow button on the top right of the panel.

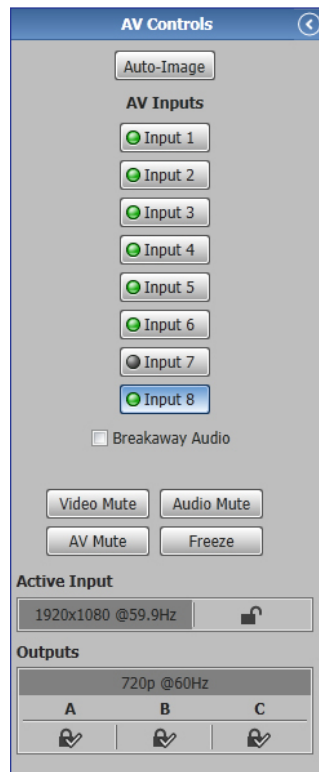

Figure 33. AV Controls Panel

The unlocked icon indicates that an input or output is not HDCP-encrypted. The lock with a check mark icon indicates that an input or output is HDCP-encrypted.

### Auto-Image button

Click the **Auto-Image** button to start a one-time Auto-Image on the currently selected input.

### AV Inputs buttons

Click an AV Inputs button to select an input. As a new input is selected, the summary within the panel changes to reflect the new input and output status.

**NOTE:** The signal indicators on the AV input buttons display green when a signal is present on the corresponding input or gray when there is no signal present.

### Breakaway Audio check box

Select the **Breakaway Audio** check box to enable audio breakaway. The input buttons separate into two columns: video and audio.

From the Video column, click the input button associated with the video to be used.

From the Audio column, click the input button associated with the audio to be used.

#### NOTES:

- Audio breakaway is not available to inputs configured for digital audio formats.
- Video breakaway is not available from inputs configured for digital video formats.

### Video and Audio Mute buttons

Click the **Video Mute** button to mute only the video signal. The button turns red.

Click the **Audio Mute** button to globally mute only the audio. The button turns red.

Click the **AV Mute** button to mute both video and audio simultaneously. The button along with the Video Mute and Audio Mute buttons turn red.

To unmute any signal, click the appropriate button. The button reverts to the default color, indicating the signal has been unmuted.

### Freeze button

Click the **Freeze** button to freeze the current video frame. The button turns blue.



## Configuration Pages

The configuration pages contain options for input and output configuration, EDID management, image settings, image size and position, audio configuration, preset management, and device settings.

### Input and Output Configuration Page

Click the **Input/Output Config** icon on the Global Navigation Bar to open this page. It contains a section for input configuration and output configuration.

#### Input Configuration panel

The Input Configuration panel consists of user configurable fields for each input. These include input naming, signal type, aspect ratio, automatic Auto-Image, Auto Memory, HDCP Authorized status, and Film Detect.

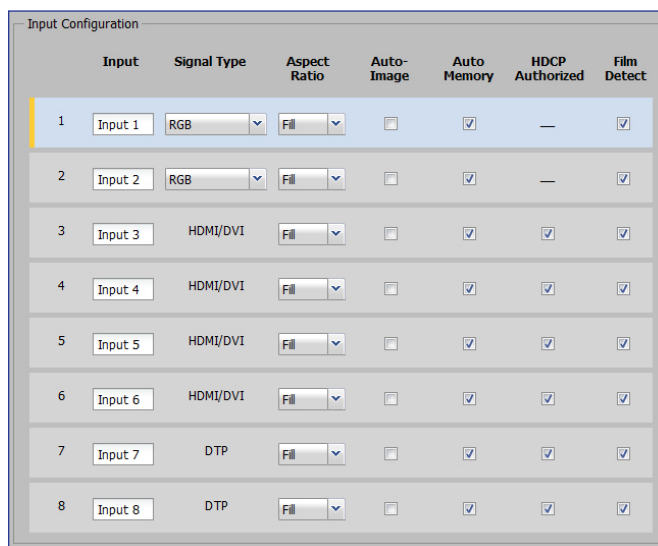

Input	Signal Type	Aspect Ratio	Auto-Image	Auto Memory	HDCP Authorized	Film Detect	
1	Input 1	RGB	Fill	<input type="checkbox"/>	<input checked="" type="checkbox"/>	—	<input checked="" type="checkbox"/>
2	Input 2	RGB	Fill	<input type="checkbox"/>	<input checked="" type="checkbox"/>	—	<input checked="" type="checkbox"/>
3	Input 3	HDMI/DVI	Fill	<input type="checkbox"/>	<input checked="" type="checkbox"/>	<input checked="" type="checkbox"/>	<input checked="" type="checkbox"/>
4	Input 4	HDMI/DVI	Fill	<input type="checkbox"/>	<input checked="" type="checkbox"/>	<input checked="" type="checkbox"/>	<input checked="" type="checkbox"/>
5	Input 5	HDMI/DVI	Fill	<input type="checkbox"/>	<input checked="" type="checkbox"/>	<input checked="" type="checkbox"/>	<input checked="" type="checkbox"/>
6	Input 6	HDMI/DVI	Fill	<input type="checkbox"/>	<input checked="" type="checkbox"/>	<input checked="" type="checkbox"/>	<input checked="" type="checkbox"/>
7	Input 7	DTP	Fill	<input type="checkbox"/>	<input checked="" type="checkbox"/>	<input checked="" type="checkbox"/>	<input checked="" type="checkbox"/>
8	Input 8	DTP	Fill	<input type="checkbox"/>	<input checked="" type="checkbox"/>	<input checked="" type="checkbox"/>	<input checked="" type="checkbox"/>

**Figure 34.** Input Configuration (IN1608)

**NOTE:** DTP inputs 7 and 8 are not available on the IN1606.

#### Input (renaming)

By default, the name associated with an input channel is **Input <number>**. To rename an input, click inside the desired input field and type in the desired name to identify the input. Input names have a 16-character limit.

**NOTE:** Entering a single space character resets the name of the input to the default.

#### Signal type

From the **Signal Type** drop-down menu, select the signal type for inputs 1 and 2 from RGB (default), YUV, RGBcV, S-video, and composite. For all other inputs, HDMI/DVI is the only available signal type.

#### Aspect ratio

From the **Aspect Ratio** drop-down menu, select **Fill** or **Follow**.

- **Fill** — Scales the input signal to fill the entire video output.
- **Follow** — Follows the signal aspect ratio, with respect to the current output resolution setting. Black letter box or pillar box bars may be applied for aspect ratio compensation.

## Auto-Image

Select the **Auto-Image** check box of the desired input to enable an automatic Auto-Image to an input. When enabled, Auto-Image is applied whenever there is a change in the input sync. Auto-Image attempts to size and center the input signal based on the aspect ratio setting.

## Auto Memory

Select the **Auto Memory** check box of the desired input to enable the Auto Memory. Auto Memory recalls input and image settings for signals that have previously been applied. When Auto Memory is disabled, the scaler treats every newly applied input as a new source.

## HDCP Authorized

Select the **HDCP Authorized** check box (inputs 3 and higher) in order to have the input report as an HDCP Authorized device. If the box is not checked, the source is blocked from encrypting its output. This may result in some content not being passed by the source device.

**NOTE:** This option is not available for analog inputs 1 and 2.

## Film Detect

Select the **Film Detect** check box of the desired input to enable automatic 3:2 and 2:2 film pulldown detection for NTSC, PAL, SECAM, and 1080i input signals.

## Output Configuration panel

The Output Configuration panel consists of output resolution, format settings, switch transitions, and available test patterns.

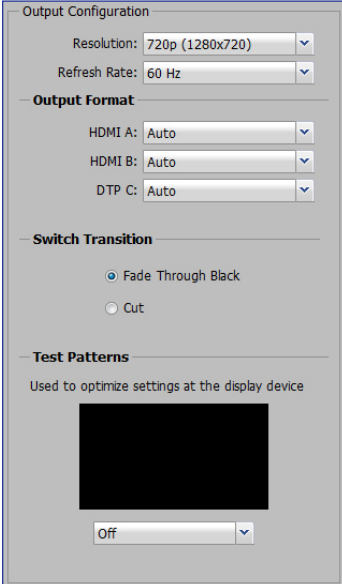

Output Configuration

Resolution: 720p (1280x720)

Refresh Rate: 60 Hz

**Output Format**

HDMI A: Auto

HDMI B: Auto

DTP C: Auto

**Switch Transition**

Fade Through Black

Cut

**Test Patterns**

Used to optimize settings at the display device

Off

**Figure 35. Output Configuration (IN1608)**

**NOTE:** Output **DTP C** is not available on the IN1606.

## Resolution

From the **Resolution** drop-down menu, select the applicable output resolution.

## Refresh rate

From the **Refresh Rate** drop-down menu, select the applicable output refresh rate.

## Output formats

From the **HDMI A**, **HDMI B**, or **DTP C** drop-down menu, select the applicable digital signal format.

**NOTE:** **DTP C** is not available on the IN1606.

## Switch transitions

- **Cut** — Switches video directly to the newly selected input.
- **Fade Through Black** — Fades video to a black screen before switching to the newly selected video.

## Test patterns

To aid display device setup and optimization, select a test pattern from the drop-down menu under the preview window.



Figure 36. Available Test Patterns

**NOTE:** No input signal is needed when using a test pattern for display device setup.

## EDID Minder Page

EDID Minder is an EDID management process that automatically manages the EDID information between the scaler and one or more input sources. Click the **EDID Minder** icon on the Global Navigation Bar to open the EDID Minder page.

Source	Timings	Audio Format	Video Format
<input type="checkbox"/> Input 1	720p @ 60	None	VGA
<input type="checkbox"/> Input 2	720p @ 60	None	VGA
<input type="checkbox"/> Input 3	1080p @ 60	LPCM 2-CH	HDMI
<input type="checkbox"/> Input 4	1080p @ 60	LPCM 2-CH	HDMI
<input type="checkbox"/> Input 5	720p @ 60	LPCM 2-CH	HDMI
<input type="checkbox"/> Input 6	720p @ 60	LPCM 2-CH	HDMI

Figure 37. EDID Minder Page

The EDID properties currently assigned to each input are displayed in the table of inputs. The audio input format listed in an EDID is determined by the Audio Input Format on the Audio Configuration page (unless a custom EDID is used).

### Filtering Available EDID

Use the **Filter** tab to limit the number of available EDID displayed in the Available EDIDs and Connected Outputs section.

1. From the **Resolution** drop-down menu, select a specific resolution or **Any**.
2. From the **Refresh Rate** drop-down menu, select a specific refresh rate or **Any**.

### Assigning EDID

#### To assign EDID to selected inputs:

1. From the inputs group box (table of inputs) on the right, select the check boxes for the desired inputs.
2. From the Available EDIDs or Connected Outputs section on the left, select the desired EDID.
3. From the inputs group box, click the **Assign** button to assign EDID to the selected input or inputs.

#### To assign EDID to all inputs:

1. From the Favorites (PCS only), Connected Outputs, or Available EDIDs section, select an EDID.
2. From the inputs group box, click the **Assign to All** button.

**NOTE:** Checked or unchecked inputs are ignored and the EDID is assigned to all inputs.

#### To match the selected inputs to the current output resolution:

Matching the output resolution is the default value for all inputs.

1. From the inputs group box (table of inputs) on the right, select the check boxes for the desired inputs.
2. In the Output Resolution panel, click the **Match Output** button.

### Adding EDID to the EDID Library

1. Click the **Add EDID to Library** button. The Browse Add EDID to Library window opens.
2. Navigate to the desired EDID file location and select it.

**NOTE:** Valid EDID files have a .bin file extension.

3. Click the **Open** button. The EDID is added to the Available EDIDs section.

### Saving EDID to the EDID Library

1. From the Connected Outputs or Available EDIDs, right-click on an EDID.
2. Select **Save to EDID Library**.
3. Click the **OK** button to save the file.

**NOTE:** Saving a factory scaler EDID exports an HDMI, LPCM-2Ch EDID to the PC. The file is saved as a BIN file.

## Image Settings Page

From this page, signal sampling and picture control settings can be adjusted, user and input presets can be saved and recalled, and overscan settings can be applied. Click the **Image Settings** icon on the Global Navigation Bar to open the Image settings page.

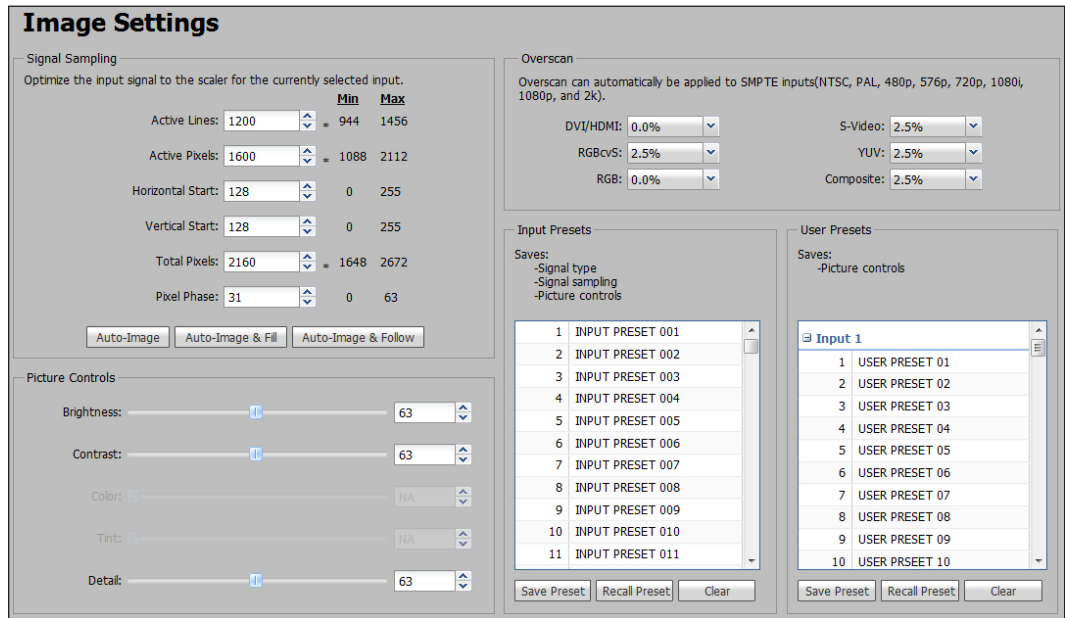

Figure 38. Image Settings Page

### Signal Sampling panel

Signal sampling optimizes the input signal to the scaler for the currently selected input.

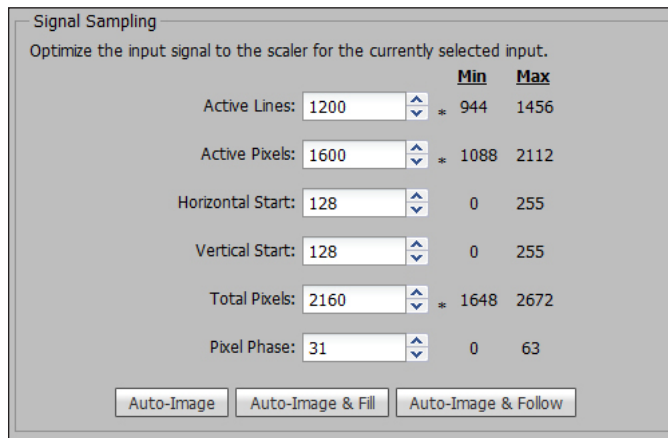

Figure 39. Signal Sampling Panel

To manually adjust signal sampling settings, enter a value within the Min and Max values displayed to the right of each adjustable setting or click the **Up** or **Down** arrows. An asterisk beside a chosen value for a signal sampling setting indicates that it is a default value for the applied video signal.

**To automatically adjust these settings, perform one of the following:**

- Click the **Auto-Image** button to perform a one-time Auto-Image.
- Click the **Auto-Image & Fill** button to perform a one-time Auto-Image and fill the entire video output (ignores aspect ratio setting).
- Click the **Auto-Image & Follow** button to perform a one-time Auto-Image and to maintain the aspect ratio of the input signal (ignores aspect ratio setting).

## Picture Control panel

Picture Control shows adjustable image settings for the selected input.

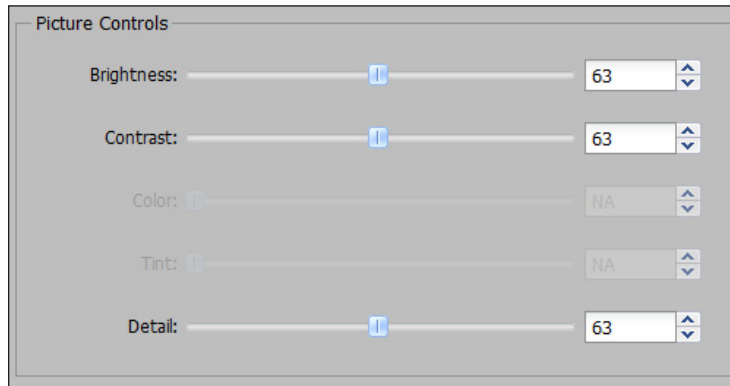

**Figure 40. Picture Control Panel**

To adjust the picture settings, click and drag the associated slider for any image setting (brightness, contrast, color, tint, or detail) to the desired value.

Alternatively, enter a value within the field associated with the image setting, or click the **Up** and **Down** arrows to change the value in the field.

## Overscan panel

Overscan mode zooms and crops SMPTE input resolutions to mask edge effects and ancillary data common in broadcast signals. Issuing an Auto-Image with overscan enabled, runs an Auto Phase routine (YUV and RGB only) and centers and sizes the input.

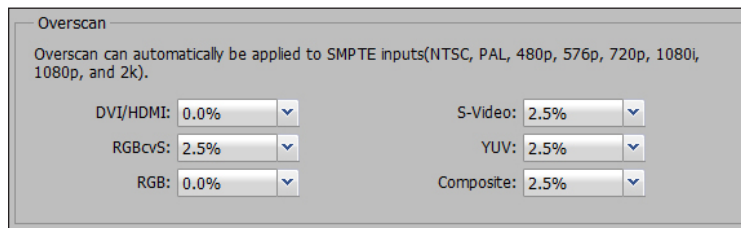

**Figure 41. Overscan Panel**

For each input signal type, select a value from the corresponding drop-down menu.

**NOTE:** Setting a value of 0% disables overscan for the corresponding input format.

## Presets panel

Presets save output settings to be recalled through RS-232 or Ethernet (see the following table for a comparison of saved settings for input and user presets).

Settings Included Within Presets		
Setting	User Preset	Input Preset
Horizontal and Vertical Start		X
Active Lines		X
Pixel Phase		X
Active Pixels		X
Total Pixels		X
Input Type		X
Audio Gain and Attenuation		X
Film Detect		X
Brightness and Contrast	X	X
Color and Tint	X	X
Detail	X	X
Image Size and Position	X	X
Preset Name	X	X

**NOTE:** User presets can be saved on one input resolution and recalled on a different one. Input presets can only be recalled on the same input resolution that was present when the preset was saved.

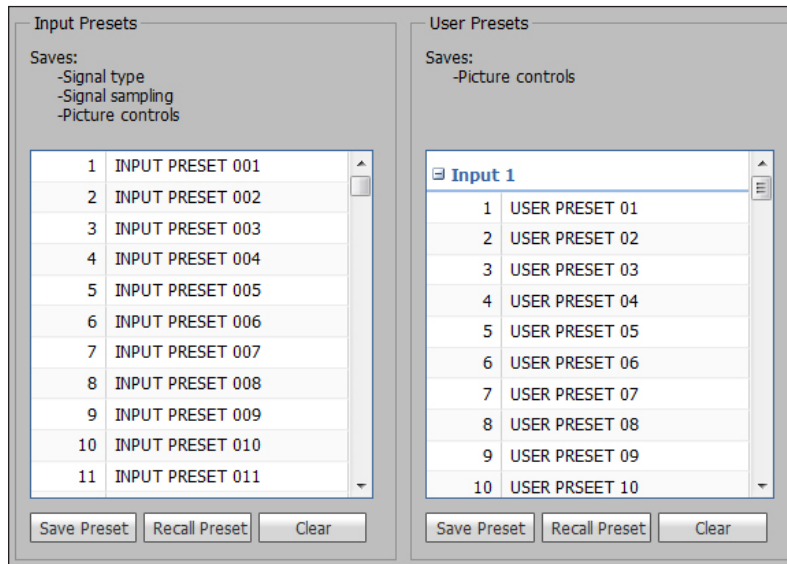

Figure 42. Input and User Presets Panels

## ***Input presets***

There are 128 presets that are global to all inputs. The presets contain all of the settings for an input when used with an upstream matrix switcher. Input presets save signal type, signal sampling, and picture control settings.

### **To save an input preset:**

1. From the Input Presets list, select the desired preset.
2. Click the **Save Preset** button. If the selected preset already has stored information on it, the Presets dialog box opens. Click the **Overwrite** button to erase the previous data and save the new settings. Click the **Cancel** button to return to the Image Settings page.

### **To rename a preset:**

1. From the **Input Preset Name** column, double-click an **Input Preset Name**.
2. Change the name as desired.
3. Press the <Enter> key to save the new name.

### **To recall an input preset:**

1. From the Input Presets list, select the desired preset.
2. Click the **Recall Preset** button. The Presets dialog box opens.
3. Click the **Recall** button to recall the preset. Click the **Cancel** button to return to the Image Settings page.

### **To clear a preset:**

1. From the Input Presets list, select the desired preset.
2. Click the **Clear** button. The Presets dialog box opens.
3. Click the **Clear** button to erase saved data. Click the **Cancel** button to return to the Image Settings page.

## ***User Presets***

There are 16 user presets per input to save picture control settings only.

### **To save a user preset:**

1. From the User Presets list, select the desired preset.
2. Click the **Save Preset** button. If the selected preset already has stored information on it, the Presets dialog box opens. Click the **Overwrite** button to erase the previous data and save the new settings. Click the **Cancel** button to return to the Image Settings page.

### **To rename a preset:**

1. From the **User Preset Name** column, double-click a **User Preset Name**.
2. Change the name as desired.
3. Press the <Enter> key to save the new name.

### **To recall a user preset:**

1. From the User Presets list, select the desired preset.
2. Click the **Recall Preset** button. The Presets dialog box opens.
3. Click the **Recall** button to recall the preset. Click the **Cancel** button to return to the Image Settings page.

### **To clear a preset:**

1. From the User Presets list, select the desired preset.
2. Click the **Clear** button. The Presets dialog box opens.
3. Click the **Clear** button to erase saved data. Click the **Cancel** button to return to the Image Settings page.



## Size and Position Page

The Size and Position page consists of three methods of adjusting image output size and position: graphically, numerically, or automatically with Auto-Image. Click the **Size and Position** icon on the Global Navigation Bar to open the Size and Position page.

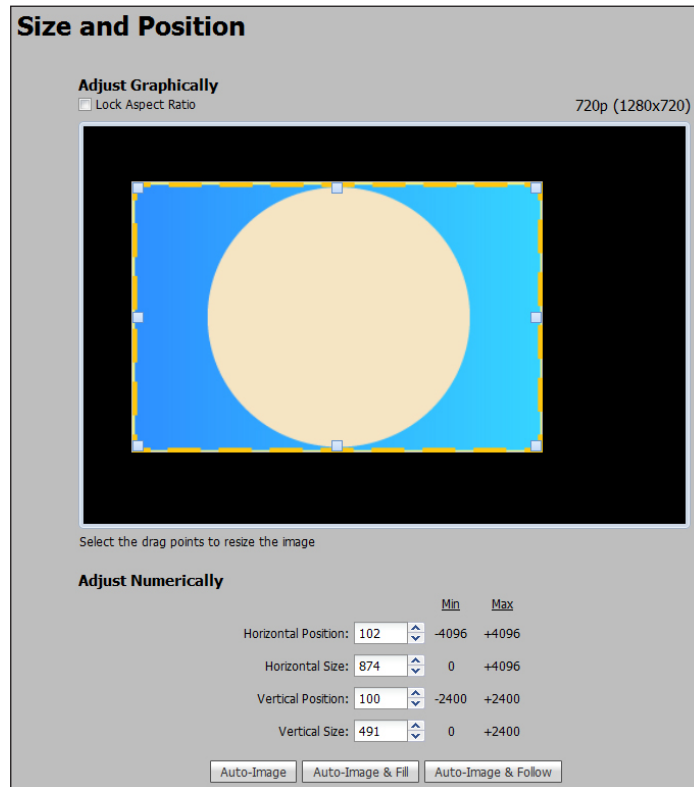

**Figure 43. Size and Position Page**

### To adjust the size and position graphically:

If desired, click the **Lock Aspect Ratio** check box to constrain proportions.

1. Click and drag the drag points of the sample image to resize the image within the designated space (defined by the black area in figure 45 above).
2. Click anywhere inside the sample image (see the blue rectangle with a circle inside in figure 45 above) and drag it anywhere within the designated space to reposition the image.

### To adjust the size and position numerically:

1. Enter a value or click the **Up** or **Down** arrow in the **Horizontal Size** and **Vertical Size** fields.
2. Enter a value or click the **Up** or **Down** arrow in the **Horizontal Position** and **Vertical Position** fields.

### To adjust the size and position automatically:

To automatically adjust these settings, perform one of the following (see [Auto-Image](#) on page 20 for more details on Auto-Image settings):

- Click the **Auto-Image** button to perform a one-time Auto-Image.
- Click the **Auto-Image & Fill** button to perform a one-time Auto-Image and fill the entire video output (ignores aspect ratio settings).
- Click the **Auto-Image & Follow** button to perform a one-time Auto-Image and to maintain the aspect ratio of the input signal. (ignores aspect ratio settings)

## Audio Config Page

From this page, each of the audio inputs can be configured, including setting the input format and analog gain. Click the **Audio Config** icon on the Global Navigation Bar to open the Audio Config page.

### Line Input tab

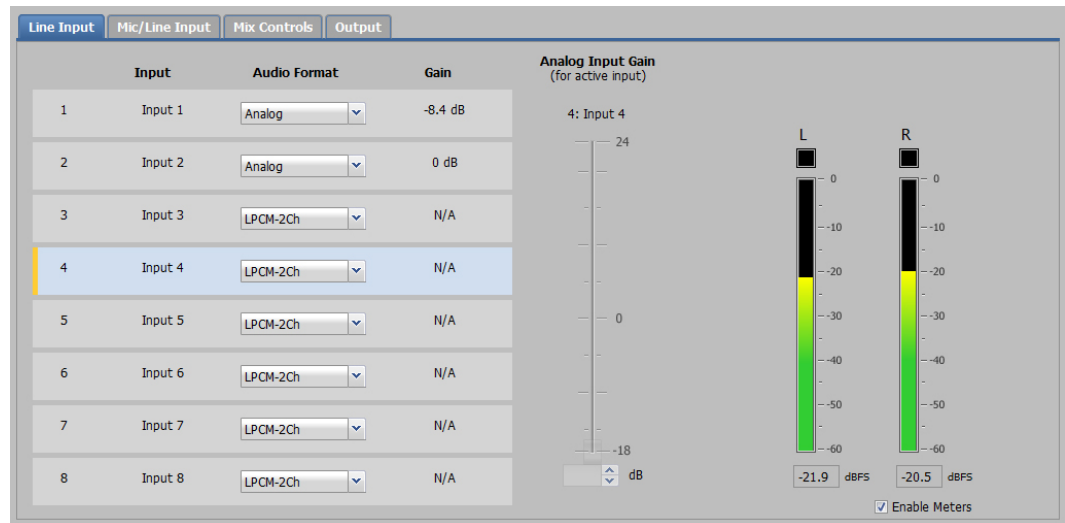
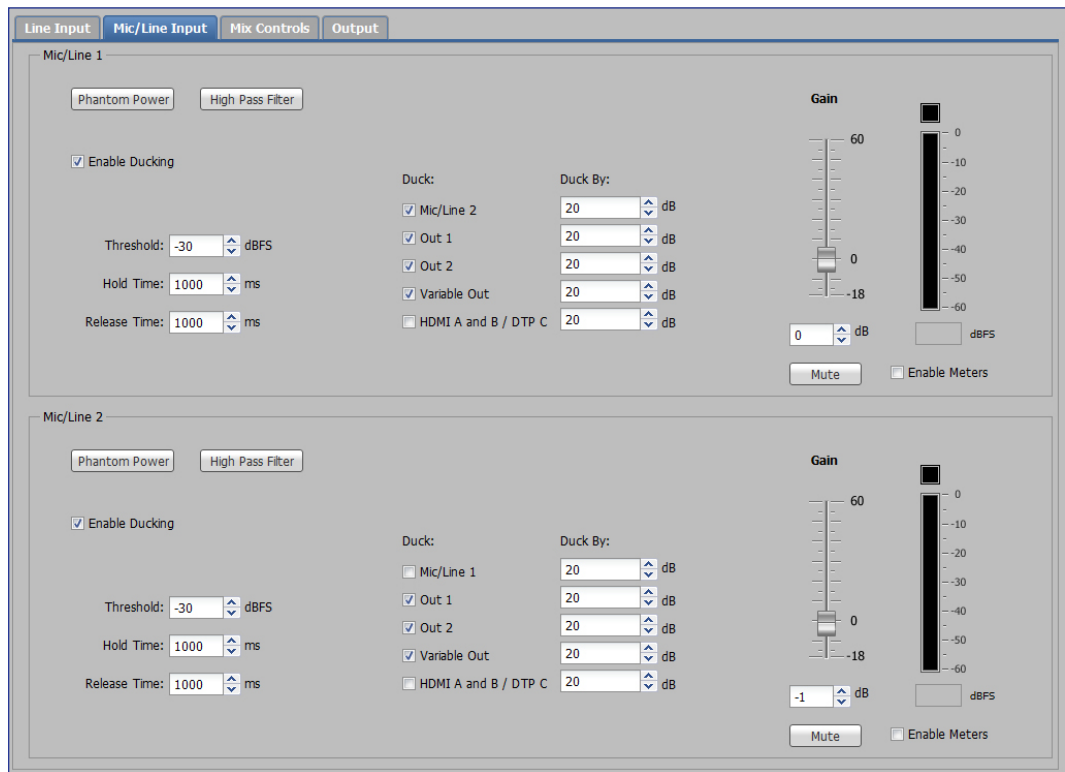

Figure 44. Line Input Tab (IN1608)

**NOTE:** The number of inputs available depends on the scaler model.

1. Click the **Line Input** tab.
2. From the **Audio Format** drop-down menu, select the desired format for the selected input.
3. For inputs configured to **Analog** or one of the **Auto** formats, click and drag the handle of the **Gain** slider, or enter a value in the field or click the **Up** or **Down** arrow to adjust the analog input gain (this can only be applied to analog inputs). The value for each input is displayed in the gain column next to the **Audio Format** drop-down menu.  
The L and R meters display audio levels for analog or LPCM-2Ch inputs.
4. Select the **Enable Meters** check box to display input meters.

## Mic/Line Input tab



**Figure 45. Mic/Line Input Tab with Ducking Enabled (IN1608)**

1. Click the **Mic/Line Input** tab.
2. For each Mic/Line input, click the **Phantom Power** button to enable or disable +48 VDC phantom power on the mic input. The button turns blue when enabled.

### ATTENTION:

- Condenser microphones require +48 V phantom power. Dynamic microphones do not require power. Never enable phantom power with an unbalanced dynamic microphone connected. Doing so may damage the microphone.
- For condenser microphones, verify it will safely operate at +48 VDC.
- When a line level source is connected, be certain the +48 V phantom power is disabled.

3. For each Mic/Line input, click the **High Pass Filter** button to enable or disable a high-pass filter on the mic input. When enabled, lower frequencies are attenuated, allowing higher frequencies to pass. The button turns blue when enabled. The default cutoff is 100 Hz.

4. For each Mic/Line input, select the **Enable Ducking** check box to enable or disable ducking. Enabling ducking opens additional ducking settings as described below. Ducking provides a means to duck or lower the level of the program audio when a specified Mic/Line source must take precedence.
  - a. In the **Threshold** field, enter a value or click the **Up** or **Down** arrow button to set the input signal level the mic/line input must exceed before ducking begins. The default value is -30 dBFS.
  - b. In the **Hold Time** field, enter a value or click the **Up** or **Down** arrow button to set the time between when a mic/line input signal drops below the threshold and before release time engages. The default value is 1000 ms.
  - c. In the **Release Time** field, enter a value or click the **Up** or **Down** arrow button to set the time the ducking targets take to restore program audio signal levels after the mic/line input level is below the threshold and the hold time is met. The default value is 1000 ms.
  - d. Select the applicable **Duck** check boxes to select the desired outputs.
  - e. In the **Duck By** field, enter a value or click the **Up** or **Down** arrow button to specify an individual program audio attenuation setting per ducking target. The default values are 20 dB.
5. For each Mic/Line input, click and drag the handle of the **Gain** slider, enter a value in the field below the slider, or click the **Up** and **Down** arrows to adjust the gain level. The default setting is unity gain (0.0 dB).  
Click the **Mute** button to mute the Mic/Line input.
6. Select the **Enable Meters** check box to display Mic/Line input meters.

### Mix Controls tab

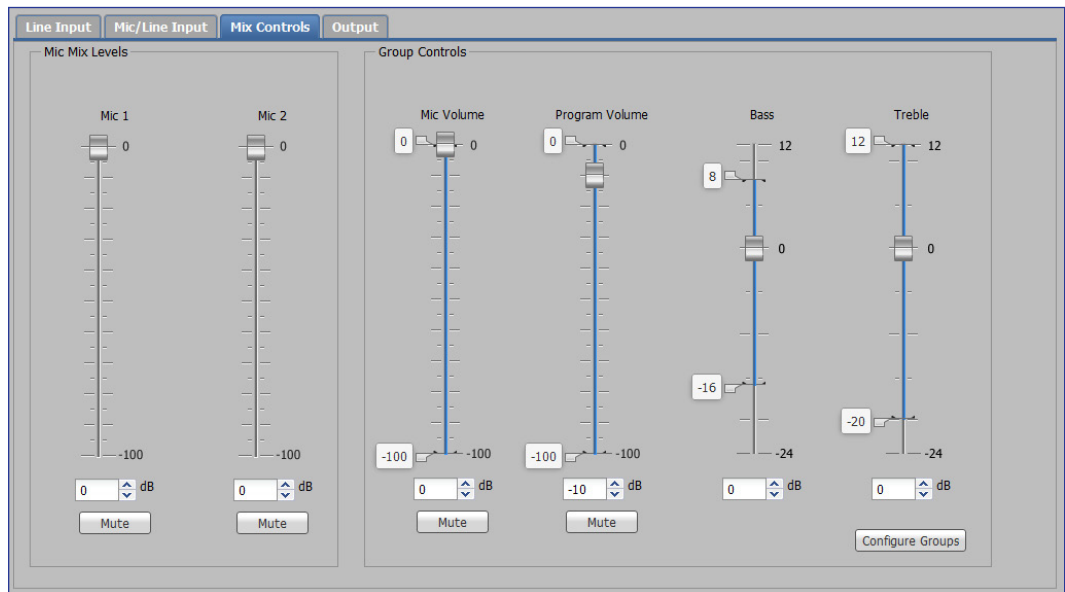

**Figure 46. Mix Controls Tab**

To access the mix control options, click the **Mix Controls** tab.

#### **Mic Mix Levels panel**

For each Mic, click and drag the handle of the **Level1** slider, or enter a value in the field below the slider or click the **Up** or **Down** arrow button.

Click a **Mute** button below the Mic 1 or Mic 2 slider to mute the corresponding Mic input.

## Group Controls panel

1. For the **Mic Volume** and **Program Volume** sliders, click and drag the limiters of the sliders to set minimum and maximum volume limits.
2. Click and drag the handle of the **Mic Volume** and **Program Volume** slider, or enter a value in the field below the sliders or click the **Up** or **Down** arrow button.  
Click the **Mute** button to mute the audio source.
3. For the **Bass** and **Treble** sliders, click and drag the limiters of the sliders to set minimum and maximum limits.
4. Click and drag the handle of the **Bass** and **Treble** slider, or enter a value in the field below the sliders or click the **Up** or **Down** arrow button. The default frequency for bass is 100 Hz. The default frequency is 8 kHz.

Also known as shelving or tone controls, bass and treble filters provide the ability to cut or boost gain linearly above or below a selected frequency. Set either slider to  $\emptyset$  to bypass the filter.

5. Click the **Configure Groups** button in the Group Controls panel. The Configure Groups window opens.

There are eight preconfigured group masters to perform audio configuration.

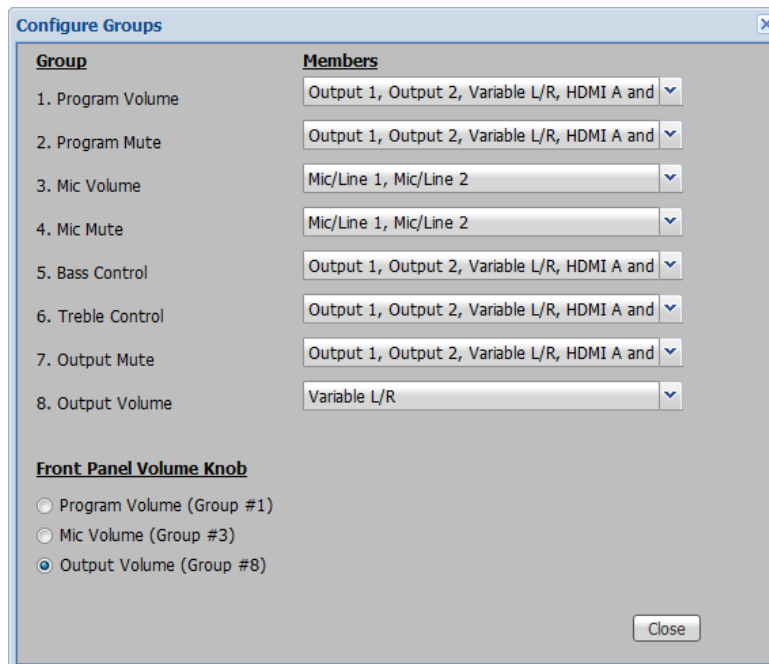

**Figure 47. Configure Groups Window**

Each group contains several group members which can be added or removed from a group. Selecting members applies audio configurations made to the group master to the selected group members (see Group Controls panel above or the **Output tab** on page 73 to adjust group masters).

6. From the **Members** drop-down menu, select the desired members check box (see the table on the next page for a list of available group members per group masters).
7. Click the **Close** button.

Group Master	Group Description	Group Controls Panel Association	Control Type	Applicable Members
1	Program Volume	Program Volume slider	Post-switcher gain	Amplified output Analog output 1 Analog output 2 Variable analog output Digital outputs A, B, and C
2	Program Mute	Program Volume Mute button	Post-switcher mute	Amplified output Analog output 1 Analog output 2 Variable analog output Digital outputs A, B, and C
3	Mic Volume	Mic Volume slider	Pre-mixer gain	Mic/Line 1 Mic/Line 2
4	Mic Mute	Mic Volume Mute button	Pre-mixer mute	Mic/Line 1 Mic/Line 2
5	Bass Control	Bass slider	Bass gain	Amplified output Analog output 1 Analog output 2 Variable analog output Digital outputs A, B, and C
6	Treble Control	Treble slider	Treble gain	Amplified output Analog output 1 Analog output 2 Variable analog output Digital outputs A, B, and C
7	Output Mute	Audio mute button on the AV Controls panel	Output mute	Amplified output Analog output 1 Analog output 2 Variable analog output Digital outputs A, B, and C
8	Output Volume	Front panel volume knob (default)	Output volume	Amplified output Analog output 1 Analog output 2 Variable analog output Digital outputs A, B, and C

**NOTES:**

- Amplified output is for IN1608 SA and IN1608 MA models only.
- DTP C output is for IN1608 models only.

8. Select the desired member from one of the following radio buttons:
  - **Program Volume (Group #1)** — The front panel volume knob adjusts program volume.
  - **Mic Volume (Group #3)** — The front panel volume knob adjusts mic volume.
  - **Output Volume (Group #8)** — The front panel volume knob adjusts output volume (default).
9. Click the **Close** button.

## Output tab

Each output section contains adjustable features for each audio output. Features include output limiters, mix options, and volume control.

An output limiter restricts the input signal level by compressing its dynamic range above a specified threshold. The limiter is most commonly used to prevent clipping, protecting a system against component or speaker damage.

Mix options determines the type of program audio to output and whether to include the mic/line input.

### Amplified Output section (IN1608 SA and MA only)

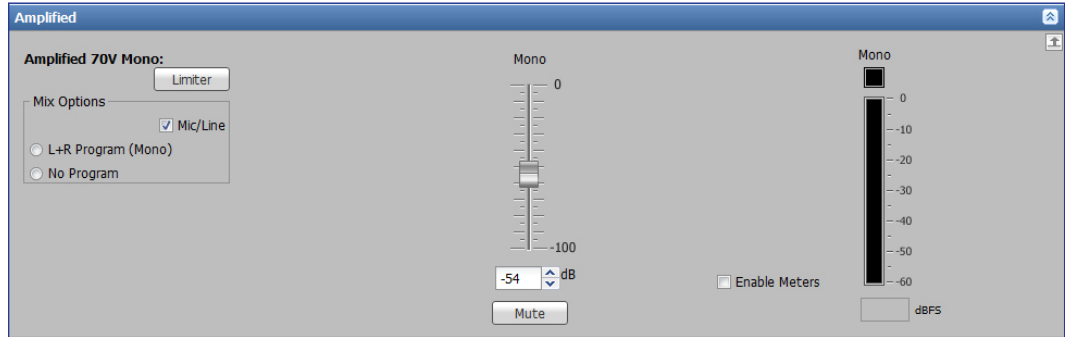
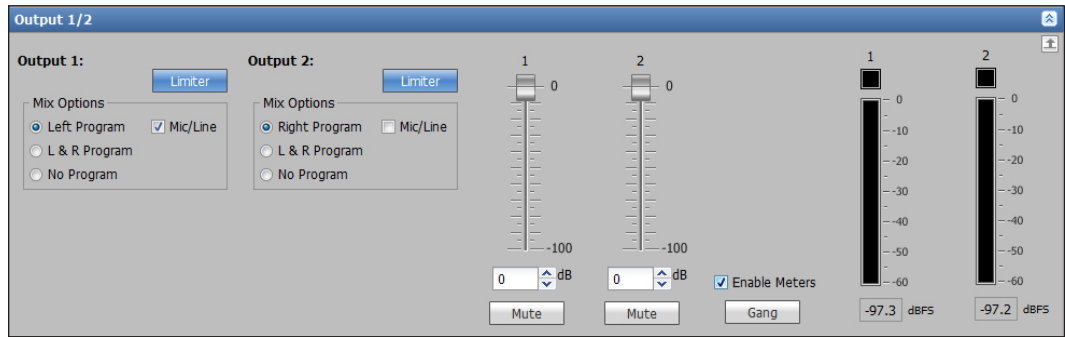

**Figure 48. Amplified Output Section (IN1608 MA)**

1. Click the **Limiter** button to enable or disable a limiter on the output.
2. Select the desired mix option from the Mix Options panel. The options are different for the IN1608 SA and IN1608 MA models.  
For IN1608 SA models, the mix options include the following:
  - **Stereo Program**
  - **Dual Mono Program**
  - **No Program**For IN1608 MA models, the mix options include the following:
  - **L + R Program (Mono)**
  - **No Program**
3. For the desired output, select the **Mic/Line** check box to include the mic/line mix in the output.
4. If desired, click the **Mute** button of the corresponding audio level slider to mute the output. The button turns red when the output is muted. Ignore step 5 if an output is muted. Click the button again to unmute the audio.
5. If an output is not muted, adjust the level in one of the following ways:
  - Click and drag the handle of the audio level slider of the corresponding output.
  - Click the **Up** and **Down** arrows in the field below the corresponding output.
  - Enter a value in the field of the corresponding output.

**NOTE:** On the IN1608 SA, click the **Gang** button to control both output level sliders simultaneously.

## Output 1/2 section



**Figure 49. Output 1/2 Section**

1. Click the **Output** tab.
2. For each output in the Output 1/2 section, click the **Limiter** button to enable or disable a limiter in the output. The button turns blue when it is enabled.
3. For each output, select a mix options radio button from the Mix Options panel.

Output 1 and 2 Mix Options		
Output 1	Output 2	Note
Left Program	Right Program	Output 1 and 2 act as a stereo pair (default).
L and R Program	L and R Program	L and R program audio are summed on each output. They act as unique, independent outputs with or without Mic.
No Program	No Program	No program audio. Output 1 and 2 are treated as unique, independent outputs with or without Mic.

4. For each output, select the **Mic/Line** check box to include the mic/line mix in the output.
5. For each output, click and drag the handle of the output sliders, or enter a value in the field below the sliders or click the **Up** or **Down** arrow button to adjust the output level.  
Click the **Mute** button for either slider to mute the output.  
Click the **Gang** button to control both sliders simultaneously.
6. Select the **Enable Meters** check box to display output meters.



## Variable section

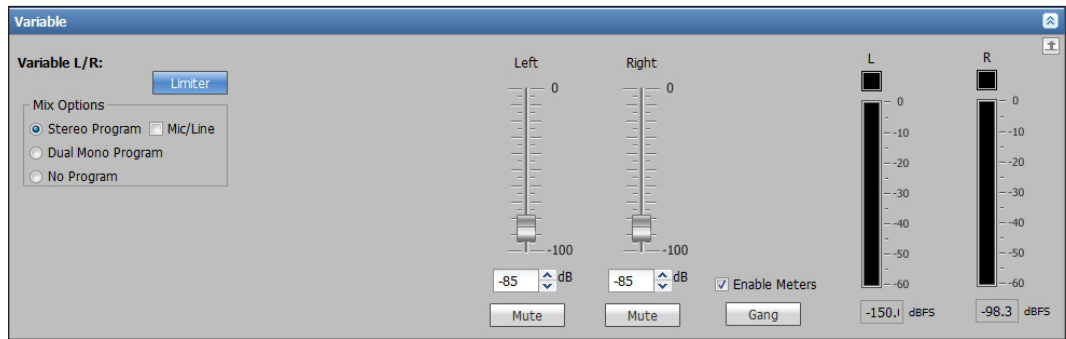

**Figure 50. Variable Section**

1. Click the **Output** tab.
2. In the Variable section, click the **Limiter** button to enable or disable a limiter in the output. The button turns blue when enabled.
3. From the Mix Options panel, select a Mix Options radio button.
4. From the Mix Options panel, select the **Mic/Line** check box to include the mic/line mix in the output.
5. For the **Left** or **Right** sliders, click and drag the handle of the sliders, enter a value in the field below the sliders, or click the **Up** or **Down** arrow button to adjust the output level. Click the **Mute** button for either slider to mute the output. Click the **Gang** button to control both sliders simultaneously.
6. Select the **Enable Meters** check box to display output meters.

## HDMI section

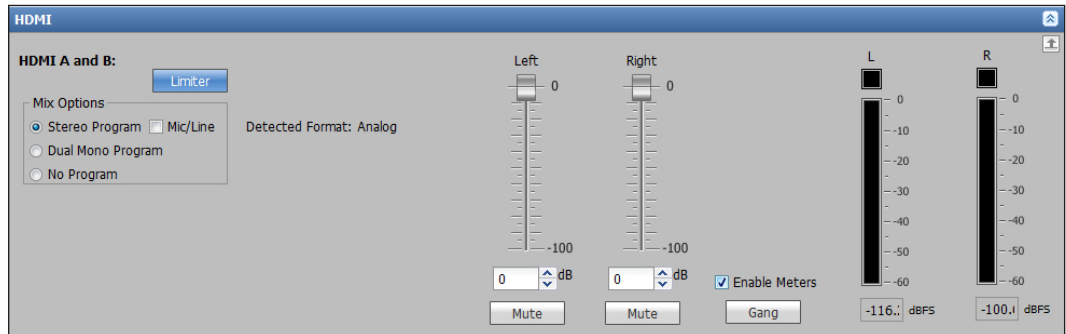
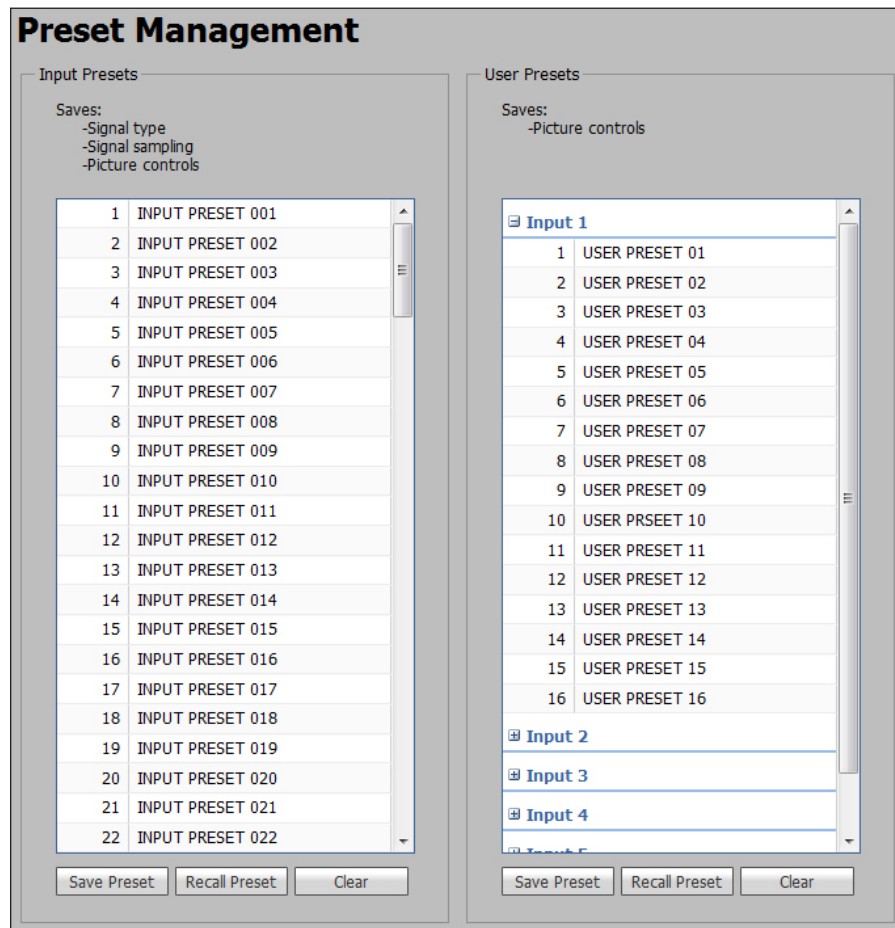

**Figure 51. HDMI Section**

1. Click the **Output** tab.
  2. In the HDMI section, click the **Limiter** button to enable or disable a limiter in the output. The button turns blue when enabled.
  3. From the Mix Options panel, select a **Mix Options** radio button.
  4. From the Mix Options panel, select the **Mic/Line** check box to include the mic/line mix in the output.
- NOTE:** The detected program audio format can be None, Analog, LPCM-2Ch, or Multi-Ch.
5. For the **Left** or **Right** sliders, click and drag the handle of the sliders, enter a value in the field below the sliders, or click the **Up** or **Down** arrow button to adjust the output level. Click the **Mute** button for either slider to mute the output. Click the **Gang** button to control both sliders simultaneously.
  6. Select the **Enable Meters** check box to display output meters.

## Preset Management Page

The Preset Management page gives access to input and user presets. Click the **Preset Management** button on the Global Navigation Bar to open the Preset Management page.



**Figure 52. Preset Management Page**

### To save a preset:

1. Select the input preset or user preset to store the current configuration.
2. Click the **Save Preset** button located in the same Input Presets or User Presents panel. If the selected preset already has stored information on it, the Presets dialog box opens. Click the **Overwrite** button to erase the previous data and save the new settings. Click the **Cancel** button to return to the Preset Management page.

### To recall a preset:

1. Select the input preset or user preset to be recalled.
2. Click the **Recall Preset** button located in the same Input Presets or User Presents panel. The Presets dialog box opens.
3. Click the **Recall** button to recall the preset. Click the **Cancel** button to return to the Preset Management page.

### To clear a preset:

1. Select the input preset or user preset to be cleared.
2. Click the **Clear** button located in the same section of the screen. A confirmation dialog box opens. The Presets dialog box opens.
3. Click the **Clear** button to erase saved data. Click the **Cancel** button to return to the Preset Management page.

### To rename a preset:

1. Double-click a Preset Name or right-click the Preset Name and select **Rename**.
2. Enter a new preset name and press the <Enter> key.

## Device Settings Page

The Device Settings page allows configuration of Screen Saver settings, on-screen display timeout, HDCP notification, and video and sync muting. Click the **Device Settings** button on the Global Navigation Bar to open the Device Settings page.

The screenshot shows the 'Device Settings' page with the following sections:

- Screen Saver:** Displays when no input signal is detected. Options include **Black** (selected), **Blue with On Screen Display (OSD) Bug**, and a checkbox for **Disable Sync After** (set to N/A) with a duration field for seconds (1-500).
- HDCP Notification:** Select display color when sending HDCP content on a non-compliant display. Options include **Black** and **Green** (selected).
- OSD Input Information:** OSD input information displays after every input switch. Includes a checked checkbox for **Enable On Screen Display (OSD)** and a **Duration On Screen** field set to 3 seconds (1-500).
- Auto Switch:** Includes a checked checkbox for **Enable Auto Switch** and two radio button options: **Priority to the highest active input number** (selected) and **Priority to the lowest active input number**.
- Mute Video and Sync:** This may allow a connected sink to go into a power saving mode. Includes a **Mute Video and Sync** button.

Figure 53. Device Settings Page

### Screen Saver panel

When no active video is detected on the selected input, the screen saver mode is activated. The output sync can be disabled after a user-set duration, which allows display devices to go into a low power, standby state.

1. Click one of the radio buttons to select a color to display when the screen saver is enabled.
  - **Black** — Mutes video output to black for a set duration before disabling output sync (default).
  - **Blue with On Screen Display** — Displays a blue background with a moving OSD bug that indicates “<scaler model>: Input <#> No Signal” for a set duration before disabling the output sync.
2. Select a Disable Sync duration.
  - Select the **Disable Sync When No Input Signal Is Detected** check box to disable the scaler output sync after a set duration without an active input. When selected, the **Duration On Screen** field becomes available.
  - In the **Duration On Screen** field, enter a value in the field or click the **Up** and **Down** arrows to specify a duration to wait before disabling output sync during inactivity. The default is to never disable the output sync.

## OSD Input Information panel

1. To display input information on the OSD bug after input selection, select the **Enable On Screen Display (OSD)** check box.
2. In the **Duration On Screen** field, enter a value or click the **Up** or **Down** arrow button to set a duration the information is displayed on the OSD menu. The default value is 3.

## Auto Switch panel

Auto switch mode automatically switches inputs based on detected input signals.

1. Select the Enable Auto Switch check box to enable auto switch mode.
2. Click the radio button of the desired type of auto switch mode from the following:
  - **Priority to the highest active input number** — Automatically switches the input to the highest numbered active input.
  - **Priority to the lowest active input number** — Automatically switches the input to the lowest numbered active input.

## HDCP Notification panel

HDCP notification indicates when HDCP content restrictions prevent a video signal from passing.

- **Black** — Displays a black or muted screen when an encrypted source is sent to a display that is not HDCP-compliant.
- **Green** — Displays a green screen when an encrypted source is displayed on a sink that is not HDCP-compliant (default).

## Mute Video and Sync panel

Click the **Mute Video and Sync** button to mute the active video and disable sync on the HDMI outputs.

## Hardware Pages

The Hardware pages contain unit information and options for device naming, communication, settings, executive and power modes, date and time settings, passwords, and reset modes. Click the **Hardware** tab to open these pages.

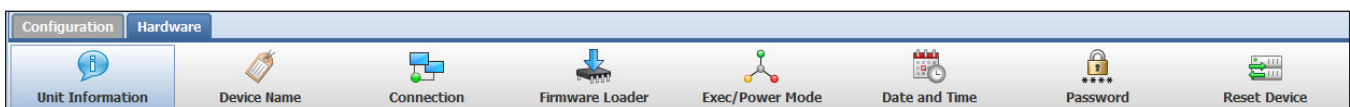

Figure 54. Hardware Global Navigation Bar

## Unit Information Page

This page gives a non-configurable view of information about the connected device. Click the **Unit Information** button to open the page.

The following information is displayed:

- Part number
- Model name
- Model description
- Firmware version
- Temperature
- Default web version
- Device name
- DHCP status
- IP address
- Subnet mask
- Default gateway
- MAC address
- DNS server

Click the **License Information** button to view details about third-party packages and associated licensing.

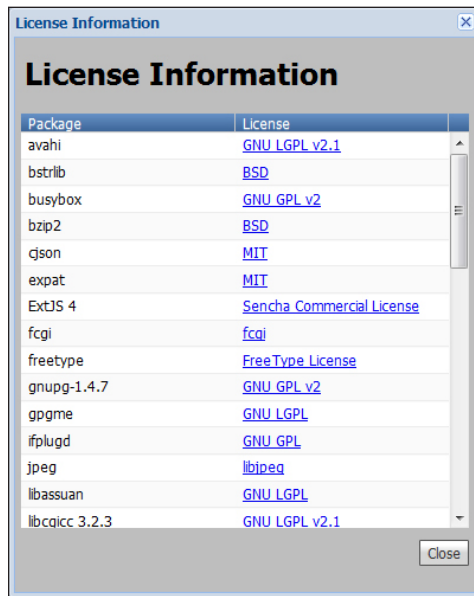
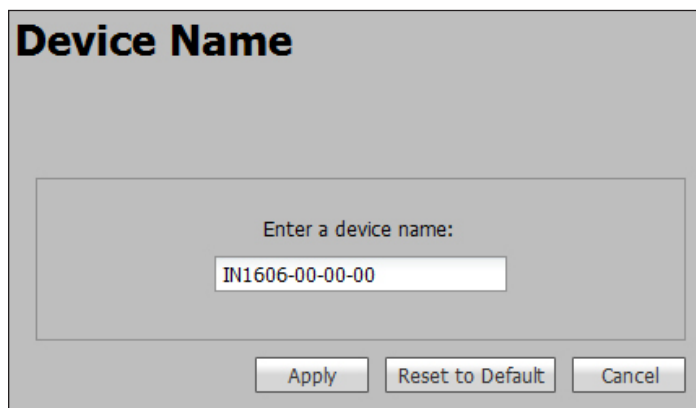

**Figure 55. License Information Window**

To view a copy of a listed package license, click the link in the License column for the relevant package (see [Licensed Third-Party Software Used in the Scalars](#) on page 4).

## Device Name Page

This page allows users to assign or change the name or hostname of the connected device. Click the **Device Name** icon on the Global Navigation Bar to open this page.



**Figure 56. Device Name Page**

**NOTE:** The device name is used as the hostname of the scaler.

### To assign or change the hostname:

1. Enter a name for the device in the name field. This can be up to 63 alphanumeric characters in length with no spaces between characters. If an invalid name is entered, a red symbol appears to the right of the name field.
2. Click the **Apply** button to change the name. Click the **Cancel** button to keep the previous name.

### To reset the name:

Click the **Reset to Default** button.

## Communication Settings Page

The Communication Settings page contains options to adjust device settings for RS-232 and Ethernet connections. Click the **Communication Settings** icon on the Global Navigation Bar to open the page.

The screenshot displays the 'Communication Settings' interface. It is divided into two main sections: 'RS-232' and 'TCP/IP'.  
The 'RS-232' section includes:  
- Baud Rate: 9600 (dropdown menu)  
- Parity Bit: None  
- Data Bit: 8  
- Stop Bit: 1  
The 'TCP/IP' section includes:  
- Hostname: IN1608-00-00-00 (with an information icon)  
- Use DHCP:  (unchecked)  
- (Obtain IP address automatically)  
- IP Address: 192.168.254.254  
- Subnet Mask: 255.255.0.0  
- Default Gateway: 0.0.0.0  
- DNS Server: 127.0.0.1  
- MAC Address: 00-00-00-00-00-0C  
At the bottom of the page are three buttons: 'Apply', 'Reset to Default', and 'Cancel'.

Figure 57. Communication Settings Page

### RS-232 settings

1. From the **Baud Rate** drop-down menu, select the appropriate baud rate.
2. Click the **Apply** button.

### Ethernet settings

#### To configure the Ethernet settings for use with DHCP:

1. Select the **Use DHCP** check box.
2. Click the **Apply** button.

#### To configure the Ethernet settings with a static IP address:

1. Ensure the **Use DHCP** check box is not selected.
2. In the **IP Address** field, enter an IP address.
3. In the **Subnet Mask** field, enter the subnet mask if required.
4. In the **Default Gateway** field, enter the default gateway if required.
5. In the **DNS Sever** field, enter a DNS server name if required.
6. Click the **Apply** button.

#### To reset to default settings:

To reset the device to default connection values, click the **Reset to Default** button.

#### To cancel changes:

At any time, click the **Cancel** button to keep the last saved settings.

## Firmware Loader Page

The Firmware Loader page provides a means of uploading firmware files to the connected scaler. Click the **Firmware Loader** icon on the Global Navigation Bar to open this page.

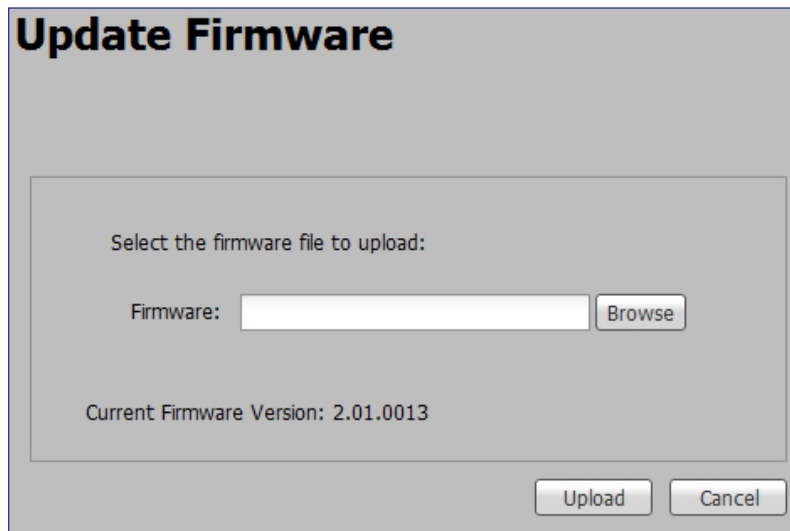

**Update Firmware**

Select the firmware file to upload:

Firmware:

Current Firmware Version: 2.01.0013

**Figure 58. Firmware Loader**

1. If necessary, download firmware updates from the Extron website, [www.extron.com](http://www.extron.com).
2. Click the **Browse** button. The Choose File to Upload window opens.
3. Navigate to the firmware file location and select the firmware file. Valid firmware files have an .eff extension.
4. Click the **Open** button. The window closes
5. Click the **Upload** button.

**NOTE:** The connection to the scaler may have to be re-established.

## Executive/Power Mode Page

The Executive/Power Mode page contains options for enabling or disabling executive and power modes. Click the **Exec/Power Mode** icon on the Global Navigation Bar to open the page.

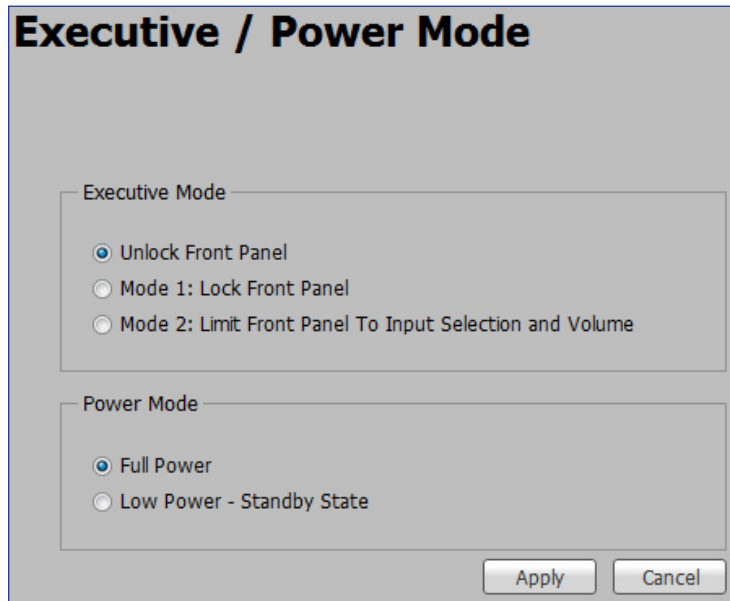

**Executive / Power Mode**

Executive Mode

- Unlock Front Panel
- Mode 1: Lock Front Panel
- Mode 2: Limit Front Panel To Input Selection and Volume

Power Mode

- Full Power
- Low Power - Standby State

Apply Cancel

**Figure 59. Executive/Power Mode Page**

### Executive mode

Executive mode locks the front panel functions of the scaler.

1. Select one of the following radio buttons to set the Executive mode (see [Front Panel Lockout \(Executive Modes\)](#) on page 27).
  - **Unlock the Front Panel** (default)
  - **Mode 1: Lock Front Panel** (complete lockout)
  - **Mode 2: Limit Front Panel To Input Selection and Volume**
2. Click the **Apply** button.

### Power mode

The low power-standby state disables all video input processing and all video outputs to save energy when the scaler is not in use.

1. Click the **Full Power** radio button or the **Low Power - Standby State** radio button to select the desired power mode.
2. Click the **Apply** button.



## Date and Time Page

The Date and Time page contains adjustable device date and time settings. Click the **Date and Time** icon from the Global Navigation Bar to open the page.

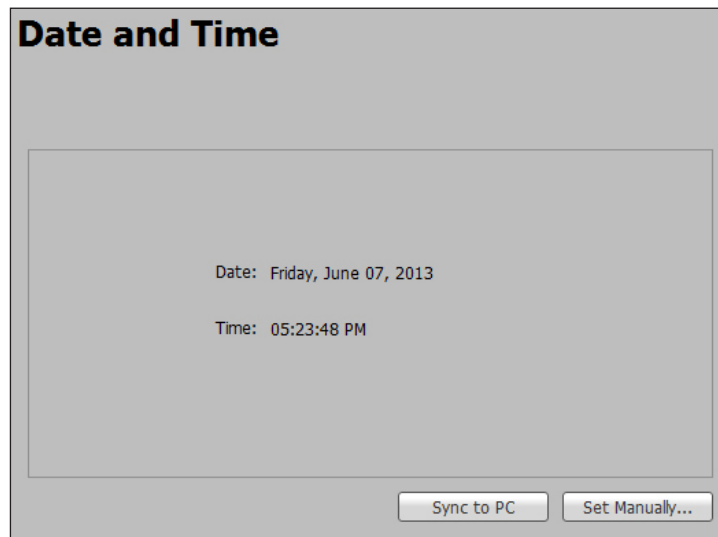

**Figure 60. Date and Time Page**

### To automatically sync the date and time to a connected PC:

Click the **Sync to PC** button.

### To manually set the date and time:

1. Click the **Set Manually...** button. The Date and Time Settings window opens.
2. Click the **Calendar** icon to open a calendar dialog box of selectable dates.
  - a. Click the **Date Picker** button to the right of the month and year to open a table of selectable months and years.

**NOTE:** Use the Left arrow or Right arrow button to view more years.

- b. Select the desired month and year.
  - c. Click the **OK** button to accept the new settings or click the **Cancel** button to exit the dialog box.

**NOTE:** Alternatively, click the **Previous Month** or **Next Month** button on the far left and right of the month and year to cycle through dates.

- d. Select the desired day.

**NOTE:** Click the **Today** button to select the current day on the host device.

3. Click outside the Calendar dialog box to save the selection.
4. For the **Time** fields, enter a valid value in the various time fields or click the **Up** or **Down** arrow button to specify hours, minutes, and seconds.
5. From the drop-down menu to the right of the **Seconds** field, select AM or PM.
6. Click the **Apply** button.

## Password Page

This page allows the user to set an administrator and user password on the device. Click the **Password** icon from the Global Navigation Bar to open the page.

The screenshot shows a web interface for setting passwords. It is titled "Password" and is divided into two main sections. The first section is for the administrator, with "Login ID: admin" displayed. It contains two text input fields: "Administrator Password:" and "Confirm Password:". Below these fields is a checkbox labeled "Show Password" and a "Clear" button. The second section is for the user, with "Login ID: user" displayed. It also contains two text input fields: "User Password:" and "Confirm Password:". Below these fields is a checkbox labeled "Show Password" and a "Clear" button. At the bottom of the page, there are two buttons: "Apply" and "Cancel".

**Figure 61. Password Page**

Administrators and users can view all settings on the device. Administrators have the ability to make adjustments to any setting. Users can only make changes to input selection, volume, freeze, user preset recall, input preset recall, audio mute, video mute, Auto-Image, Auto-Image and Fill, and Auto-Image and Follow.

**NOTE:** If a password is set, a username is required to access the internal web pages or the device through the PCS program. When prompted, enter **admin** as the username for administrator passwords or **user** as the username for user passwords.

### To create or change an administrator password:

1. In the **Administrator Password** field, enter the desired administrator password.
2. In the **Confirm Password** field, re-enter the administrator password.

**NOTE:** Select the **Show Password** check box to display the password characters.

3. Click the **Apply** button.

### To create a user password:

**NOTE:** A user password cannot be set until an administrator password has been entered.

1. In the **User Password** field, enter the desired user password.
2. In the **Confirm Password** field, re-enter the user password.

**NOTE:** Select the **Show Password** check box to display the password characters.

3. Click the **Apply** button.

**NOTE:** When passwords are set, a notification to close and restart the browser appears.

## Reset Device Page

This page allows the user to reset the device. Click on the **Reset Device** icon from the Global Navigation Bar to open the page.

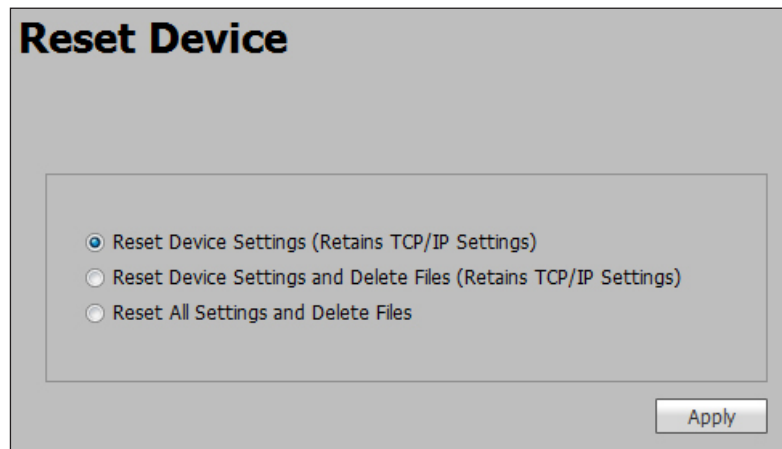

The screenshot shows a web interface titled "Reset Device". It contains a form with three radio button options:

- Reset Device Settings (Retains TCP/IP Settings)
- Reset Device Settings and Delete Files (Retains TCP/IP Settings)
- Reset All Settings and Delete Files

An "Apply" button is located at the bottom right of the form.

**Figure 62. Reset Device Page**

There are three reset options:

- **Reset Device Settings (Retains TCP/IP Settings)** — Resets the settings associated with input settings, the output image, EDID, and audio, and also includes presets and auto memories (excludes communication settings).

This is equivalent to the **[Esc] ZXXX ←** SIS command.

**NOTE:** Communication settings include the IP address, subnet mask, gateway IP address, device name, DHCP setting, and port mapping.

- **Reset Device Settings and Delete Files (Retains TCP/IP Settings)** — Resets all settings on the device to factory defaults (deletes user files), except the Ethernet settings.

This is equivalent to the **[Esc] ZY ←** SIS command.

- **Reset All Settings and Delete Files** — Resets all settings on the device to factory defaults (deletes user files) including the communication settings.

This is equivalent to the **[Esc] ZQQQ ←** SIS command.

**NOTES:**

- The default IP address is 192.168.254.254.
- The default DHCP setting is Off.

**To reset the device:**

1. Click the radio button of the desired reset option.
2. Click the **Apply** button. A confirmation dialog box opens.
3. In the dialog box, click the **Reset** button to continue with the reset, or the **Cancel** button to abort the reset.

# Reference Information

This section provides reference or supplemental information. Topics in this section include:

- [Mounting](#)
- [Downloading Updated Firmware](#)

## Mounting

### Tabletop Mounting

Attach the provided rubber feet to the bottom four corners of the enclosure.

### Rack Mounting

The scalers can be mounted into racks with the pre-installed rack ears (see [UL Guidelines for rack mounted devices](#) on page 87). To install the device, line up the screw holes on the rack ears on both side of the device with the screw holes in the rack so they device is level. Use the provided screws to attach the device to the rack.

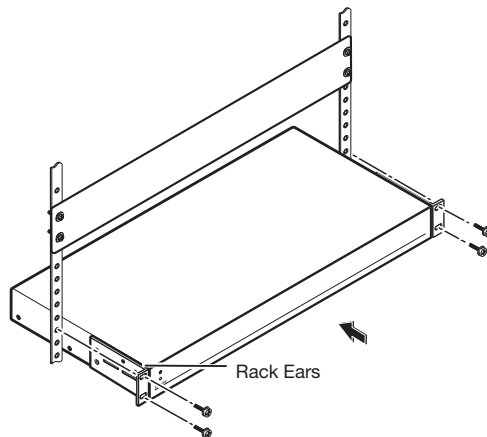

**Figure 63. 1U Rack Mounting**

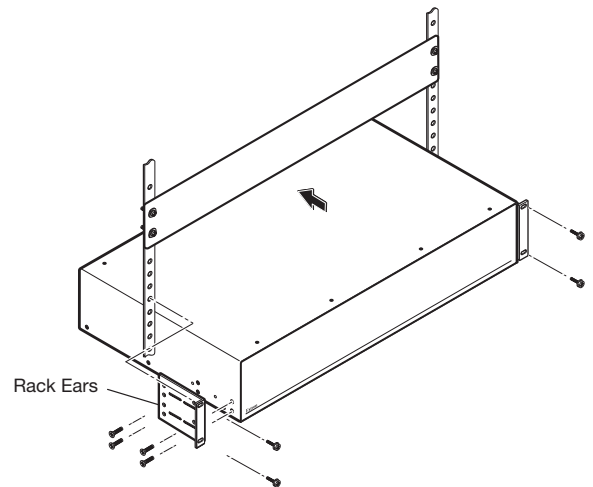

**Figure 64. 2U Rack Mounting**

## UL Guidelines for rack mounted devices

The following Underwriters Laboratories (UL) guidelines pertain to the safe installation of the scaler in a rack.

- 1. Elevated operating ambient temperature** — If installed in a closed or multi-unit rack assembly, the operating ambient temperature of the rack environment may be greater than room ambient temperature. Therefore, install the scaler in an environment compatible with the maximum ambient temperature ( $T_{ma} = +122\text{ }^{\circ}\text{F}$ ,  $+50\text{ }^{\circ}\text{C}$ ) specified by Extron.
- 2. Reduced air flow** — Install the equipment in a rack so that the amount of air flow required for safe operation of the equipment is not compromised.
- 3. Mechanical loading** — Mount the equipment in the rack so that a hazardous condition is not achieved due to uneven mechanical loading.
- 4. Circuit overloading** — Connect the equipment to the supply circuit and consider the effect that circuit overloading might have on overcurrent protection and supply wiring. Appropriate consideration of equipment nameplate ratings should be used when addressing this concern.
- 5. Reliable earthing (grounding)** — Maintain reliable grounding of rack-mounted equipment. Pay particular attention to supply connections other than direct connections to the branch circuit (e.g. use of power strips).

## Furniture Mounting

See the Extron website, [www.extron.com](http://www.extron.com), for a list of available furniture mounting kits. To install the scaler to furniture, follow the mounting kit instructions.

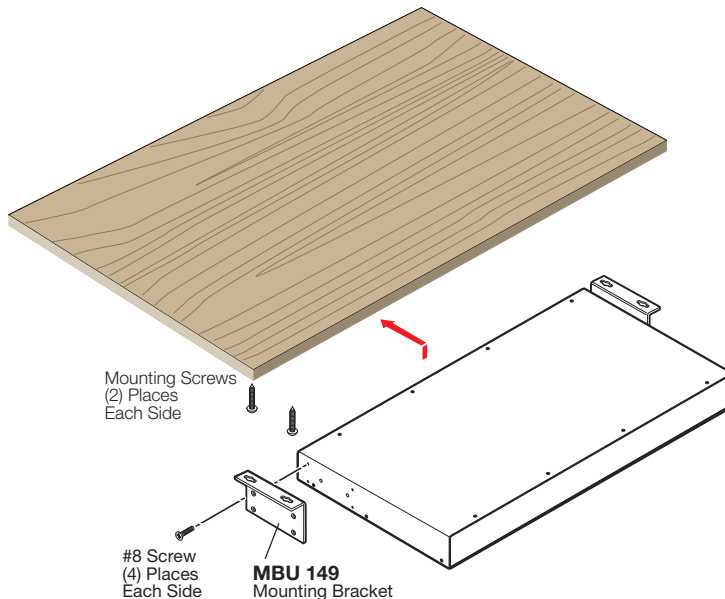
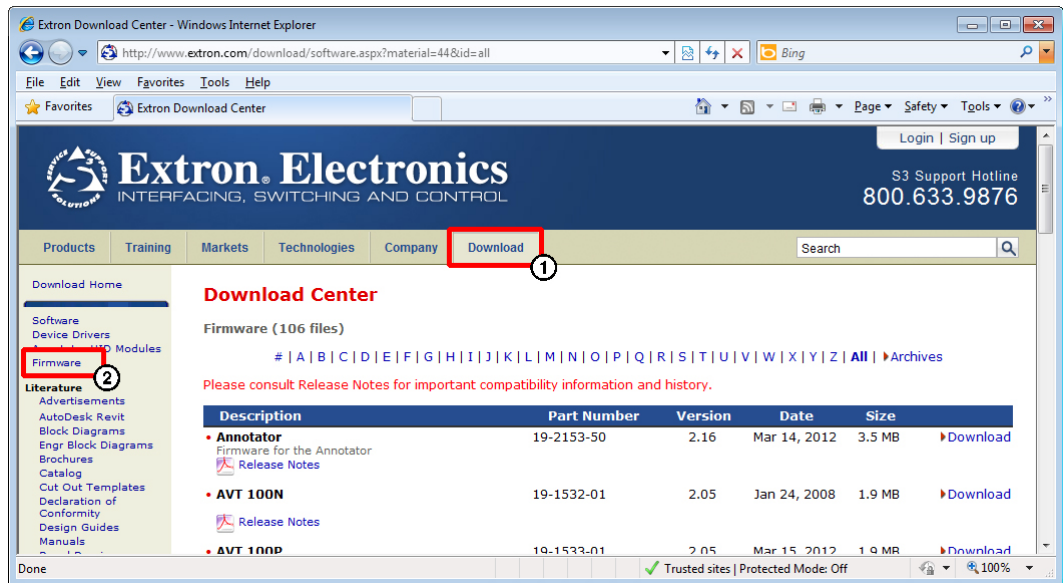

Figure 65. Under-Desk Mounting

## Downloading Updated Firmware



**Figure 66. Downloading Firmware from the Extron website**

1. On the Extron website, [www.extron.com](http://www.extron.com), click the **Download** tab.
2. From the left sidebar, click the **Firmware** link.
3. Navigate to the IN1606 or IN1608 model.
4. Ensure the available firmware version is a later version than the current one on the device.

**NOTE:** The firmware release notes provide details about the changes between different firmware versions. The file can be downloaded from the same page as the firmware.

5. Click the **Download** link to the right of the desired device.
6. Submit required information to start the download. Note where the file is saved.
7. From the save location, open the executable (.exe) file.
8. Follow the instructions on the Installation Wizard screens to install the new firmware on the computer. A Release Notes file, giving information on what has changed in the new firmware version, and a set of instructions for updating the firmware are also loaded.
9. Use Extron Firmware Loader, the internal web pages (see [Firmware Loader Page](#) on page 81), or the Product Configuration Software to upload firmware from the PC to the scaler.

## Extron Warranty

Extron Electronics warrants this product against defects in materials and workmanship for a period of three years from the date of purchase. In the event of malfunction during the warranty period attributable directly to faulty workmanship and/or materials, Extron Electronics will, at its option, repair or replace said products or components, to whatever extent it shall deem necessary to restore said product to proper operating condition, provided that it is returned within the warranty period, with proof of purchase and description of malfunction to:

**USA, Canada, South America, and Central America:**

Extron Electronics  
1230 South Lewis Street  
Anaheim, CA 92805  
U.S.A.

**Japan:**

Extron Electronics, Japan  
Kyodo Building, 16 Ichibancho  
Chiyoda-ku, Tokyo 102-0082  
Japan

**Europe and Africa:**

Extron Europe  
Hanzeboulevard 10  
3825 PH Amersfoort  
The Netherlands

**China:**

Extron China  
686 Ronghua Road  
Songjiang District  
Shanghai 201611  
China

**Asia:**

Extron Asia  
135 Joo Seng Road, #04-01  
PM Industrial Bldg.  
Singapore 368363  
Singapore

**Middle East:**

Extron Middle East  
Dubai Airport Free Zone  
F12, PO Box 293666  
United Arab Emirates, Dubai

This Limited Warranty does not apply if the fault has been caused by misuse, improper handling care, electrical or mechanical abuse, abnormal operating conditions, or if modifications were made to the product that were not authorized by Extron.

**NOTE:** If a product is defective, please call Extron and ask for an Application Engineer to receive an RA (Return Authorization) number. This will begin the repair process.

**USA:** 714.491.1500 or 800.633.9876

**Europe:** 31.33.453.4040

**Asia:** 65.6383.4400

**Japan:** 81.3.3511.7655

Units must be returned insured, with shipping charges prepaid. If not insured, you assume the risk of loss or damage during shipment. Returned units must include the serial number and a description of the problem, as well as the name of the person to contact in case there are any questions.

Extron Electronics makes no further warranties either expressed or implied with respect to the product and its quality, performance, merchantability, or fitness for any particular use. In no event will Extron Electronics be liable for direct, indirect, or consequential damages resulting from any defect in this product even if Extron Electronics has been advised of such damage.

Please note that laws vary from state to state and country to country, and that some provisions of this warranty may not apply to you.

<p><b>Extron Headquarters</b> +1.800.633.9876 (Inside USA/Canada Only) Extron USA - West +1.714.491.1500 +1.714.491.1517 FAX</p>	<p><b>Extron Europe</b> +800.3987.6673 (Inside Europe Only) +1.919.850.1000 +1.919.850.1001 FAX</p>	<p><b>Extron Asia</b> +65.6383.4400 +65.6383.4664 FAX</p>	<p><b>Extron Japan</b> +81.3.3511.7655 +81.3.3511.7656 FAX</p>	<p><b>Extron China</b> +86.21.3760.1568 +86.21.3760.1566 FAX</p>	<p><b>Extron Middle East</b> +971.4.299.1800 +971.4.299.1880 FAX</p>	<p><b>Extron Korea</b> +82.2.3444.1571 +82.2.3444.1575 FAX</p>	<p><b>Extron India</b> 1800.3070.3777 (Inside India Only) +91.80.3055.3777 +91.80.3055.3737 FAX</p>
--	---	---	--	--	--	--	---