

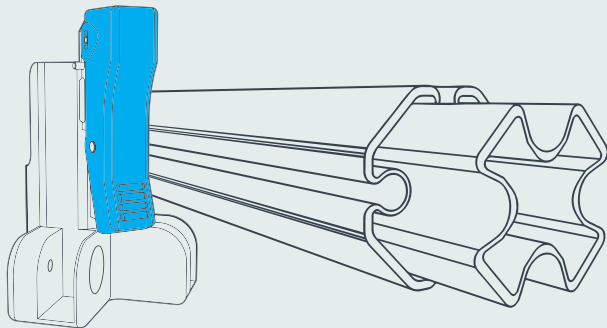

MAGICIAN SET UP

MODELS: XP220, XP330, XP345, XP360

POP UP TENT | *Magician (XP)*



Thank you for choosing the Magician.

The Magician pop up canopy tent is ideal for intensive use where there is a daily requirement to shelter areas quickly and efficiently; The XP Magician includes several LP TENT patents making this canopy tents design unparalleled. Its many strengths make it the best selling tent to date.

For an optimal use of this product we invite you to follow our setup guide.

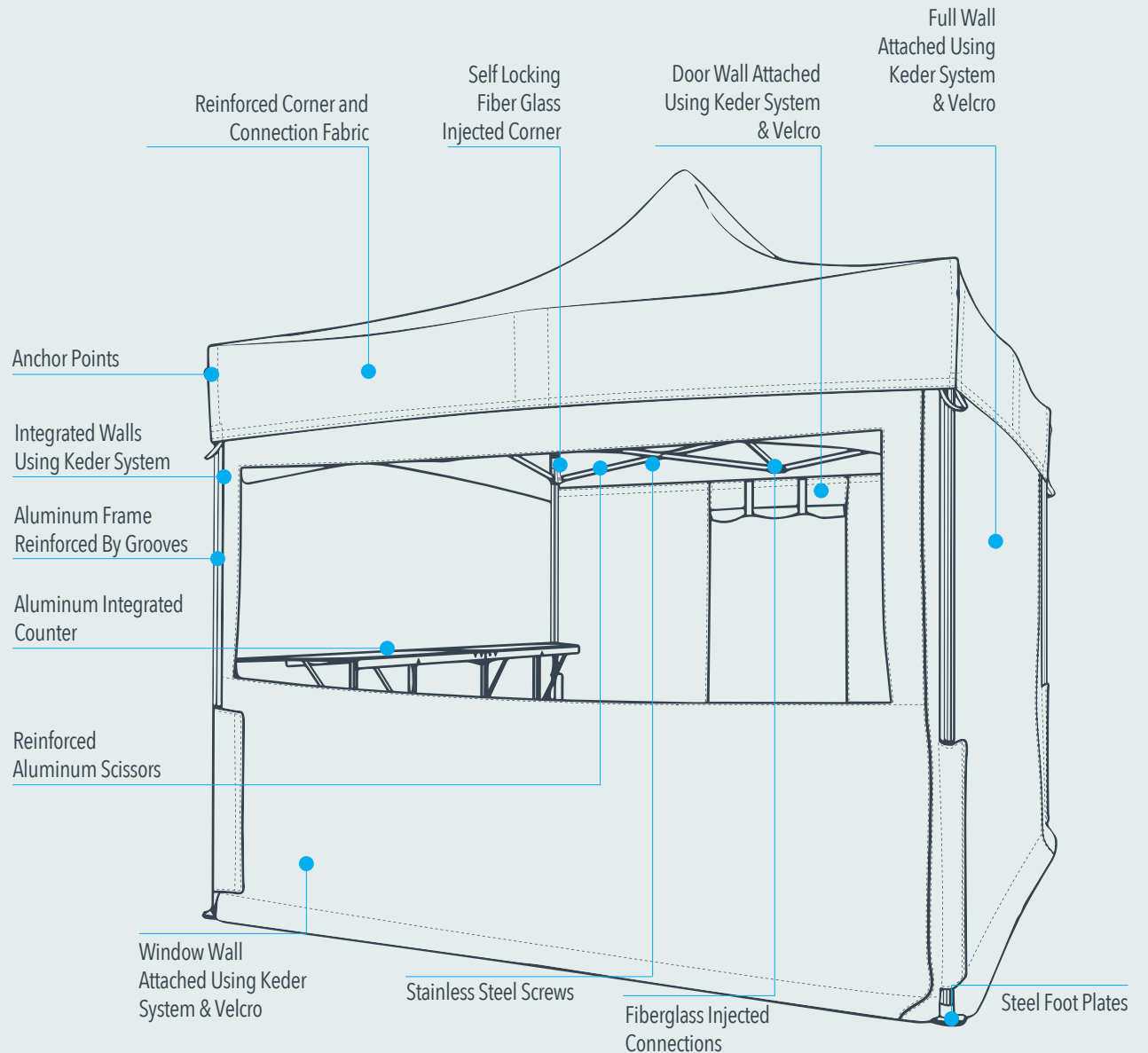

VISIT THE SUPPORT PAGE AT LPTENTUSA.COM / LPTENT.CA FOR MORE INFORMATION ON LP TENT PRODUCTS.

SET UP INSTRUCTIONS | *Magician (XP)*

TOP INSTALLATION

1 Position the frame

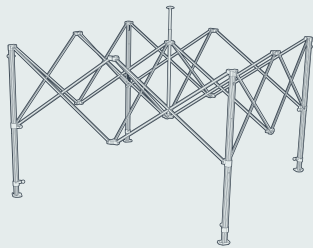

Open the frame 40% of the way

2 Position the top

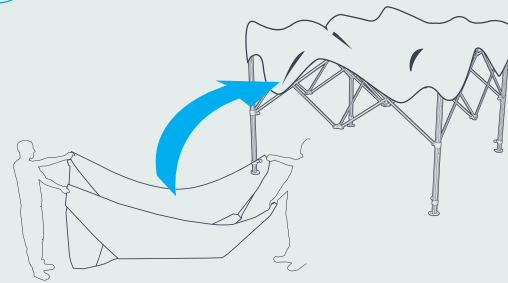

With two people, open the roof and grab at each corner. Correctly position the peak and the corners of your top.

3 Secure the top to the frame

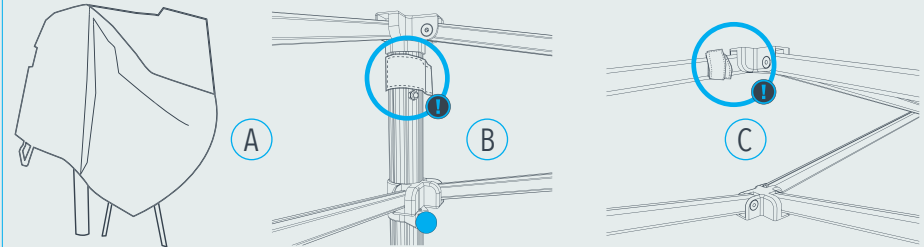

Once each corner of the top is correctly placed on the corners of the structure (A) attach the Velcro straps in the corners like as shown above (B), finally open the tent all the way and attach the Velcro straps in the center of the valences to the scissors like as shown above (C)

! Do not tighten the Velcro on the roof during the assembly of the canvas.

FRAME DEPLOYMENT

1 Position the frame



Place the tent on a flat surface, standing upright on its 4 feet. Then loosen the roof strap.

2 Deploying the structure

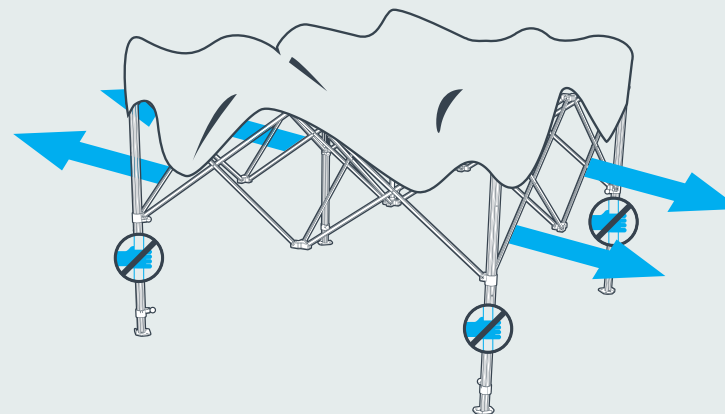

Open the structure 60% of the way then position 2 people face to face, grab the scissors and pull while backing up.

! Do not grab or pull at feet.

SET UP INSTRUCTIONS | Magician (XP)

FRAME DEPLOYMENT

3 XP automatic locking system

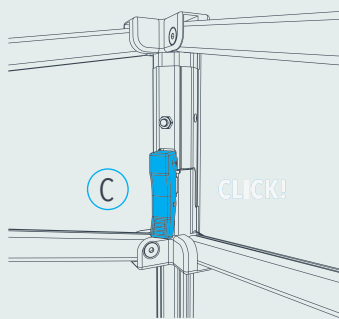
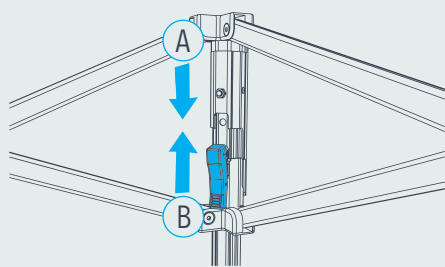

Push point (A) towards point (B) until you hear a click. Once you hear the click the XP automatic locking system will be locked into place and your tent will be secure (C). Repeat on all legs.

4 Height adjustment

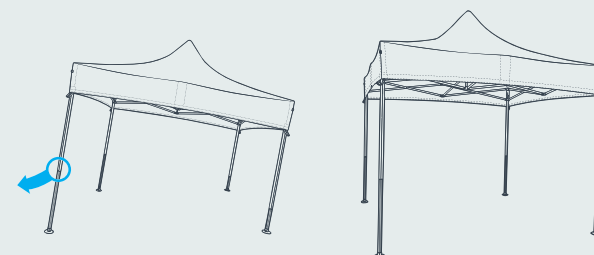
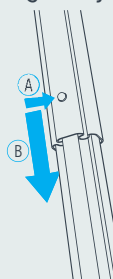

Adjust the height of the tent using the extendable legs. To do this, push the pin on the leg inwards (A) and slide the lower part of the leg (B). The lower part must slide by itself. You can choose between 3 height settings. The walls are provided for the maximum height. (When extending the legs do not stand on the foot plate)

! Do not force the frame. Close the frame and check for blockage

WALL INSTALLATION

1 Insert the wall keders into the frame

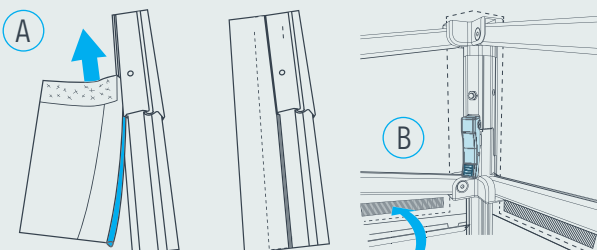

Position the wall so that the Velcro strip on the top faces the outside of the tent. Insert the keders into the frame (A) (INSERT MID FRAME) and attach the Velcro to the roof strip (B) (Inner side).

2 Attaching the wall to the bottom of the leg

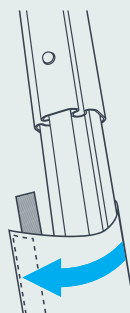

Wrap the bottom of the wall around the bottom of the leg and attach it to the inside of the wall. If there is more than one wall, attach the Velcro to the adjacent wall.

3 Opening the door/window wall curtain

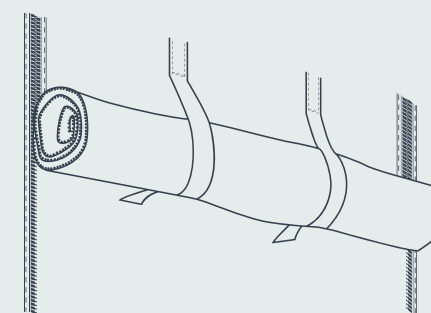

Unzip the two vertical zippers (door only), roll the door/curtain and hang it with the Velcro strips on the top of the wall.

SET UP INSTRUCTIONS | Magician (XP)

WEIGHTING & ANCHORING

1 Weighting

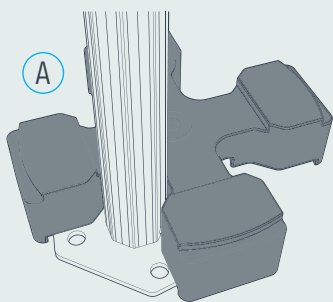

Place the weight on the foot plate of your tent (A). Stack any extra weights if necessary.

2 Anchoring

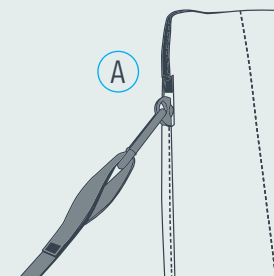

Attach the carabiners to the anchor points on each corner of the tent (A). Place the stakes at a minimum distance of 3ft.

CLEANING & MAINTENANCE

1 Cleaning the roof, walls and frame:

- Wash with a damp cloth and soapy water (no abrasive sponge or detergent).
- Rinsing possible with a hose (high pressure not recommended).
- Air dry before storing.
- To remove dirt, grass, clean the frame with a damp cloth (No detergent).

2 Storing:

- Wash and dry before storing.
- Store the tent upright in its carrying case.
- Store the material in a dry place not subject to high humidity.

3 Transportation:

- Transport the tent preferably upright.
- In case of horizontal transport, do not put weight on the structure.