

PRELIMINARY

SYVA SEGMENT SOURCE SYSTEM



- L-Acoustics line source heritage
- 142 dB max SPL down to 35 Hz
- 35 m throw capability
- Exceptional coverage capability
- Streamlined design
- Plug-and-play package



ELECTRO-ACOUSTICS



Syva is a segment source system (patent pending) suited to medium throw applications. It is designed for professional sound reinforcement and high-end residential applications requiring high fidelity and SPL with minimum visual impact.

The Syva enclosure features six 5" MF speakers providing usable bandwidth to 87 Hz and three 1.75" HF diaphragm compression drivers, loaded by DOSC waveguides in a J-shaped progressive curvature. This transducer arrangement, called segment source, produces an H/V 140° x 26° (+5/-21°) directivity pattern, optimized for ultra-wide horizontal coverage with extended throw capability.

The Syva Low enclosure features two K2 12" drivers and is designed to provide low frequency contour and extended bandwidth to the Syva system (9 dB contour with a low frequency limit at 40 Hz).

The Syva Sub enclosure features one high excursion 12" driver equipped with a KS28 woofer motor and is designed to further extend the bandwidth of the system in the sub frequency domain down to 27 Hz.

Both feature a bass-reflex cabinet equipped with L-Vents, reducing turbulence and port noise at high levels while increasing LF efficiency.

L-Acoustics amplified controllers ensure advanced crossover functions, time alignment, linearization and L-Drive protection of the transducers.

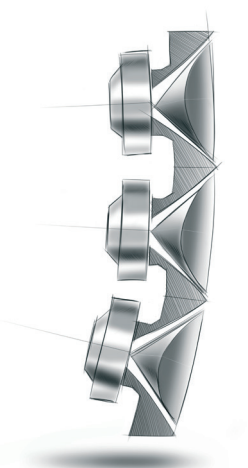

Syva combines the directivity benefits of line length and the coupling of HF DOSC waveguides to achieve a narrow vertical beam that is perfectly controlled down to 300 Hz. Syva focuses energy toward the back of the audience while providing smooth down-fill coverage to the front. Throw and SPL consistency are ensured from front, to back. The combination of extended 35 m throw and ultra-wide horizontal dispersion provides exceptional surface coverage for flat audiences.

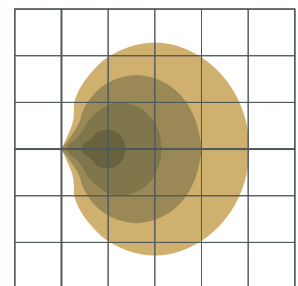
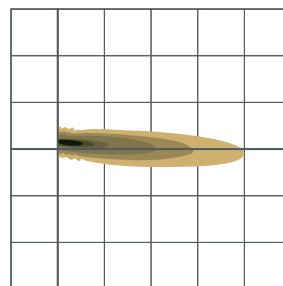

Syva vertical and horizontal SPL mappings from 1 kHz - 10 kHz. Scale: one square = 10 m (30 feet) and 3 dB per color. Design optimized for 5 to 40 m coverage, with base of Syva at 1 m above target audience zone.

PHYSICAL



The cabinet combines the remarkable acoustic properties of birch and beech plywood. Its slim elegance makes for easy integration. RAL colors allow it to blend into any architecture. Syva Low and Syva Sub provide a stable podium base for Syva. The plug-and-play AutoConnect link provides a rapid and secure audio and physical link.

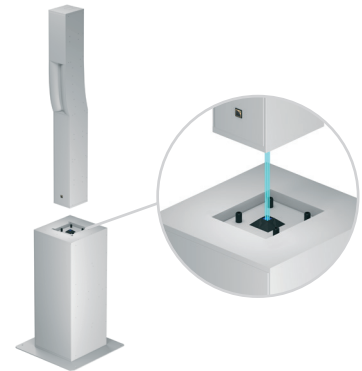

APPLICATIONS AND BENEFITS

In fixed installations Syva is particularly suited to sound reinforcement in architectural settings and acoustically challenging environments where a combination of high intelligibility, high SPL and extended bandwidth are required. Its high fidelity sonic signature and elegant lines can satisfy high-end residential projects as well as L-ISA immersive multi-channel systems.

For rental events, Syva is fast to deploy and simple to rig. Its outstanding throw capability can satisfy production needs in large spaces and ballrooms where elegance and discretion are a must.

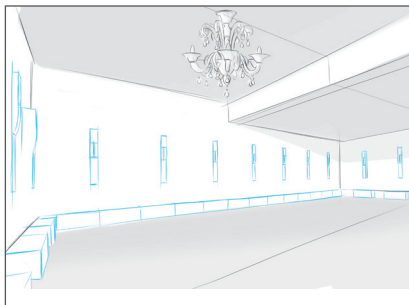

L-ISA Auditorium

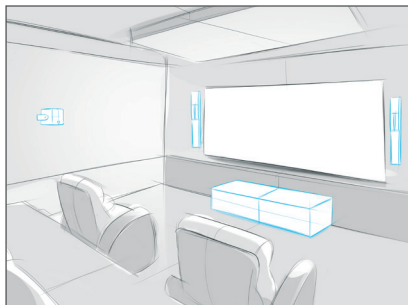

Home Cinema

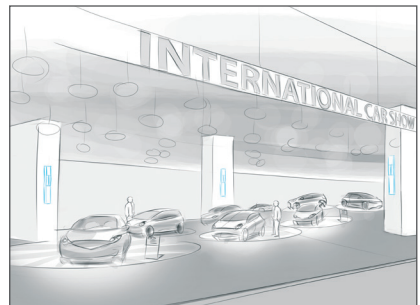

Trade Show

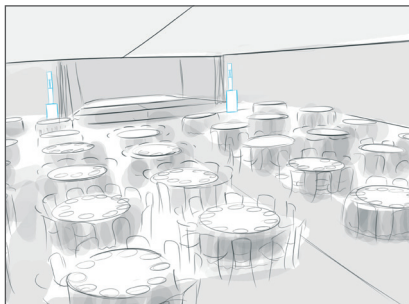

Corporate Event

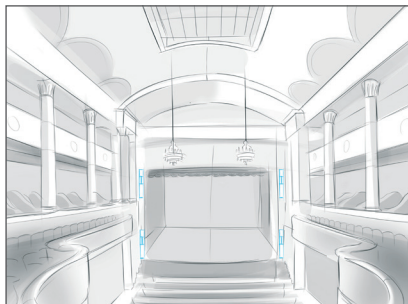

Performing Arts Center

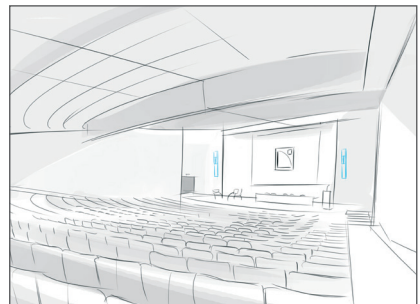

Amphitheatre

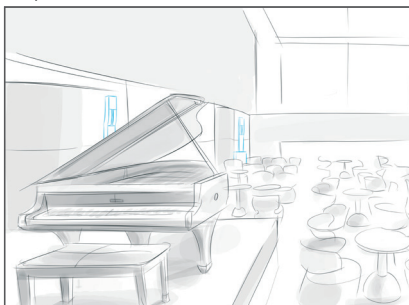

Lounge Bar

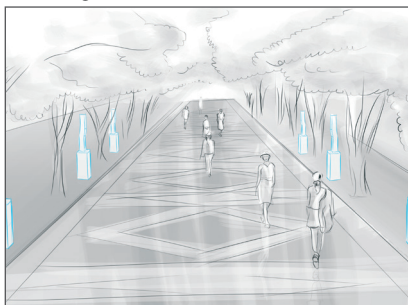

Fashion Show

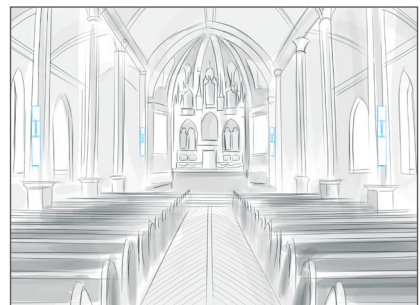

House of Worship

RIGGING

Syva can be stacked as a standalone system or secured onto one of its LF extensions. Wall-mounting and flying are also possible.

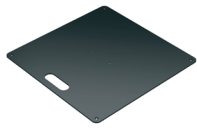

Syva Base
Baseplate for
Syva, Syva Low & Syva Sub

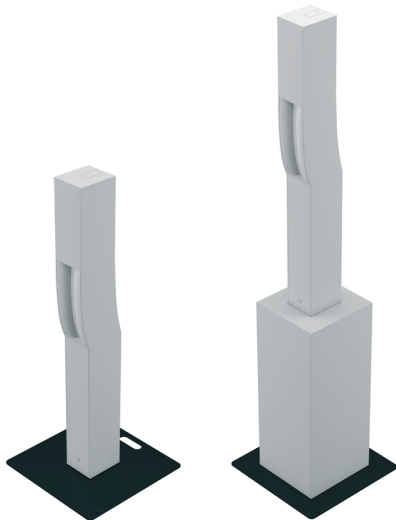

Syva Wall
Wall-mount for Syva

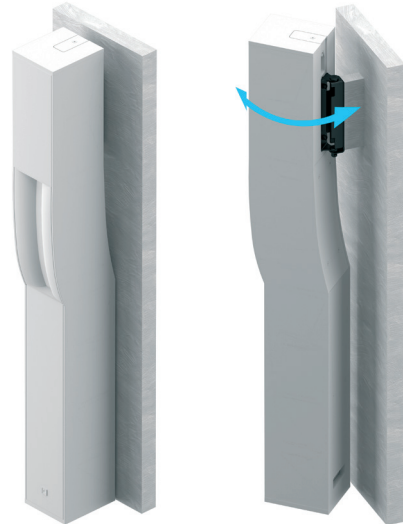

Syva Pole
Pole-mount adapter for Syva

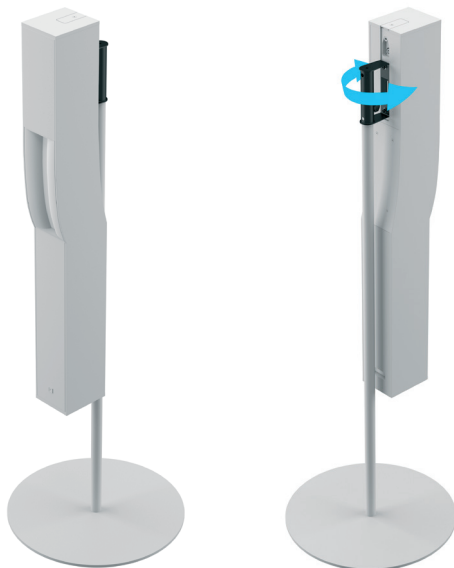

Syva Bar
Rigging bar for Syva
(combined here with Clamp250)

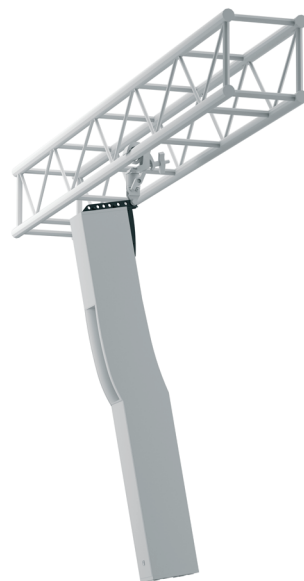

AMPLIFIED CONTROLLERS

LA4X: amplified controller with DSP

4 x 1000 W/8 ohms or 4 ohms
4 inputs x 4 outputs architecture
Max 4 enclosures per amplified controller



SUBWOOFER

Syva Low: high power subwoofer

System bandwidth: 40 Hz – 20 kHz
Ratio of 1 Syva Low to 1 Syva
Contour reinforced by 9 dB



Syva Sub: infra subwoofer

System bandwidth: 27 Hz – 20 kHz
Ratio of 2 Syva Sub to 1 Syva Low and 1 Syva
Contour reinforced by 12 dB



SOFTWARE

Soundvision: simulation software



3D electro-acoustic & mechanical simulation software

LA Network Manager: control & monitoring software



Real-time control and monitoring up to 253 units.
Multiple network topologies

SPECIFICATIONS: SYVA

Description	2-way-passive enclosure, amplified by LA4X / LA8 / LA12X
Usable bandwidth (-10 dB)	87 Hz - 20 kHz ([SYVA])
Maximum SPL¹	137 dB ([SYVA])
Nominal directivity	Horizontal: 140° (>1 kHz) Vertical: +5/-21° in J shape (>1 kHz)
Transducers	MF: 6 x 5" HF: 3 x 1.75", compression driver
Acoustical load	MF: bass-reflex, L-Vents HF: DOSC, L-Fins
Nominal impedance	8 Ω
Connectors	IN: 2-point speakON® and screw terminal AutoConnect
Rigging and handling	DIN580 - compatible M8 threaded insert for secondary safety 2 integrated inserts for rigging accessory
Weight (net)	21 kg / 46 lb
Cabinet	First grade Baltic beech and birch plywood
Front	Steel grill with anti-corrosion coating Acoustically neutral 3D fabric
Finish	Fine grain dark grey brown Pantone 426C
IP	TBD

1- Peak level at 1 m under free field conditions using pink noise with crest factor 4 (preset specified in brackets).

DIRECTIVITY/BEAMWIDTH

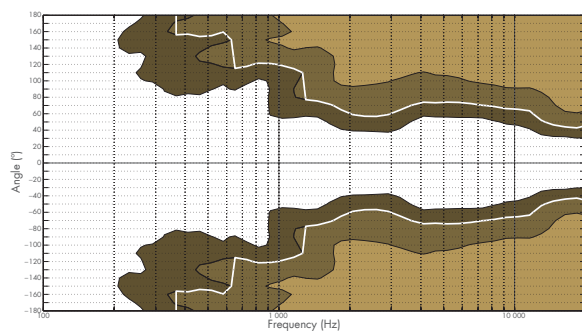

Beamwidth Syva horizontal 1/3 oct

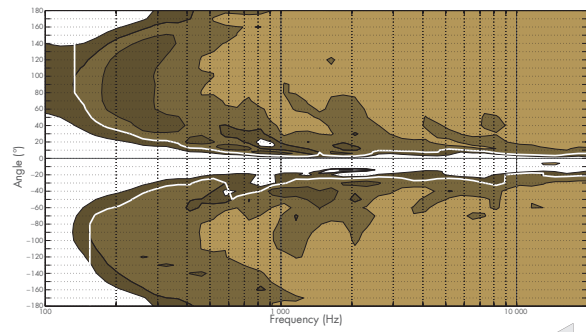

Beamwidth Syva vertical 1/3 oct



DIMENSIONS

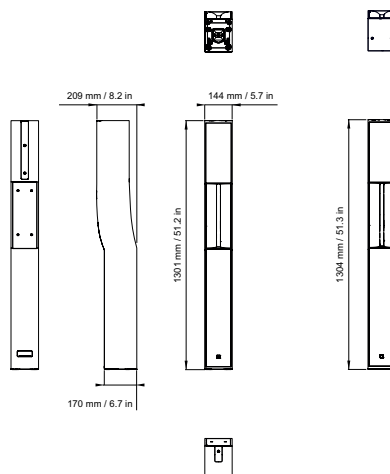

SPECIFICATIONS: SYVA LOW

Description	High power subwoofer, amplified by LA4X / LA8 / LA12X
Low frequency limit (-10 dB)	40 Hz ([SYVA LOW_100])
Maximum SPL¹	137 dB ([SYVA LOW_100])
Transducers	LF: 2 × 12"
Acoustical load	Bass-reflex, L-Vents
Nominal impedance	4 Ω
Connectors	IN: 2-point speakON® AutoConnect
Weight (net)	29 kg / 64 lb
Cabinet	First grade Baltic beech and birch plywood
Front	Steel grill with anti-corrosion coating Acoustically neutral 3D fabric
Finish	Fine grain dark grey brown Pantone 426C
IP	TBD

1- Peak level at 1 m under half space conditions using pink noise with crest factor 4 (preset specified in brackets).

SPECIFICATIONS: SYVA SUB

Description	Infra low frequency subwoofer, amplified by LA4X / LA8 / LA12X
Low frequency limit (-10 dB)	27 Hz ([SYVA SUB_100])
Maximum SPL¹	128 dB ([SYVA SUB_100])
Transducers	LF: 1 × 12"
Acoustical load	Bass-reflex, L-Vents
Nominal impedance	8 Ω
Connectors	IN: 2-point speakON® AutoConnect
Weight (net)	27 kg / 60 lb
Cabinet	First grade Baltic beech and birch plywood
Front	Steel grill with anti-corrosion coating Acoustically neutral 3D fabric
Finish	Fine grain dark grey brown Pantone 426C
IP	TBD

1- Peak level at 1 m under half space conditions using pink noise with crest factor 4 (preset specified in brackets).

DIMENSIONS

